

HYDRA-PAK Model 270

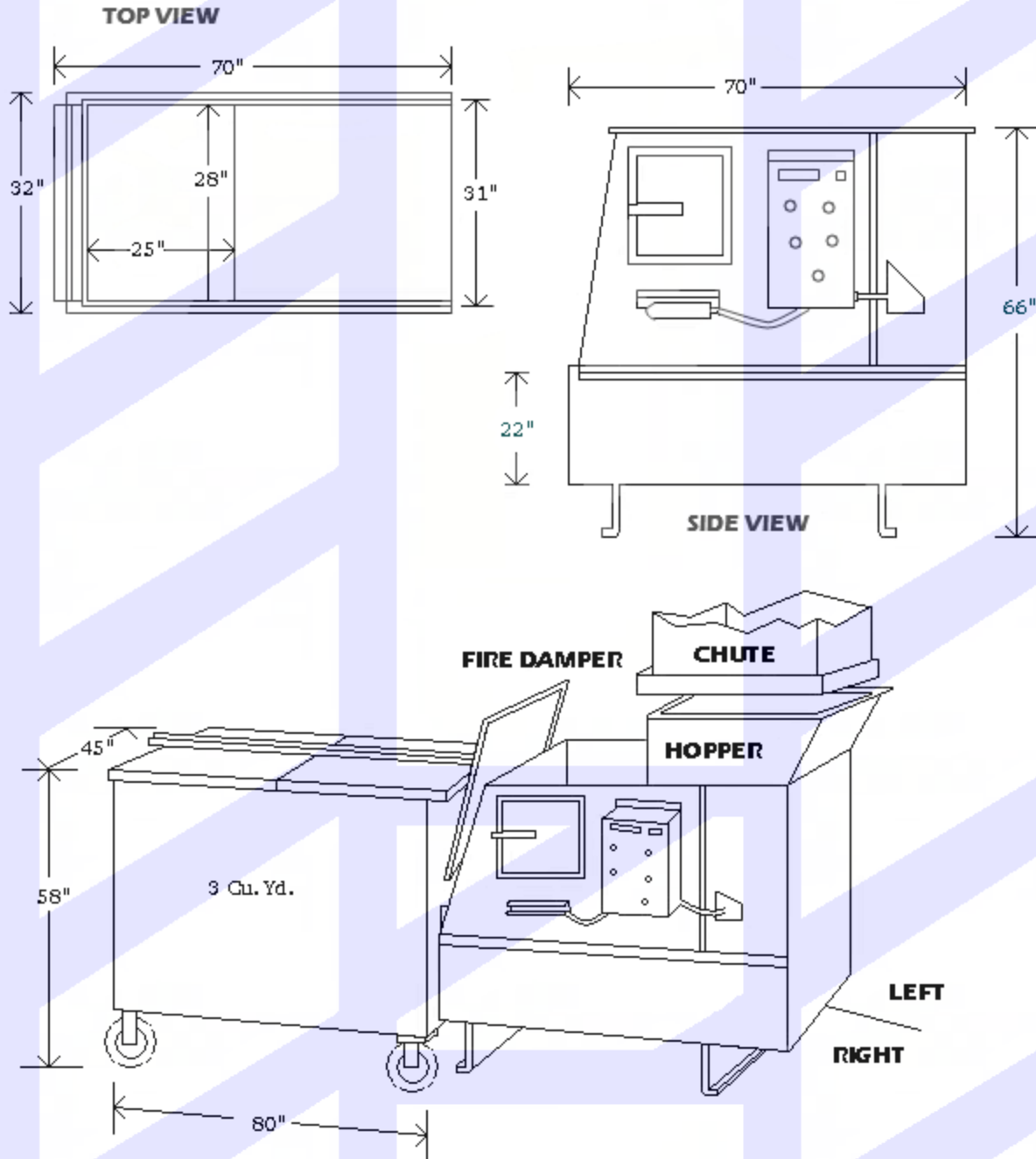

Clear Top Opening: 28" x 25"	Factory Rating: .38 Cu. Yd.	Motor: 3 HP	Pump: 3 GPM
No. of Cylinders: 1	Cylinder Bore: 3.5"	Ram Stroke: 30"	Max. Pressure: 1200 PSI
Ram Face: 504 Sq. In.	Ram Face Pressure: 30 PSI	Cylinder Force: 15,000 lbs	Cycle Time: 30 seconds
Base Unit Weight: 2,100 lbs			

**Specifications are approximate and subject to change without notification.
Dimensions will vary with options in Compactor and Container size.**

HYDRA-PAK SYSTEMS LIMITED
 2501 Beryl Road
 Oakville, Ontario, L6J 7X3
 Tel: 905-844-7844
 email: look@hydrapaksystems.com