

Silica Fume

By Gary M. Gapinski and John Scanlon

In the Refractories world thirty-five years ago, no one was working with silica fume and few knew what it was. Within a few years, it was being used as an additive to brick. When added to high Alumina brick, mullite was formed in the matrix of the brick on firing, giving the brick good volume stability, strength and chemical resistance. When used in basic brick, high hot strengths resulted, at least at 2700°F, which was about the limit of what could be tested. At the time it was only logical that silica fume would be used in brick not castables. Brick were used for all critical applications, no one would have considered using castables. Today's refractory castables have gone beyond having "brick-like properties" to actually out performing brick in many applications. Silica fume has played a major role in this transformation.

History

The history of silica fume is relatively short, the first recorded testing of silica fume in Portland cement based concretes was in 1952 and it wasn't until the early 1970's that concretes containing silica fume came into even limited use. The biggest drawback to discovering the unique properties of silica fume and its potential was a lack of silica fume to experiment with. Early research used an expensive additive called Fumed silica, a colloidal form of silica made by combustion of silicon tetrachloride in hydrogen-oxygen furnaces. Silica fume on the other hand, is a by-product or a very fine pozzolanic material, composed of mostly amorphous silica produced by electric arc furnaces during the production of elemental silicon or ferro silicon alloys. Before the late 1960's in Europe and the mid1970's in the United States, silica fume simply went up the stack as smoke vented into the atmosphere (Illustration #1).



Illustration # 1

Only with the implementation of tougher environmental laws during the mid-1970's did silicon smelters begin to capture and collect the silica fume, instead of sending it to the landfill. Thus the push was on to find uses for it. Obviously, the early work done in Norway received most of the attention, since it had shown that Portland cement based concretes containing silica fumes had very high strengths and low porosities. Since then silica fume usage and development has continued making it one of the world's most valuable and versatile admixtures for concrete and cementitious products. Typically purchased by the refractory market in a 50 lb. bag this very fine gray powder (Illustration #2) has come along way from being known only as "smoke".



Illustration # 2

Silicon Smelting

To understand silica fume, one must first understand the smelting of silicon metal. Silicon is smelted in large submerged arc electric furnaces (Illustration # 3). A typical 20 MW furnace might be as large as 40 feet in diameter and 15 feet deep. There are 3 electrodes, which could be up to 60 inches in diameter.



Illustration # 3

The furnace charge is quartzite, charcoal, wood chips and coal. The quartzite used for smelting silicon must be very pure and contain more than 99% silicon dioxide. The quartzite is usually river rock that has been very carefully washed to remove any fines. Typically, this rock is between 1 and 4 inches in diameter. The coal must also be very pure and washed to remove any fines. Alkalies and iron are undesirable tramp elements. The proper ratio of coal, quartzite, wood chips and charcoal are continuously added to the top of the furnace while silicon metal is tapped from the bottom. The coal, charcoal and wood chips provide an extremely reducing atmosphere near the bottom of the furnace and especially around the ends of the electrodes. Hot gases rising through the burden preheat it and the extreme temperature at the tips of the electrodes volatilizes the quartzite when it gets close to them. This silicon dioxide vapor reacts with the now porous, pure carbon to form carbon monoxide, silicon monoxide, silicon carbide and eventually silicon metal. The carbon monoxide gas rises through the burden and oxidizes to form carbon dioxide at the top of the furnace, where the atmosphere is oxidizing. More than three pounds of carbon monoxide are produced for each pound of silicon. Just like the carbon monoxide, silicon monoxide gas also rises through the burden. If the porous carbon phases don't strip away the last oxygen molecule, the silicon monoxide will eventually reach the oxidizing zone. While the carbon in the reducing zone of the furnace strips the oxygen from most of the silicon monoxide, some of it does escape to the upper reaches of the furnace and the reaction of silicon monoxide to silicon dioxide gives us silica fume.

The silica fume that reaches the top of the furnace is sucked up into the hood that covers the top of the furnace by powerful bag house fans (Illustration # 4).

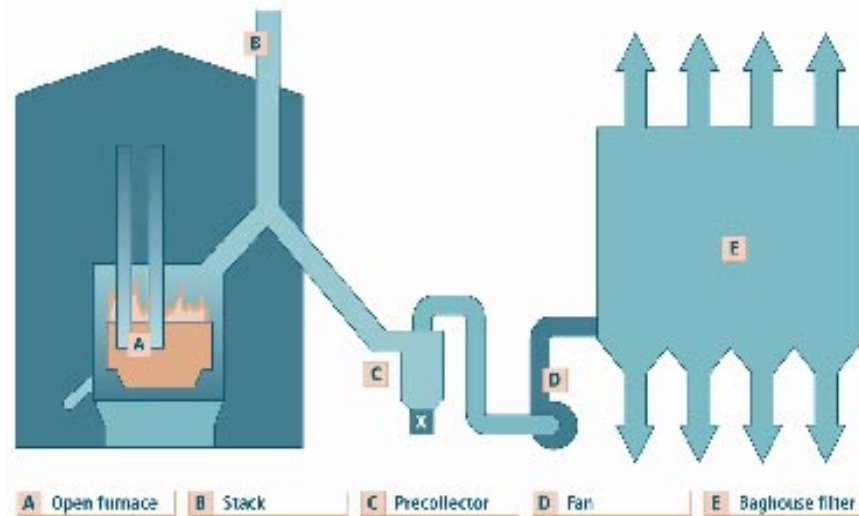

Illustration # 4

In order to meet very stringent environmental regulations, the bag house fans need to provide enough of a vacuuming action at the top of the furnace, so that no gases escape into the atmosphere and this does cause some problems. One of the reasons that the quartzite and coal are washed to remove the "fines" is so there will be no fines to be swept up the stack with the fume. Obviously, there are some fines still present and they do get pulled up the stack. For the silicon smelter, this isn't a problem. But for silica fume consumers an excessive presence of fine quartzite and coal contaminants places the end

product outside of specification limits. These are tramp elements or oversize materials that you don't want in your silica fume. On the other hand, what does concern the silicon smelters is that partially ignited wood chips, are also routinely pulled up the stack. Smoldering wood chips and bag houses just don't mix, so we have to separate the coal fines, quartzite fines, and wood chips, better known as "Heavies" from the silica fume. This is done first in the coolers and then in a series of cyclones that drop out all of the "Heavies". After this cleaning and cooling operation, silica fume is captured on the bags in the bag houses (Illustration # 5). The bags can be shaken or the compartment of the bag house backwashed to knock the fume from the bags. The fume is then moved into a silo either pneumatically or with a screw conveyor.

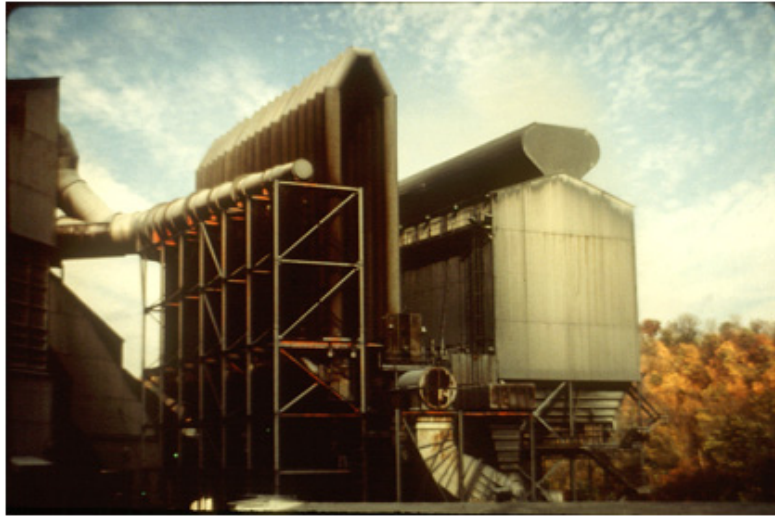

Illustration # 5

Processing and Handling

Typically the plants will have two different silo setups, one is for the storage, bulk loading and packaging of undensified silica fume and the other for the storage, bulk loading and packaging of densified silica fume. Undensified silica fume is the "as is" product that most Refractories use regularly, where as the densified product is made using undensified silica fume and some additional processing steps. The majority of densification silos have a very fine screen that covers the bottom section upon which the silica fume rests. Air is blown into the silo under the screen. This air gently rises through the silica fume causing the individual silica particles to rub against each other. As the particles touch, the naturally occurring van der Waals forces on their surface cause the particles to be attracted to each other. This attraction causes the particles to adhere to each other. The longer the air is allowed to flow through the fume bed, the greater the degree of agglomeration and correspondingly the density. Once the desired density is reached, the airflow to the silo is stopped. The newly densified silica fume can be shipped in bulk in pneumatic trucks, in super sacks or in small (usually 50 lb.) paper bags. The value of the densification process is most evident in shipments over long distances and especially for off shore customers because it greatly reduces the cost to transport 40 lbs/ft³ silica fume versus 15 lbs/ft³ material.

The end use of silica fume determines what form, densified or undensified, the consumer needs. The undensified fume in the bag house has a loose fill density of between 4 and 8 lbs/ft³ very similar to talcum powder. By the time the fume gets to the silo, moves to the bagger, is blown into the bag, the bags stacked onto a pallet and the pallet shipped to the customer, that density has increased to 12 to 18 lbs/ft³. Part of this density increase is due to the removal of air voids from between the individual silica fume particles, during handling. Another factor contributing to the density increase is caused by the stacking and subsequent compaction in the bags during shipping. In comparison densified silica fume typically has a density in the range of 40 lbs/ft³, looks like small beads, flows like water and produces very little dust. The largest consumer of undensified silica fume is the refractories industry. However, not all refractory producers use undensified silica fume. Some have been very successful in developing technology that allows them to use 40 lbs/ft³ densified silica fume to take advantage of the benefits of reduced shipping costs.

Properties of Silica Fume Concretes

Small particle size, high surface area and high silicon dioxide content are the properties of silica fume that make it so unique. However the round or spherical shape of silica fume particles has a great significance in the flow ability of the mix for both refractory castables and Portland cement based concretes. The average particle size of silica fume is about 100 to 150 times smaller than the average particle size of Portland cement and much smaller than any other component in a refractory castable. This submicron size allows the silica fume to fill the open voids in concretes and refractory castables thus decreasing the permeability of the end product. Designers use the fine size to develop mixes that flow very well through manipulation of the matrix. The large surface area of the silica fume posed a problem for designers in the early days of research. They found that in order to wet this large surface area, much more water was needed to get the same slump (flow) as mixes without silica fume. This problem was solved through the use of superplasticizers also known as High Range Water Reducing Agents (HRWRA). Most Superplasticizers fall into one of the following chemical formulations polyacrylates, sulphonated naphthalene-formaldehyde concentrates, sulphonated melamine formaldehyde concentrates, polycarboxylates and modified lignosulfates. With the addition of these chemical additives, silica fume concrete has advanced far beyond the expectations of early designers allowing for greater flexibility in design, shapes and performance. In fact, today Portland cement based concretes incorporating Pozzolans such as silica fume and fly ash in combination with superplasticizers are known as High Performance Concretes (HPC).

In High Performance Concretes, silica fume is used for its chemical and physical benefits. The chemical reaction known, as the "Pozzolanic" reaction, takes place when the Portland cement is hydrated (mixed with water), producing many compounds, including calcium silicate hydrate (CSH) and calcium hydroxide Ca(OH)₂. The calcium silicate hydrate (CSH) sometimes called the gel is the source of strength in concrete. When silica fume is added to fresh concrete, it chemically reacts with the calcium hydroxide Ca(OH)₂ to produce additional calcium silicate hydrate (CSH). The benefits of this reaction can be seen in the crucial interfacial zone increasing the bond strength between concrete paste and aggregates, yielding greatly increased compressive strengths

and a concrete that is more resistant to attack from aggressive chemicals than the weaker calcium hydroxide found in ordinary portland cement concretes.

The physical benefits imparted from silica fume additions to concretes come from particle size. Because silica fume is 100 to 150 times smaller than a cement particle, it can fill the voids created by free water in the matrix. This particle packing effect refines the microstructure of the concrete, creating a much denser pore structure, thereby dramatically increasing the impermeability of the concrete by reducing the number and size of capillaries that would normally allow contaminants to infiltrate the concrete.

Testing

The testing of silica fume can be both challenging and interesting. As previously stated particle size distribution and surface area are very important characteristics of silica fume. The standard laser test to determine particle size distribution for silica fume has recently been questioned in some literature, because the agglomerates of silica fume are too difficult to break up. Alternately gauging particle size based on surface area as determined by nitrogen absorption was recommended as the most reliable test. Logically, both measurements are important. Surface area correlates very well to how reactive any given powder will be. Particle size distribution correlates well with particle packing and flow in castables.

What is not discussed in literature is the reality that there are two types of bonds in the agglomerated silica fume. The first is an engineered weak bond made during densification held together by van der Waals forces designed to break down easily during handling and mixing. The second type is much stronger and thus more difficult bond to break apart using conventional means. The stronger bonded agglomerates are produced during silicon smelting where the silicon dioxide is vaporized low in the furnace under very intense reduction conditions. As silicon dioxide is reduced to silicon monoxide the silicon monoxide begins to slowly rise through the burden in the furnace. If the silicon monoxide is not reduced to silicon, it will reach an oxygen rich area and re-oxidize to silicon dioxide. As this newly formed silicon dioxide continues moving up through the furnace, it encounters the cold burden and gives up its heat. At some point the silicon dioxide becomes a liquid and then a solid. If the solidification process takes place while the silicon dioxide particle is in contact with another particle or two, they freeze together. With the many millions of sub micron silicon dioxide particles in the furnace, this contact happens regularly. A good example of these stronger bonds is seen when an un-experienced laboratory tries to analyze silica fume for particle size distribution. The lab will use certified standards to calibrate their equipment and set procedures for running the testing, but the equipment and procedures are not adequate to achieve dispersion of the stronger bonded agglomerates of silica fume. Typically they use a small amount of silica fume placed into a beaker of water with a couple of drops of dishwashing detergent as the surfactant. Next a 100-watt ultra sonic probe is inserted into the beaker to disperse and de-agglomerate the silica fume for two minutes. Then a sample is pulled from the beaker and placed into their particle size analyzer for testing. The results attained usually include a graph and maybe some particle size data charts, which have little to do with the actual particle size distribution of the fume because it has not yet been broken down.

The key to proper and accurate particle size distribution measurements of silica fume lies in using the right equipment and surfactants. For instance we use a custom-built laser scattering particle size analyzer with built in 600watt ultrasound and a 0.010% sodium pyro-phosphate solution. Figure #1 shows a particle size distribution using this equipment for “as received” silica fume.

Figure #1

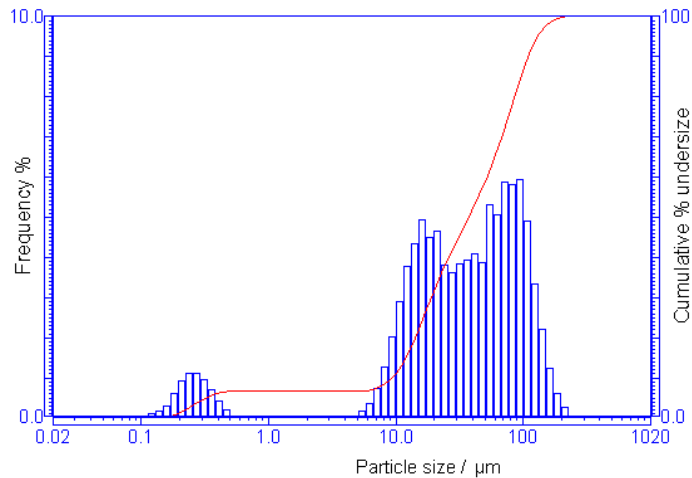

As you can see, there is a large amount of agglomerated particles showing up as having average particle sizes of between 10 and 100 microns. The double peak on this analysis is classical for silica fume and the 2 distinct forms of agglomerate bonds mentioned above show up separately. Figure #2 shows the same sample after 2 minutes of 600-watt sonification to break the bonded agglomerates. The dispersed agglomerates are very evident.

Figure #2

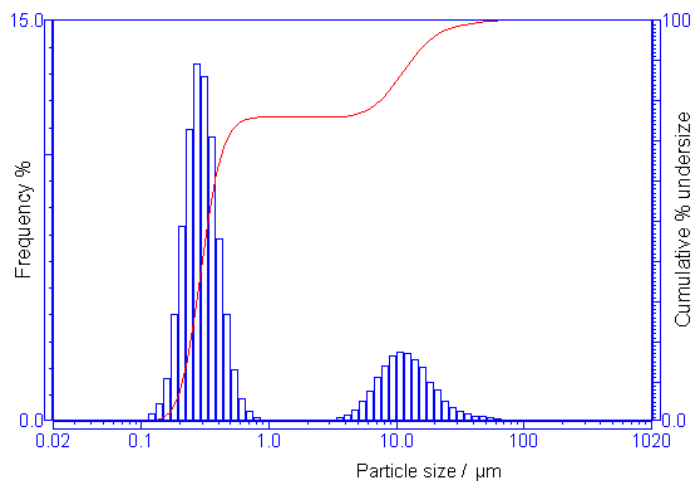

Finally, after 9 minutes of additional ultra sound, all the agglomerate bonds that can be broken apart have been dispersed. This can be verified in two ways, by comparison with BET surface area analysis and by continuing to run the particle size analysis until there is

no change in the results over consecutive runs, Figure #3 shows a fully dispersed silica fume particle size analysis as noted by the reversed peaks from Figure #1.

Figure #3

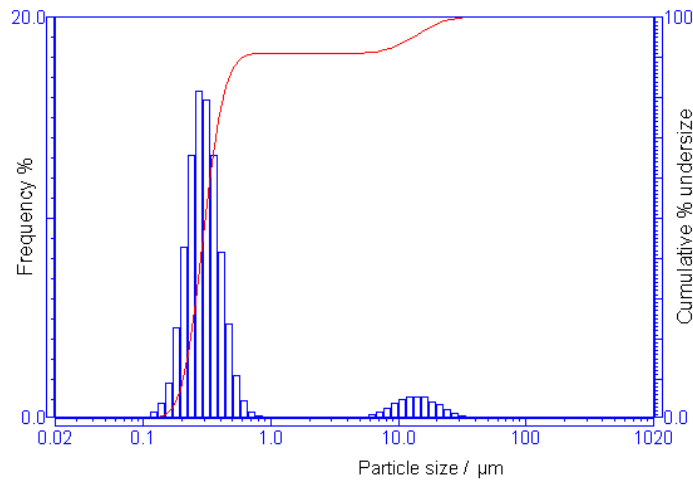

Another testing area where confusion exists is in determining the chemical composition of silica fume. For example take the case of an offshore silica fume consumer who had a specification stating that the silicon dioxide content needed to be at least 96%, a number well within normal variability for silicon dioxide content, although it is on the high side. The supplier appeared to have no trouble supplying the 96% minimum based on the supplied shipment analysis. But upon further review of the shipment analysis for the last eight loads, it was noted that LOI wasn't accounted for and the analysis always added up to exactly 100%. By simple computation it was determined that the supplier dried the sample, analyzed for five elements listed on the report and subtracted the total content of those five elements from 100 to get the silicon dioxide content. Not exactly the proper method of chemical analysis. Producers of silica fume use several means of analysis from classical wet chemistry to Inductively Coupled Plasma (ICP) Direct Coupled Plasma (DCP) X-Ray Fluorescence Spectrometry (XRF) and Flame Atomic Absorption Spectrometry (FAAS) to achieve this task with a very high degree of accuracy. To further improve analysis used by silica fume manufacturers the National Institute of Standards and Technology (NIST) in collaboration with the Silica Fume Association (SFA) released a new Silica Fume Reference Material (SRM)[®] # 2696 in May of 2004. The Silica Fume Standard Reference Material was generated in response to the increased usage of silica fume as part of High Performance Concrete (HPC) and the lack of suitable calibration or reference materials to accurately measure the required chemical and physical test parameters. The 5-year project was initiated by the Silica Fume Association and developed with NIST to provide certified and reference values for Silica Fume. Certified values are now established for Silicon Dioxide (SiO₂) and six other major chemical constituents with reference values provided for another 5 chemical constituents and the physical measurement parameter for Specific Surface Area (BET). All Values are a product of extensive round robin testing by a group of participants representing State Department of Transportations, Universities, Commercial Test Laboratories, Distributors and Manufacturers. The new Standard Reference Material is applicable for calibration curves, validation of existing laboratory values, confirmation of laboratory practices and simplifying the test process through standardization.

For the Refractories industry one of the most important tests for silica fume is the pH the lower the value the better. In order to run a valid pH test of silica fume you should know that calibration of your pH meter requires the use of buffered solutions with known pH levels prior to running the analysis. Surprisingly not everyone practices this simple step. Field investigations have noted instances, where silica fume was tested using the pH=7, buffered solution as the carrier liquid for the test thus giving undesirable results. In other cases it has also been observed that arbitrary dilution levels (1:100, 1:2, 1:10, 0.5:30) are used regularly also affecting a pH readings and yielding varied results. This seems to be an area where a standard test procedure could and should be developed.

Silica Fume and all other Pozzolans used in concrete applications are typically subjected to “product specific” testing called the Pozzolanic Strength Activity Index with Portland cement (PSAI). The purpose of this test is to determine a value by ratio (expressed in percent) as to the reactivity of a specific Pozzolan. The test is a simple mortar test using standard Portland cement and Ottawa silica sand to produce a set of cubes identified as the control mix. A second set of cubes (test mix) is produced using the exact same Portland cement and Ottawa silica sand, incorporating a precise amount of a Pozzolan and in the case of silica fume superplasticizer. After curing the cubes for the appropriate time as specified by ASTM, the cubes are broken in compression and the pozzolanic strength activity index is calculated as follows; $PSAI = \frac{\text{the average cube breaks from the test mix}}{\text{control mix}}$. It is important to note that each different Pozzolan has its own variation of this test specified in ASTM. The differences between the various Pozzolans are noted in terms of percent Portland cement replacement, water to cement ratio, flow measurement range, additional ingredients (superplasticizers if required) and length or method of cube curing before breaks.

Corrosion of reinforcing steel is one of the most costly and significant causes of reinforced concrete deterioration. Whether from deicing salts, seawater exposure or any other source, it doesn't matter where the chlorides come from the results are the same. The chlorides eventually work their way into the concrete and ultimately down to the reinforcing steel. Once enough of the chlorides ions contact the steel, corrosion begins as in Figure #4.

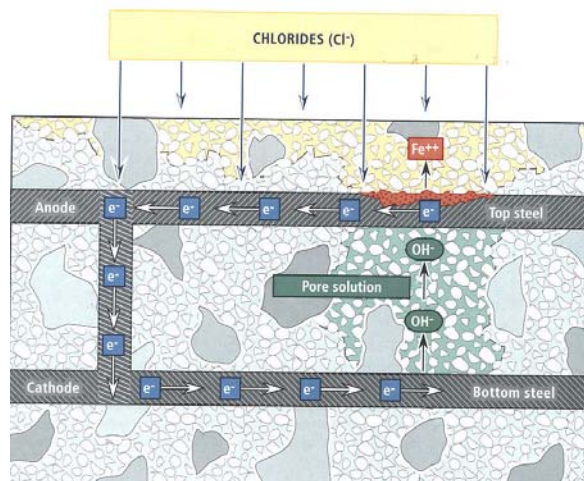

Figure #4

Over time, depending on the amount of available chlorides, the reinforcing steel will release iron ions through oxidization or rusting. As the amount of rusting increases, rust stains become visible on the concrete surface, followed by cracking and delaminations and spalling of the concrete. Examples of this can be seen while driving down the highway in structures such as bridge decks, columns, support structures and piers. When originally designed most of these structures were produced with ordinary Portland cement concrete and expected to have a service life in the range of 25 to 30 years. Today similar structures are being built using High Performance Concrete incorporating silica fume with an extended service life of 50 to 100 years.

With the concrete technology advances, and the identification of problem areas test methods needed to evolve to keep pace. The test method most commonly used for testing chloride penetration is ASTM C 1202-97 Electrical Indication of Concrete's ability to resist Chloride Ion Penetration. This method is a means of evaluating the electrical conductivity of concrete samples and gives an early indication of the concrete's ability to resist the chloride ion penetration. The method uses two slices 2-in (51-mm) thick taken from 4-in (102-mm) diameter cylinders or cores. The difference of a constant electrical current (60 +/-0.1 V dc) is applied for a 6 hour monitoring period with one sample immersed in a sodium chloride (NaCl) solution and another immersed in a sodium hydroxide (NaOH) solution. The total charge passed in coulombs indicates the resistance of the concrete to chloride ion penetration. A diagram is given in Figure 5.

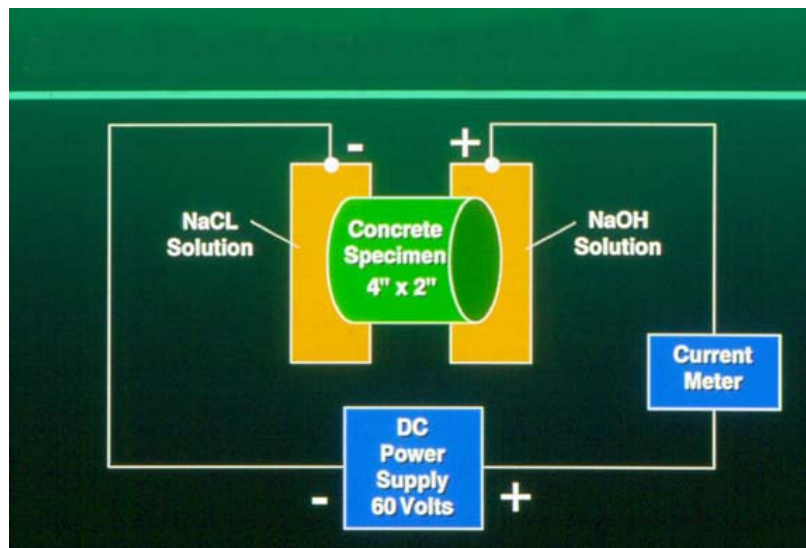

Figure 5

Tests of ordinary Portland cement concrete can have an average coulomb value of 4,000 or greater which is considered as high chloride permeability, while silica fume concrete will yield values around 500 coulombs or very low chloride permeability. This improvement in chloride resistance translates to longer times to corrosion and longer service life for concretes made with silica fume.

Silica Fume In Various Applications

Silica Fume usage is varied and open to the imagination of the designers. It has become

an integral part of many of the items we use in our daily life. In this section we have chosen some of the applications that demonstrate the versatility of the product. From High Performance Concrete (HPC) in construction projects to filler in lawn care products it is rather amazing how far this “smoke” by-product has evolved.

The earliest applications for high-strength silica fume concrete were in columns for High-rise structures (Illustration # 6). As concrete strength increases column size can be reduced and reinforcing steel designs in the columns can be simplified. Smaller columns equates to more overall floor space available to the owner of the structure and a significant cost advantage, particularly in urban settings.



Illustration # 6

Cast in place parking garages also moved quickly to incorporate High Performance Concrete into the structures (Illustration # 7). From a design standpoint it's used for many of the same reasons as high-rise structures. However in this case service may be the most important factor, which is greatly affected by the parking decks susceptibility to chloride attack. The problem is caused by salt in the melting snow. Salt laden snow builds up on cars during driving in the inclement weather, when these cars eventually park in a garage the snow and salt melts leaving puddles of salt enriched water to seep into the concrete eventually attacking the reinforcing steel and causing deterioration of the concrete. By using High Performance Concrete designers have found that the situation can be mitigated due the decreased porosity and increased durability of the HPC concrete.



Illustration # 7

Marine applications are another area where resistance to chloride penetration is critical. Direct salt-water contact (Illustration # 8) as well as airborne sea salts effect structures such as; Pilings for bridges, wharfs, piers, break walls, and bridge decks. This structure would have been better prepared to resist the aggressive salt environment if silica fume HPC concrete was used in the construction..



Illustration # 8

Many chemical plants use silica fume in their concrete for the reduction in permeability and increased durability. They find that this concrete is much more resistant to attack by acids or other aggressive chemicals. Slowing down the rate of deterioration or time between repairs in extremely aggressive chemical processing areas. Additional benefits also come from the higher strength and increased abrasion resistance.

Nuclear waste storage facilities (Illustration # 9) because of their massive size and complex design have found silica fume concrete as a valuable component. By adding silica fume to the concrete during the placement of these structures, designers have been able to achieve high early strength for form stripping, long life, and controlled temperature gain for the concrete.



Illustration # 9

Oil well grouting is another area where silica fume is used extensively. In both primary oil well grouting, when the grouting is used as a hydraulic seal in the well bore and secondary grouting such as leak repairs, sealing splits, and closing depleted zones. The addition of silica fume to the oil well grout produces a blocking effect that prevents gas migration. Silica fume's ability to decrease the permeability of the grout, slows or stops gas leakage from the well. Increased strength of the cured slurry provides greater durability of the installation and the addition of silica fume to the slurry, improves its flow, so the installation is more effective.

Shotcrete applications such as tunnels, mines, tanks, repairs and domes use large quantities of silica fume. The increased cohesion from silica fume allows for greater application thickness, particularly overhead, significant reduction in rebound and increased flexural strength. In the construction industry, shotcreting can be either wet or dry. Dry shotcreting is gunning in refractory terminology and wet shotcreting is shotcreting. The equipment is the same for both industries as are the installation techniques. Usually wet shotcreting is the installation method of choice because the water is precisely controlled when added to the dry mix in the transit truck, not at the nozzle tip by the applicator as with gunning. In addition there is less rebound with wet mix which translates into a faster installation. Coupled together no rebound and the nozzle man not in control of the water addition, means a more consistent installation.

In the tidal repair of piles and seawalls, the improved cohesion of the shotcrete to itself means greater resistance to washout. Silica fume provides higher bonding strength for rehabilitation projects. Lower permeability plus proper air entrainment results in better freeze thaw durability. Silica fume concrete's high electrical resistivity mitigates reinforcing steel corrosion in chloride rich environments. Bridge columns are a good example of concrete deterioration from the use of road salts (Illustration # 10).



Illustration # 10

Concrete roofing tiles and siding is an application that has embraced silica fume. Six years ago, the Japanese export market grew substantially. They had become very conscious of the harmful effects of the asbestos that was an integral part of these construction products in their country and needed to remove it. Research determined that

silica fume would impart the same properties to these construction products as did the asbestos and a new market was opened.

Fertilizers use silica fume along with the weed and feed in order to provide added volume to the fertilizer. It helps in the pelletizing process, provides strength to the fertilizer pellets and causes no harm to your lawn, pets or children. It can also be found in some granulated herbicides.

Rubber and plastic industries also consume silica fume. It is an essential part of the “rubber compound” used to make tires. Silica fume is also a critical compound for the companies making golf balls and for many other plastic and polymer producers. Silica fume adds to the tensile strength and elongation of these rubber products.

Another interesting use for silica fume is in the manufacture of “dry wall”. Gypsum based wallboard comes in many forms. The standard grade is used in most of the rooms of your house; a water resistant board used in bathrooms and laundry rooms; and a fire retardant grade used around furnaces and hot water heaters. We have been told that silica fume aids in the flow ability of these products during production. But the main use of Silica fume is in the fire retardant grades because of its heat resistance capabilities.

As you can see the areas of use for silica fume and silica fume high performance concrete are continually growing as technology advances. New products are engineered and designed almost daily and so the calls come in for samples and information on silica fume. Where it will end up is anyone’s guess. However to date silica fume manufacturers are pleased with the advancements made using this by-product that was once just tossed in a landfill.