

# Surgical Product Catalog

**NOT ALL PRODUCTS ARE AVAILABLE IN CANADA  
DUE TO HEALTH CANADA LICENSING REQUIREMENTS**

[sacor.ca](http://sacor.ca)



Sacor Inc.

1-800-263-3557

# About Us

Accutome is entering our fourth decade in the ophthalmic industry. The three major traits that keep the Accutome brand growing remain the same: superior customer service, quality, innovation. It is our goal to make every experience you have with us special and productive.

Our focus is to continue to improve our product line and customer service to better suit your needs. We are constantly adding more customer service and sales representatives to provide worldwide support. We also have a European office in the Netherlands.

We have become a total solutions provider for all of your ophthalmic needs by supplying quality products such as office medications, supplies, surgical instruments, and diagnostic equipment. We carry thousands of products to meet your needs. If you do not see a particular item, give our representatives a call, and we will find it for you.

## Accutome Surgical Instruments and Supplies

Accutome offers a full line of diamond and metal surgical blades along with handheld surgical instruments and surgical disposable products. We are one of the top production and repair facilities of diamond knives. We cross-reference and competitively bid on all major brands of ophthalmic instruments - just send us your list for a quote.

Our reputation for innovation has been developed based on our relationships with top surgeons. Do you have an idea for a new instrument? Give us a call to discuss your idea.

## Accutome Repair Center

Our state-of-the-art repair and technical support center is staffed by highly trained technicians. We offer expert repairs on all brands of ophthalmic surgery instruments and ultrasound. We are also experts in diamond knife repair, having one of the largest diamond repair facilities in the U.S. Accutome can customize diamond blades to your specifications and the Diamond Exchange Program allows you to downsize existing blades for a low cost. Most brands and styles can be repaired by us, usually in 24 hours. Our instrument repair unit can sharpen or repair surgical instruments, making them like new.

## Accutome Diagnostic Equipment

Accutome offers a broad line of ophthalmic diagnostic equipment. We started in the 1980s by developing the first ophthalmic pachymeter. Today, we feature a full line of diagnostic equipment including: 4Sight, A-Scan Plus Connect, B-Scan Plus, UBM Plus, PachPen handheld pachymeter, AccuPach VI, and AccuPen handheld tonometer.

As an extension of our great customer service, Accutome also offers in-house diagnostic product specialists. Our specialists are available during work hours, Monday through Friday 8am to 8pm EST.

## Accutome Office Medications and Supplies

Accutome carries thousands of diagnostic pharmaceuticals and clinical exam supplies. There are no minimum order requirements, and most products ship out on the same day. We run quarterly specials on our most popular products, which can be found on our website at [www.accutome.com](http://www.accutome.com).

## ACCUSHARP DISPOSABLE OPHTHALMIC KNIVES

### NON-GUARDED DISPOSABLE OPHTHALMIC KNIVES .....12

|  |    |
|--|----|
| AccuSharp Ophthalmic Angled Slit Knife.....    | 12 |
| AccuSharp Ophthalmic Straight Knife.....       | 13 |
| AccuSharp Ophthalmic Sideport/MVR Knife .....  | 13 |
| AccuSharp Ophthalmic Crescent Knife .....      | 14 |
| AccuSharp Ophthalmic Angled Implant Knife..... | 14 |
| Stab Knife .....                               | 14 |

### GUARDED DISPOSABLE OPHTHALMIC KNIVES.....15

|   |    |
|---|----|
| AccuSharp Guarded Ophthalmic Angled Slit Knife.....   | 15 |
| AccuSharp Guarded Ophthalmic Straight Knife .....     | 15 |
| AccuSharp Guarded Ophthalmic Sideport/MVR Knife ..... | 15 |
| AccuSharp Guarded Ophthalmic Crescent Knife.....      | 16 |
| AccuSharp Guarded Ophthalmic LRI Knife.....           | 16 |

## DIAMOND KNIVES

### PHACO INCISION DIAMOND KNIVES .....19

|   |    |
|---|----|
| Simplicity Series .....                           | 19 |
| Simplicity Trapezoid Series .....                 | 19 |
| Dual Bevel Diamond Knife (Dual Sides Sharp) ..... | 20 |
| Dual Bevel Diamond Knife (Four Sides Sharp) ..... | 21 |
| Dual Bevel Trapezoid Diamond Knife .....          | 21 |

### SPECIALTY DIAMOND KNIVES .....22

|                                       |    |
|---------------------------------------|----|
| Crescent Diamond Knife.....           | 22 |
| Sclerostomy Diamond Knife.....        | 23 |
| Universal Cataract Diamond Knife..... | 23 |

### PARACENTESIS/STAB DIAMOND KNIVES.....23

|                              |    |
|------------------------------|----|
| Hawkeye Series .....         | 23 |
| Hawkeye Premium Series ..... | 24 |

### ASTIGMATISM MANAGEMENT DIAMOND KNIVES.....25

|  |    |
|--|----|
| Donnenfeld Preset LRI, Long Handle.....                | 25 |
| Donnenfeld Preset LRI, Short Handle.....               | 25 |
| Donnenfeld Preset Truncated Lancet, Long Handle .....  | 26 |
| Donnenfeld Preset Truncated Lancet, Short Handle ..... | 26 |
| Chang LRI Diamond Knife.....                           | 27 |
| Rubenstein Preset LRI, Long Handle.....                | 27 |
| Rubenstein Preset Truncated Lancet, Long Handle .....  | 28 |
| Rubenstein Preset LRI, Short Handle .....              | 28 |
| Surgeon's Choice Adjustable .....                      | 29 |
| Micrometer .....                                       | 29 |

## SAPPHIRE KNIVES

### KERATOME SAPPHIRE KNIVES .....32

|                                   |    |
|-----------------------------------|----|
| Clear Cornea Sapphire Knife ..... | 32 |
| Spears Sapphire Knife .....       | 32 |
| Trapezoid Sapphire Knife.....     | 32 |

### CRESCENT SAPPHIRE KNIVES .....33

|                              |    |
|------------------------------|----|
| Crescent Sapphire Knife..... | 33 |
|------------------------------|----|

### SAPPHIRE STAB KNIVES.....33

|                                  |    |
|----------------------------------|----|
| Lancet Sapphire Knife .....      | 33 |
| Single-Edge Sapphire Knife ..... | 33 |
| Trifacet Sapphire Knife .....    | 33 |

## BIPOLAR INSTRUMENTS

### BIPOLAR CABLES & PROBES.....36

|                      |    |
|----------------------|----|
| Bipolar Cables ..... | 36 |
| Cautery Probe.....   | 36 |

### BIPOLAR FORCEPS .....36

|                                 |    |
|---------------------------------|----|
| Adson Bipolar Forceps.....      | 36 |
| Coaptation Bipolar Forceps..... | 37 |
| Jewelers Bipolar Forceps .....  | 37 |
| McPherson Bipolar Forceps.....  | 37 |
| Shepard Bipolar Forceps .....   | 38 |

## CALIPERS, GAUGES & MARKERS

### CALIPERS .....40

|                                |    |
|--------------------------------|----|
| Braunstein Fixed Caliper ..... | 40 |
| Castroviejo Caliper.....       | 40 |
| Jameson Caliper .....          | 40 |
| Stahl Corneal Caliper .....    | 41 |

### GAUGES .....41

|                          |    |
|--------------------------|----|
| Mendez Degree Gauge..... | 41 |
|--------------------------|----|

### MARKERS.....41

|  |    |
|--|----|
| Bores Axis Marker .....                    | 41 |
| Chayet Marker .....                        | 42 |
| Dell LRI Astigmatism Marker.....           | 42 |
| Devgan Axis Marker .....                   | 43 |
| Hoffer Optical Zone Marker.....            | 43 |
| LASIK Corneal Marker.....                  | 44 |
| Osher-Neumann Radial Incision Marker ..... | 44 |
| Plain Optical Zone Marker.....             | 45 |
| Rubenstein LASIK Corneal Marker.....       | 45 |
| Toric Lens Marker.....                     | 45 |
| Toric Reference Marker .....               | 46 |

## CANNULAS & CYSTOTOMES

### ACCUSURGICAL SINGLE-USE CANNULAS & CYSTOTOMES .....48

|                                       |    |
|---------------------------------------|----|
| Atkinson Retrobulbar Needle .....     | 48 |
| Atkinson Peribulbar Needle.....       | 48 |
| Non Atkinson Retrobulbar Needle ..... | 48 |
| Non Atkinson Peribulbar Needle .....  | 49 |
| Sub Tenon Anesthesia Cannula .....    | 49 |
| Rous Sub Tenon/Parabulbar Needle..... | 50 |

|  |    |   |           |
|--|----|---|-----------|
| Anterior Chamber Cannula, Angled .....             | 50 | LASIK Cannula [Slade].....                            | 74        |
| Anterior Chamber Cannula, Straight .....           | 54 | LASIK Cannula [Linn].....                             | 74        |
| Anterior Chamber Cannula, Curved .....             | 54 | Refractive Cannula.....                               | 74        |
| Air Injection Cannula .....                        | 55 | Femtosecond Cannula [Solomon].....                    | 75        |
| Viscoelastic Cannula .....                         | 55 | Brody Femtosecond Dissecting Cannula .....            | 75        |
| Thin Wall Anterior Chamber Cannula, Angled .....   | 55 | AccuDrop Cannula .....                                | 75        |
| Thin Wall Anterior Chamber Cannula, Curved .....   | 56 | <b>REUSABLE CANNULAS &amp; CYSTOTOMES.....</b>        | <b>76</b> |
| Thin Wall Anterior Chamber Cannula, Straight ..... | 56 | Atkinson Retrobulbar Needle .....                     | 76        |
| Double I/A Cannula .....                           | 57 | Air Injection Cannula .....                           | 76        |
| J-Shaped Double I/A Cannula.....                   | 57 | Gills-Welsh Aspirating Cannula .....                  | 77        |
| Double Barrel I/A Cannula [Simcoe] .....           | 57 | McIntyre Anterior Chamber Cannula.....                | 78        |
| Cortex Extractor [Charleux].....                   | 57 | McIntyre-Binkhorst Irrigating Cannula.....            | 79        |
| Cortex Extractor [Simcoe] .....                    | 58 | Bishop-Harmon Irrigating Cannula.....                 | 79        |
| Button Coaxial I/A System .....                    | 58 | Bishop-Harmon Irrigating Cannula Bulb .....           | 80        |
| J-Shaped Cannula .....                             | 58 | Adapter for Irrigators .....                          | 80        |
| J-Shaped Cannula [Binkhorst].....                  | 59 | Bishop-Harmon Irrigating Cannula Set .....            | 81        |
| Micro J-Shaped Cannula [Hessburg] .....            | 59 | Cystotome Cannula .....                               | 81        |
| Irrigating Cystotome.....                          | 60 | Lewicky Cystotome .....                               | 81        |
| Irrigating Double Sharp Cystotome [Kelman] .....   | 63 | Hydrodissection Cannula .....                         | 81        |
| Irrigating Sharp Cystotome [Kelman] .....          | 64 | Akahoshi II Hydrodissection Cannula.....              | 83        |
| Capsule Polisher .....                             | 64 | Chang Nucleus Hydrodissection Cannula.....            | 83        |
| Posterior Capsule Polisher .....                   | 64 | Simcoe Cortex Extractor Cannula .....                 | 84        |
| Silicone Tip Capsule Polisher .....                | 65 | Infusion Cannula .....                                | 84        |
| Irrigating Vectis .....                            | 65 | Anis Cortex Aspirating Cannula.....                   | 84        |
| Bishop-Harmon Washout Cannula .....                | 65 | Graether Collar Button Cannula .....                  | 84        |
| Nucleus Hydrodissection Cannula .....              | 66 | Infusion Handle .....                                 | 85        |
| Hydrodissection Cannula [Chang] .....              | 66 | Henderson MICS Capsule Polisher Cannula.....          | 85        |
| Hydrodissection Cannula [Kellan] .....             | 66 | Jensen Capsule Polisher .....                         | 86        |
| J-Shaped Hydrodissection Cannula.....              | 67 | Gills-Welsh Olive Tip Cannula .....                   | 86        |
| Hydrodelineation Needle [Kellan] .....             | 67 | Lacrimal Cannula .....                                | 86        |
| Nucleus Hydrolysis Needle [P. Koch] .....          | 67 | Bailey Lacrimal Cannula .....                         | 87        |
| Nucleus Hydrodissector/Rotator [Sinsky] .....      | 67 | Fasanella Lacrimal Cannula .....                      | 87        |
| Cotrical Cleaving Hydrodissector .....             | 67 | Simcoe I/A Cannula .....                              | 88        |
| Nucleus Hydrodissector .....                       | 68 | Slade LASIK Cannula .....                             | 88        |
| Lacrimal Cannula .....                             | 68 |   |           |
| Irrigating Dialer .....                            | 68 | <b>CAPSULE POLISHERS</b>                              |           |
| Alpha-Chymotrypsin Cannula.....                    | 68 | <b>NON-IRRIGATING CAPSULE POLISHERS.....</b>          | <b>90</b> |
| Olive Tip Capsule Polisher .....                   | 69 | Accutome Capsule Polishing Sweeper and Curette .....  | 90        |
| Chamber Maintainer .....                           | 69 | Gills-Welsh Capsule Polishing Curette.....            | 90        |
| Chamber Maintainer with Serrated Tip .....         | 70 | Holladay Posterior Capsule Polisher and Curette.....  | 90        |
| Infusion Cannula .....                             | 70 | Nightingale Posterior Capsule Polishing Curette ..... | 90        |
| Membrane Micropick [Eaton].....                    | 70 | Shepherd Capsule Polishing Curette.....               | 90        |
| Retinal Backflush Cannula .....                    | 70 | Singer Sweep Polisher .....                           | 91        |
| Extrusion Cannula.....                             | 71 | Whitman Sheperd Capsule Polisher .....                | 91        |
| Extrusion Cannula with Silicone Tubing .....       | 72 | Accutome 360-Degree Capsule Polishing Curette.....    | 91        |
| High Viscosity Fluid Cannula [Peyman] .....        | 72 |   |           |
| Membrane Dissector [Kingham] .....                 | 72 | <b>CHALAZION INSTRUMENTS</b>                          |           |
| Subretinal Injector [Lambert].....                 | 72 | <b>CURETTES .....</b>                                 | <b>94</b> |
| Subretinal Aspirator [Landers].....                | 72 | Heath Chalazion Ring Curette.....                     | 94        |
| Vitreoretinal Micropick [Glaser] .....             | 73 | Meyerhoeffer Chalazion Curette .....                  | 94        |
| Vitreoretinal Cannula [Vander].....                | 73 |   |           |
| Subretinal Injector [Glaser].....                  | 73 |   |           |
| MVR Cannula [Glaser].....                          | 73 |   |           |
| Subretinal Cannula [Lambert].....                  | 74 |   |           |
| LASIK Cannula [Dishler] .....                      | 74 |   |           |

## LENS MANIPULATORS & CHOPPERS

### LENS MANIPULATORS ..... 96

|  |     |
|--|-----|
| Anis Ball Tip Nucleus Manipulator .....                | 96  |
| Barrett Duo Nucleus Rotator/Manipulator/Splitter ..... | 96  |
| Bechert Lens Pusher .....                              | 96  |
| Bechert Nucleus Rotator .....                          | 96  |
| Clayman Nucleus Rotator .....                          | 96  |
| Drysdale Nucleus Manipulator .....                     | 97  |
| Fenzel Lens Manipulating Hook .....                    | 97  |
| Grayson Nucleus Manipulator .....                      | 97  |
| Grayson/Kuglen Double-Ended Manipulator .....          | 97  |
| Hunkeler IOL Manipulator .....                         | 98  |
| Jaffe-Bechert Nucleus Rotator .....                    | 98  |
| Koch Phacoemulsification Manipulator .....             | 98  |
| Koch Stop and Chop Manipulator .....                   | 98  |
| Lester IOL Manipulator .....                           | 98  |
| Lewicky Lens Manipulator Hook .....                    | 99  |
| Lieberman Microfinger Nucleus Manipulator .....        | 99  |
| Lindstrom STAR Manipulator .....                       | 100 |
| Mackool Double-Ended Chopper and Spatula .....         | 100 |
| Maloney No Hole IOL Manipulator .....                  | 100 |
| Maloney Nucleus Rotator .....                          | 100 |
| Maltsman-Fenzel Lens Manipulating Hook .....           | 100 |
| Hunkeler IOL Manipulator .....                         | 101 |
| Masket Phaco Spatula .....                             | 101 |
| Nordan Capsule Elevator .....                          | 101 |
| O’Gawa Lens Dialer .....                               | 101 |
| Osher “Y” IOL Hook .....                               | 102 |
| Osher Iris Retractor .....                             | 102 |
| Osher Nucleus Manipulator .....                        | 102 |
| Pisacano Nucleus Rotator .....                         | 102 |
| Rentsch Boat Hook Lens Manipulator .....               | 103 |
| Siepser Endocapsular Controller .....                  | 103 |
| Sinsky C-Hook, Modified .....                          | 103 |
| Sinsky Lens Manipulating Hook .....                    | 103 |
| Tennant Nucleus Manipulator .....                      | 104 |

### CHOPPERS ..... 105

|  |     |
|--|-----|
| Accutome Wand .....  | 105 |
| Akahoshi Nucleus Sustainer .....                                   | 105 |
| Ambidextrous Seibel Nucleus Chopper .....                          | 106 |
| Castroviejo Dissector .....  | 106 |
| Chang Microfinger Phaco Chopper and Quick Chopper .....            | 106 |
| Chang-Seibel Microfinger Chopper and Vertical Safety Chopper ..... | 106 |
| Davidoff Ambidextrous Nucleus Chopper .....                        | 106 |
| Dodick-Kammann Nucleus Chopper .....                               | 107 |
| Escaf Nucleus Sustainer .....                                      | 107 |
| Fukasaku Snapper Chopper .....                                     | 107 |
| Goldberg Sideport Splitter .....                                   | 107 |
| Haefliger Phaco Cleaver .....                                      | 107 |
| He Hook Chopper .....  | 108 |
| Keener Lens/Nucleus Divider .....                                  | 108 |
| Koch Spatula and Nagahara Chopper .....                            | 108 |
| Lieberman Microfinger and Spatula .....                            | 108 |

|   |     |
|---|-----|
| Mackool Phaco Chopper .....                             | 108 |
| Mackool Phaco Chopper and Nucleus Chopper .....         | 109 |
| Maloney Quick-Chop .....                                | 109 |
| Nagahara Fine Chopper and Nichamin Quick Chopper .....  | 109 |
| Nagahara Phaco Chopper .....                            | 109 |
| Nichamin Double-Ended Nucleus Chopper and Spatula ..... | 110 |
| Nichamin Quick Chopper .....                            | 110 |
| Nichamin Quick Chopper II .....                         | 110 |
| Nichamin Triple Chopper .....                           | 110 |
| Nucleus Chopper and Safety Quick Chopper .....          | 110 |
| Rosen Chopper .....                                     | 111 |
| Seibel Nucleus Chopper .....                            | 111 |
| Seibel Nucleus Chopper and Safety Quick Chopper .....   | 111 |
| Seibel Safety Quick Chopper .....                       | 111 |
| Steinert II Nucleus Claw Chopper .....                  | 112 |
| Sweeney Manipulator Cracker .....                       | 112 |
| Verges Phaco Chopper .....                              | 112 |

## HOOKS & RETRACTORS

### HOOKS ..... 114

|  |     |
|--|-----|
| Bonn Iris Hook .....                             | 114 |
| Clayman Micro Iris Hook .....                    | 114 |
| Clayman-Jaffe Lens Manipulating Hook .....       | 114 |
| Crawford Retrieving Hook .....                   | 114 |
| Crawford/Benger Probe Retrieving Hook .....      | 114 |
| Culler Rectus Muscle Hook .....                  | 115 |
| Double Fixation Hook .....                       | 115 |
| Fukasaku Snapper Hook .....                      | 115 |
| Gass Retinal Detachment Hook .....               | 115 |
| Graether Collar Button-Handle .....              | 115 |
| Hirschman Iris Hook .....                        | 116 |
| Iris Hook .....                                  | 116 |
| Jaffe Iris Hook .....                            | 116 |
| Jaffe Lens Manipulating Hook .....               | 116 |
| Jaffe-Maltzman Lens Manipulating Hook .....      | 117 |
| Kirby Expressor Double-Ended Hook and Loop ..... | 117 |
| Kuglen Iris Hook Lens Manipulator .....          | 117 |
| Maumenee Iris Hook .....                         | 118 |
| Shepard Iris Hook .....                          | 118 |
| Sinsky Iris and IOL Hook .....                   | 119 |
| Smith Expressor Hook .....                       | 119 |
| Stevens Tenotomy Hook .....                      | 119 |
| Twist Fixation Hook .....                        | 119 |
| Tyrell Iris Hook .....                           | 120 |
| University of Kansas Spatula and Hook .....      | 120 |
| Green Strabismus Hook .....                      | 120 |
| Jameson Muscle Hook .....                        | 120 |
| Von Graefe Strabismus Hook .....                 | 120 |

### RETRACTORS ..... 121

|                                    |     |
|------------------------------------|-----|
| Berke-Jaeger Lid Plate .....       | 121 |
| Conway Lid Retractor .....         | 121 |
| Desmarres Lid Retractor .....      | 121 |
| Knapp Lacrimal Sac Retractor ..... | 122 |



|   |     |
|---|-----|
| Pupil Iris Retractor.....                 | 122 |
| Rizzuti Expressor and Iris Retractor..... | 122 |
| Schepens Orbital Retractor.....           | 122 |

## DSEK INSTRUMENTS

|                                       |            |
|---------------------------------------|------------|
| <b>DSEK .....</b>                     | <b>124</b> |
| Carlson DSEK Smoother.....            | 124        |
| Descemet's DSEK/DSAEK Stripper.....   | 124        |
| Rosenwasser Endothelial Stripper..... | 124        |

## FIXATION RINGS & PICKS

|  |            |
|--|------------|
| <b>FIXATION RINGS.....</b>             | <b>126</b> |
| Fine-Thornton Fixation Ring.....       | 126        |
| Flieringa Scleral Fixation Ring .....  | 126        |
| Globe Fixation Ring.....               | 127        |
| Thornton Fixation Ring .....           | 127        |
| <b>FIXATION PICKS .....</b>            | <b>127</b> |
| Anis Scleral Twist Fixation Cone ..... | 127        |
| Burch Fixation Pick .....              | 128        |

## FORCEPS & CLAMPS

|   |            |
|---|------------|
| <b>CAPSULE FORCEPS.....</b>               | <b>130</b> |
| Arruga Capsule Forceps .....              | 130        |
| Castroviejo Capsule Forceps.....          | 130        |
| Gaskin Fragment Forceps .....             | 130        |
| Kraff Capsule Tag Forceps.....            | 130        |
| <b>CAPSULORHEXIS FORCEPS .....</b>        | <b>131</b> |
| Devgan MICS Capsulorhexis Forceps.....    | 131        |
| Gianetti MICS Capsulorhexis Forceps ..... | 131        |
| Gimbel Capsulorhexis Forceps .....        | 131        |
| Kellan Capsulorhexis Forceps.....         | 131        |
| Lehner-Utrata Capsulorhexis Forceps ..... | 131        |
| Masket Capsulorhexis Forceps .....        | 132        |
| Nevyas Capsulorhexis Forceps.....         | 132        |
| O'Gawa-Utrata Capsulorhexis Forceps ..... | 132        |
| Utrata Capsulorhexis Forceps.....         | 132        |
| Utrata MICS Capsulorhexis Forceps .....   | 134        |
| <b>CHALAZION FORCEPS .....</b>            | <b>134</b> |
| Baird Chalazion Forceps.....              | 134        |
| Desmarres Chalazion Forceps .....         | 134        |
| Francis Chalazion Forceps .....           | 134        |
| Heath Chalazion Forceps.....              | 135        |
| Hunt Chalazion Forceps .....              | 135        |
| Lambert Chalazion Forceps .....           | 135        |
| Wies Chalazion Forceps.....               | 135        |
| <b>CILIA FORCEPS .....</b>                | <b>136</b> |
| Barraquer Cilia Forceps .....             | 136        |
| Cilia Forceps.....                        | 136        |
| Drews Cilia Forceps.....                  | 136        |

|   |            |
|---|------------|
| Gradle Cilia Forceps.....                             | 136        |
| Swiss Cilia and Suture Forceps.....                   | 137        |
| <b>CORNEAL FORCEPS .....</b>                          | <b>137</b> |
| Castroviejo Colibri Corneal Forceps.....              | 137        |
| Girard Corneoscleral Forceps.....                     | 137        |
| Hyde Corneal Forceps.....                             | 138        |
| Katzin-Barraquer Colibri Corneal Utility Forceps..... | 138        |
| Pierse Colibri Corneal Forceps .....                  | 138        |
| Polack Colibri Corneal Forceps .....                  | 138        |
| Thorpe Corneal Forceps.....                           | 138        |
| Troutman-Barraquer Colibri Corneal Forceps .....      | 139        |
| <b>DSEK FORCEPS .....</b>                             | <b>139</b> |
| Charlie II Donor Forceps .....                        | 139        |
| Rossenwasser Donor Lamella Forceps.....               | 139        |
| Snyder Stripping Forceps.....                         | 140        |
| <b>DRESSING FORCEPS.....</b>                          | <b>140</b> |
| Bishop-Harmon Dressing Forceps.....                   | 140        |
| Dressing Forceps .....                                | 140        |
| <b>FEMTOSECOND FORCEPS .....</b>                      | <b>141</b> |
| Femto LRI Enhancement Forceps .....                   | 141        |
| <b>FIXATION FORCEPS .....</b>                         | <b>141</b> |
| Castroviejo Fixation Forceps.....                     | 141        |
| Fechtner Conjunctiva Forceps .....                    | 141        |
| Graefe Fixation Forceps.....                          | 142        |
| Green Fixation Forceps .....                          | 142        |
| Kremer Corneal Fixation Forceps.....                  | 142        |
| Lester Fixation Forceps .....                         | 142        |
| McGregor Conjunctiva Forceps .....                    | 142        |
| Moody Fixation Forceps.....                           | 143        |
| Osher Fixation Forceps.....                           | 143        |
| Thorpe Conjunctiva Forceps.....                       | 143        |
| <b>HEMOSTATIC FORCEPS .....</b>                       | <b>143</b> |
| Hemostatic Forceps.....                               | 143        |
| Kelly Hemostatic Forceps.....                         | 144        |
| Sponge Forceps .....                                  | 144        |
| <b>IOL FORCEPS .....</b>                              | <b>145</b> |
| Accutome Folding Forceps .....                        | 145        |
| Faulkner Lens Holding Forceps.....                    | 145        |
| Haberle-McPherson Lens Holding Forceps.....           | 145        |
| Implant Removal Forceps.....                          | 145        |
| IOL Lens Loading Forceps .....                        | 145        |
| Accutome IOL Lens Loading Forceps .....               | 146        |
| Livernois IOL Folding Forceps .....                   | 146        |
| Livernois IOL Holding Forceps.....                    | 146        |
| Steinert Folding Forceps .....                        | 146        |
| Universal II IOL Insertion Forceps.....               | 147        |
| Universal III IOL Insertion Forceps.....              | 147        |
| <b>JEWELER FORCEPS.....</b>                           | <b>147</b> |
| Jeweler Forceps .....                                 | 147        |
| Suture Removal Forceps.....                           | 148        |

|   |            |   |            |
|---|------------|---|------------|
| Jewler's Type Utility and Splinter Forceps..... | 148        | <b>CLAMPS .....</b>                                 | <b>162</b> |
| <b>LASIK FORCEPS .....</b>                      | <b>149</b> | Clamp.....  | 162        |
| Buratto LASIK Flap Forceps .....                | 149        | <b>I/A &amp; BIMANUAL HANDPIECES</b>                |            |
| <b>MUSCLE FORCEPS .....</b>                     | <b>149</b> | <b>DISPOSABLE I/A INSTRUMENTS.....</b>              | <b>164</b> |
| Berke Ptosis Forceps.....                       | 149        | Bimanual I/A System.....                            | 164        |
| Putterman Muscle Forceps .....                  | 149        | Mono-Manual I/A System.....                         | 164        |
| Troutman Superior Rectus Forceps .....          | 149        | <b>REUSABLE I/A INSTRUMENTS .....</b>               | <b>165</b> |
| <b>PRE-CHOPPER FORCEPS .....</b>                | <b>150</b> | Bimanual Aspirating Unit .....                      | 165        |
| Akahoshi PreChop Forceps .....                  | 150        | Bimanual Aspiration Cannula Tip.....                | 166        |
| D&K Salvitti Akahoshi PreChopping Forceps ..... | 150        | Bimanual Irrigating Unit .....                      | 166        |
| Dodick Nucleus Cracker .....                    | 150        | Bimanual Irrigation Cannula Tip.....                | 167        |
| Ernest Nucleus Cracker.....                     | 150        | Donnenfeld Irrigating Hook .....                    | 167        |
| Salz Nucleus Splitter .....                     | 151        | I/A Handpiece.....                                  | 167        |
| <b>RETINAL FORCEPS .....</b>                    | <b>151</b> | I/A Tip .....                                       | 168        |
| Scleral Plug Forceps .....                      | 151        | <b>KNIFE HANDLES</b>                                |            |
| <b>SUTURING FORCEPS.....</b>                    | <b>151</b> | <b>BARD-PARKER KNIFE HANDLES .....</b>              | <b>172</b> |
| Bonn Suturing Forceps .....                     | 151        | Bard-Parker Knife Handle.....                       | 172        |
| Castroviejo Suturing Forceps.....               | 152        | <b>BEAVER CHUCK KNIFE HANDLES.....</b>              | <b>172</b> |
| Fine-Castroviejo Suturing Forceps.....          | 153        | Beaver Chuck Knife Handle .....                     | 172        |
| Kelman-McPherson Suturing Forceps.....          | 153        | <b>REUSABLE KNIVES</b>                              |            |
| Manhattan Eye and Ear Suturing Forceps.....     | 154        | <b>REUSABLE KNIVES.....</b>                         | <b>174</b> |
| O'Gawa Suture Fixation Forceps .....            | 154        | Gill Corneal Knife.....                             | 174        |
| Paufique Suturing Forceps.....                  | 154        | Martinez Double-Ended Corneal Dissector Knife ..... | 174        |
| Stern-Castroviejo Suturing Forceps.....         | 154        | Tooke Corneal Knife .....                           | 174        |
| <b>TISSUE FORCEPS .....</b>                     | <b>155</b> | <b>LACRIMAL INSTRUMENTS</b>                         |            |
| Adson Tissue Forceps.....                       | 155        | <b>LACRIMAL PROBES .....</b>                        | <b>176</b> |
| Bishop-Harmon Tissue Forceps.....               | 155        | Bowman Lacrimal Probe Set .....                     | 176        |
| Hoskins Tissue Forceps.....                     | 155        | Bowman Lacrimal Probe .....                         | 176        |
| Tissue Forceps .....                            | 156        | Catalano Intubation Probe Set .....                 | 177        |
| <b>TYING FORCEPS .....</b>                      | <b>156</b> | Pigtail Probe .....                                 | 177        |
| Bechert-McPherson Angled Tying Forceps .....    | 156        | Jackson Lacrimal Intubation Set.....                | 177        |
| Castroviejo Tying Forceps.....                  | 156        | <b>LACRIMAL DILATORS.....</b>                       | <b>177</b> |
| Fine Tying Forceps .....                        | 156        | Castroviejo Double-Ended Lacrimal Dilator .....     | 177        |
| Gerl Tying Forceps.....                         | 157        | Hosford Double-Ended Lacrimal Dilator.....          | 178        |
| Girard Fine Tying Forceps .....                 | 157        | Infant Lacrimal Dilator.....                        | 178        |
| Harms-Tuebingen Tying Forceps .....             | 157        | Muldoon Lacrimal Dilator.....                       | 178        |
| Jaffe Tying Forceps.....                        | 157        | Ruedemann Lacrimal Dilator.....                     | 178        |
| Kelman-McPherson Tying Forceps .....            | 158        | Wilder Lacrimal Dilator .....                       | 178        |
| McPherson Tying Forceps.....                    | 158        | <b>LASEK INSTRUMENTS</b>                            |            |
| O'Gawa Tying Forceps.....                       | 159        | <b>LASEK INSTRUMENTS .....</b>                      | <b>180</b> |
| O'Gawa-Castroviejo Tying Forceps .....          | 159        | Camellin LASEK Trephine .....                       | 180        |
| Sheets-McPherson Tying Forceps .....            | 160        | LASEK Alcohol Well .....                            | 180        |
| Tennant Tying Forceps.....                      | 160        |   |            |
| <b>UTILITY FORCEPS .....</b>                    | <b>161</b> |   |            |
| Alabama University Utility Forceps.....         | 161        |   |            |
| Bonaccolto Utility Forceps .....                | 161        |   |            |
| Gill Iris Forceps .....                         | 161        |   |            |
| Kennerdell Bayonet Forceps .....                | 161        |   |            |
| Nugent Utility Forceps.....                     | 161        |   |            |
| Wills Hospital Utility Forceps .....            | 162        |   |            |

|   |            |   |            |
|---|------------|---|------------|
| LASEK Epithelial Trephine .....             | 180        | Schocket Double-Ended Scleral Depressor .....               | 199        |
| <b>LENS LOOPS</b>                           |            | <b>PUNCHES</b>  |            |
| <b>LENS LOOPS .....</b>                     | <b>182</b> | <b>PUNCHES .....</b>  | <b>202</b> |
| Gills-Welsh Lens Loop .....                 | 182        | Kelly Descemet's Membrane Punch.....                        | 202        |
| Kansas Lens Loop.....                       | 182        | <b>RETINAL PICKS</b>  |            |
| Keener-Alt Lens Loop .....                  | 182        | <b>RETINAL PICKS .....</b>                                  | <b>204</b> |
| Kirby Intra-Capsular Lens Loop .....        | 182        | Olk Angled Retinal Pick .....                               | 204        |
| Lewis Lens Loop.....                        | 183        | <b>SCISSORS</b>   |            |
| New Orleans Eye and Ear Lens Loop.....      | 183        | <b>CORNEAL SCISSORS .....</b>                               | <b>206</b> |
| Simcoe Double-Ended Nucleus Loop .....      | 183        | Aebli Corneal Scissors.....                                 | 206        |
| Wilder Lens Loop.....                       | 183        | Aebli Corneal Section Scissors .....                        | 206        |
| <b>NEEDLE HOLDERS</b>                       |            | Manson-Aebli Corneal Scissors .....                         | 207        |
| <b>LOCKING NEEDLE HOLDERS.....</b>          | <b>186</b> | Azar Corneal Scissors.....                                  | 207        |
| Anis Needle Holder, Locking.....            | 186        | Barraquer Corneal Section Scissors.....                     | 207        |
| Barraquer Needle Holder, Locking .....      | 186        | Castroviejo Corneal Scissors .....                          | 207        |
| Castroviejo Needle Holder, Locking .....    | 187        | Castroviejo Corneal Section Scissors .....                  | 208        |
| Jaffe Needle Holder .....                   | 188        | Castroviejo Keratoplasty Scissors.....                      | 209        |
| Kalt Needle Holder .....                    | 188        | Hoffer-Stern Scissors.....                                  | 209        |
| McPherson Needle Holder .....               | 189        | Katzin Corneal Transplant Scissors.....                     | 210        |
| Needle Holder, Locking .....                | 189        | Troutman-Castroviejo Corneal Section Scissors.....          | 210        |
| Troutman Needle Holder .....                | 189        | Troutman-Katzin Corneal Transplant Scissors .....           | 210        |
| <b>NON-LOCKING NEEDLE HOLDERS .....</b>     | <b>190</b> | <b>ENUCLEATION SCISSORS.....</b>                            | <b>210</b> |
| Anis Needle Holder, Non-Locking .....       | 190        | Enucleation Scissors .....                                  | 210        |
| Barraquer Needle Holder, Non-Locking .....  | 190        | <b>EYE SCISSORS.....</b>                                    | <b>211</b> |
| Castroviejo Needle Holder, Non-Locking..... | 191        | Eye Scissors .....  | 211        |
| Cohan Needle Holder .....                   | 191        | <b>INTRAOCULAR SCISSORS .....</b>                           | <b>212</b> |
| McPherson Needle Holder .....               | 192        | Intraocular Scissors.....                                   | 212        |
| Needle Holder, Non-Locking.....             | 192        | <b>IOL REMOVAL SCISSORS .....</b>                           | <b>213</b> |
| O'Gawa Needle Holder .....                  | 192        | Accutome IOL Cutter.....                                    | 213        |
| Osher Needle Holder.....                    | 193        | <b>IRIS SCISSORS .....</b>                                  | <b>213</b> |
| Troutman Needle Holder .....                | 193        | Barraquer Iris Scissors .....                               | 213        |
| <b>OFFICE INSTRUMENTS</b>                   |            | Cohan-Vannas Curved Iris Scissors .....                     | 213        |
| <b>OPHTHALMIC BURRS .....</b>               | <b>196</b> | DeWecker Iris Scissors .....                                | 214        |
| Aaron Burr 2.....                           | 196        | Iris Scissors.....  | 214        |
| Aaron Burr 2 Accessories .....              | 196        | McPherson-Vannas Iris Scissors.....                         | 215        |
| Algerbrush II.....                          | 196        | <b>MISCELLANEOUS SCISSORS.....</b>                          | <b>216</b> |
| Algerbrush II Accessories .....             | 196        | Mayo Dissecting Scissors .....                              | 216        |
| <b>FOREIGN BODY INSTRUMENTS .....</b>       | <b>197</b> | Troutman Conjunctival Scissors .....                        | 216        |
| Ellis Foreign Body Spud.....                | 197        | Westcott Conjunctival Scissors .....                        | 216        |
| Foreign Body Curette .....                  | 198        | <b>STITCH SCISSORS .....</b>                                | <b>216</b> |
| Foreign Body Spud .....                     | 198        | Castroviejo Mini Keratoplasty-Utility-Stitch Scissors ..... | 216        |
| Francis Spud .....                          | 198        | Fine Stitch Scissors.....                                   | 217        |
| Golf Club Spud.....                         | 198        | Jaffe Stitch Scissors .....                                 | 217        |
| <b>SCLERAL DEPRESSORS .....</b>             | <b>199</b> | McPherson-Westcott Stitch Scissors .....                    | 217        |
| Flynn Scleral Depressor.....                | 199        |   |            |
| Schepens Scleral Depressor .....            | 199        |   |            |



|   |            |   |            |
|---|------------|---|------------|
| Stitch Scissors.....                                | 217        | <b>PHACO SPATULAS.....</b>                                  | <b>234</b> |
| Westcott Type Stitch Scissors .....                 | 218        | Gimbel Nucleus Spatula .....                                | 234        |
| <b>STRABISMUS SCISSORS .....</b>                    | <b>218</b> | Jaffe Lens Spatula.....                                     | 234        |
| Knapp Strabismus Scissors.....                      | 218        | Johnson Spatula.....  | 234        |
| Strabismus Scissors .....                           | 219        | Knolle Lens Nucleus Spatula and Anterior Chamber Gauge..... | 234        |
| <b>SUTURE SCISSORS .....</b>                        | <b>219</b> | Knolle Nucleus Spatula .....                                | 235        |
| Littler Suture/Dissecting Scissors.....             | 219        | Koch Nucleus Spatula .....                                  | 235        |
| Stitch Removal Scissors .....                       | 220        | Koch Phacoemulsification Spatula.....                       | 235        |
| <b>TENOTOMY SCISSORS .....</b>                      | <b>220</b> | Lieppman Nucleus Spatula .....                              | 235        |
| McPherson-Westcott Tenotomy Scissors .....          | 220        | Rowen Phaco Spatula .....                                   | 235        |
| Shepard-Westcott Tenotomy Scissors .....            | 220        | <b>REFRACTIVE SPATULAS .....</b>                            | <b>236</b> |
| Stevens Tenotomy Scissors .....                     | 221        | Kimura Platinum Spatula.....                                | 236        |
| Westcott Tenotomy Scissors.....                     | 223        | Maloney PRK Spatula.....                                    | 236        |
| <b>UTILITY SCISSORS.....</b>                        | <b>223</b> | Paton Spatula and Spoon.....                                | 236        |
| Lister Bandage Scissors .....                       | 223        | <b>RETINAL SPATULAS .....</b>                               | <b>236</b> |
| Operating Scissors .....                            | 224        | Maumenee-Barraquer Vitreous Sweep Spatula.....              | 236        |
| Utility Scissors.....                               | 224        | <b>SPECULUMS</b>  |            |
| Westcott Type Utility Scissors .....                | 225        | <b>ADJUSTABLE SPECULUMS.....</b>                            | <b>238</b> |
| <b>VANNAS SCISSORS.....</b>                         | <b>225</b> | Cook Eye Speculum .....                                     | 238        |
| Gills-Vannas Capsulotomy Scissors .....             | 225        | Kammann Eye Speculum.....                                   | 238        |
| Gills-Welsh-Vannas Micro Scissors.....              | 226        | Lancaster Eye Speculum.....                                 | 238        |
| Stern-Gills Scissors.....                           | 226        | Lester-Burch Eye Speculum .....                             | 238        |
| Uribe-Stern Scissors .....                          | 226        | Lieberman Adjustable Speculum.....                          | 239        |
| Uthoff-Gills Capsulotomy Scissors .....             | 226        | Schott Eye Speculum.....                                    | 240        |
| Vannas Capsulotomy Scissors .....                   | 227        | Williams Eye Speculum.....                                  | 240        |
| Vannas Scissors .....                               | 227        | <b>ASPIRATING SPECULUMS .....</b>                           | <b>241</b> |
| <b>SPATULAS</b>                                     |            | Lieberman Aspirating Speculum .....                         | 241        |
| <b>CYCLODIALYSIS SPATULAS.....</b>                  | <b>230</b> | Machat LASIK Speculum .....                                 | 241        |
| Barraquer Cyclodialysis Spatula.....                | 230        | <b>WIRE SPECULUMS.....</b>                                  | <b>241</b> |
| Castroviejo Cyclodialysis Spatula.....              | 230        | Varley LASIK/Femtosecond Lid Speculum.....                  | 241        |
| Castroviejo Synechia Spatula .....                  | 230        | Alfonso Eye Speculum .....                                  | 242        |
| Wheeler/Elschnig Cyclodialysis Spatula.....         | 231        | Barraquer Lid Speculum.....                                 | 242        |
| <b>DSEK SPATULAS .....</b>                          | <b>231</b> | Floyd-Barraquer Eye Speculum .....                          | 246        |
| Cindy Sweeper DSEK Spatula.....                     | 231        | Kratz-Barraquer Eye Speculum.....                           | 246        |
| <b>FEMTOSECOND SPATULAS.....</b>                    | <b>231</b> | Kratz-Nichamin Lid Speculum .....                           | 246        |
| Eippert Femtosecond Spatula.....                    | 231        | Lehner Lid Speculum .....                                   | 247        |
| Lane Femtosecond Incisional Spatula .....           | 232        | Sauer Eye Speculum .....                                    | 247        |
| Lee Femtosecond Spatula.....                        | 232        | Slade Refractive Speculum .....                             | 247        |
| Slade Femtosecond Laser Spatula .....               | 232        | Temporal Approach Wire Speculum .....                       | 248        |
| Suarez Spreader.....                                | 232        | <b>SPOONS</b>   |            |
| <b>IRIS SPATULAS.....</b>                           | <b>233</b> | <b>EVISCERATION &amp; ENUCLEATION SPOONS.....</b>           | <b>250</b> |
| Barraquer Iris Spatula.....                         | 233        | Bunge Evisceration Spoon .....                              | 250        |
| Culler Iris Spatula .....                           | 233        | Wells Enucleation Spoon .....                               | 250        |
| Iris Spatula .....                                  | 233        | <b>LENS SPOONS .....</b>                                    | <b>250</b> |
| <b>LASIK SPATULAS .....</b>                         | <b>233</b> | Culler Lens Spoon.....                                      | 250        |
| Intralase Flap Lifter and Retreatment Spatula ..... | 233        |   |            |
| Katzen LASIK Flap “Unzipper” .....                  | 234        |   |            |

**STERILIZATION TRAYS**

|   |            |
|---|------------|
| <b>METAL TRAYS</b> .....                                  | <b>252</b> |
| Metal Microsurgical Instrument Sterilization Tray .....   | 252        |
| <b>PLASTIC TRAYS</b> .....                                | <b>253</b> |
| Diamond Knife Tray .....                                  | 253        |
| Plastic Microsurgical Instrument Sterilization Tray ..... | 253        |
| Plastic Phaco Instrument Sterilization Tray .....         | 254        |
| Sterilization Tray Replacement Mat .....                  | 254        |

**TREPHINES & PUNCHES**

|   |            |
|---|------------|
| <b>DISPOSABLE TREPHINES &amp; PUNCHES</b> ..... | <b>256</b> |
| Disposable Radial Vacuum Trepine .....          | 256        |
| Vacuum Donor Punch .....                        | 256        |
| <b>REUSABLE TREPHINES &amp; PUNCHES</b> .....   | <b>257</b> |
| Long Reusable Trepine Blade .....               | 257        |
| Universal Trepine Blade Holder .....            | 259        |

**SUTURES**

|                                      |            |
|--------------------------------------|------------|
| <b>NYLON</b> .....                   | <b>262</b> |
| Sutures 11-0 Nylon .....             | 262        |
| Sutures 10-0 Nylon .....             | 263        |
| Sutures 9-0 Nylon .....              | 265        |
| Sutures 8-0 Nylon .....              | 266        |
| Sutures 7-0 Nylon .....              | 267        |
| Sutures 6-0 Nylon .....              | 269        |
| Sutures 5-0 Nylon .....              | 270        |
| <b>POLYESTER</b> .....               | <b>271</b> |
| Sutures 10-0 Polyester .....         | 271        |
| Sutures 5-0 Polyester .....          | 272        |
| Sutures 4-0 Polyester .....          | 273        |
| <b>POLYGLYCOLIC ACID</b> .....       | <b>274</b> |
| Sutures 10-0 Polyglycolic Acid ..... | 274        |
| Sutures 9-0 Polyglycolic Acid .....  | 275        |
| Sutures 8-0 Polyglycolic Acid .....  | 275        |
| Sutures 7-0 Polyglycolic Acid .....  | 276        |
| Sutures 6-0 Polyglycolic Acid .....  | 276        |
| Sutures 5-0 Polyglycolic Acid .....  | 277        |
| <b>POLYPROPYLENE</b> .....           | <b>278</b> |
| Sutures 6-0 Polypropylene .....      | 278        |
| <b>SILK</b> .....                    | <b>278</b> |
| Sutures 8-0 Silk .....               | 278        |
| Sutures 7-0 Silk .....               | 279        |
| Sutures 6-0 Silk .....               | 280        |
| Sutures 5-0 Silk .....               | 281        |
| Sutures 4-0 Silk .....               | 282        |

**SURGICAL DISPOSABLES**

|   |            |
|---|------------|
| <b>APPAREL</b> .....                              | <b>286</b> |
| Exam Gown .....                                   | 286        |
| Isolation and Fluid-Resistant Surgical Gown ..... | 286        |
| Non-Skid Shoe Cover .....                         | 287        |
| Smooth Bottom Shoe Cover .....                    | 289        |
| McKesson Bouffant Cap .....                       | 289        |
| Pro Series Bouffant Cap .....                     | 289        |
| Single-Ply Bouffant Cap .....                     | 290        |
| Surgeon Cap .....                                 | 291        |
| Surgical Gown .....                               | 292        |
| <b>CAUTERIES</b> .....                            | <b>293</b> |
| Change-a-Tip Cautery .....                        | 293        |
| High-Temperature Cautery .....                    | 294        |
| Low-Temperature Cautery .....                     | 294        |
| Eye Bubble .....                                  | 295        |
| <b>SCALPELS &amp; BLADES</b> .....                | <b>295</b> |
| BD Bard-Parker Scalpel Blade .....                | 295        |
| Beaver Mini-Blade .....                           | 296        |
| Change-a-Blade Safety Scalpel Handle .....        | 296        |
| Cincinnati Lance Blade .....                      | 296        |
| Cincinnati Surgical Blade Remover .....           | 297        |
| Cincinnati Surgical Blade .....                   | 297        |
| Miltex General-Purpose Blade .....                | 298        |
| Miniature Surgical Blade .....                    | 298        |
| Size 10 Disposable Scalpel .....                  | 299        |
| Size 11 Disposable Scalpel .....                  | 299        |
| Size 11 Safety Disposable Scalpel .....           | 300        |
| Size 15 Disposable Scalpel .....                  | 300        |
| Size 15 Safety Disposable Scalpel .....           | 301        |
| Size 21 Disposable Scalpel .....                  | 301        |
| Surgistar Handle and Blade .....                  | 302        |
| <b>DRAPES</b> .....                               | <b>302</b> |
| Adhesive Towel Drape .....                        | 302        |
| Aperture Drape .....                              | 303        |
| Aperture Pouch Drape .....                        | 304        |
| Convertors Mayo Stand Cover .....                 | 304        |
| Convertors Refractive Drape .....                 | 304        |
| Drape Cover .....                                 | 305        |
| General-Purpose Drape .....                       | 305        |
| Incise Drape .....                                | 307        |
| Incise Drape with Pouch .....                     | 308        |
| Instrument Cover .....                            | 309        |
| Medi-Pak Performance Drape .....                  | 309        |
| Poly U Drape .....                                | 309        |
| Split Sheet Drape .....                           | 310        |
| Towel Drape .....                                 | 310        |
| <b>EYE SHIELDS</b> .....                          | <b>311</b> |
| Blue Eye Shield .....                             | 311        |
| Clear Eye Shield .....                            | 311        |
| Gray Eye Shield .....                             | 313        |

|  |            |
|--|------------|
| Metal Eye Shield.....                                  | 313        |
| <b>IRIS RETRACTORS.....</b>                            | <b>313</b> |
| Disposable Iris Retractor.....                         | 313        |
| Reusable Iris Retractor.....                           | 314        |
| <b>LIQUID BANDAGES.....</b>                            | <b>314</b> |
| Histoacryl Topical Skin Adhesive.....                  | 314        |
| <b>PVA PRODUCTS/WECK-CEL.....</b>                      | <b>315</b> |
| Corneal Light Shield.....                              | 315        |
| Cellulose Eye Spear.....                               | 315        |
| PVA Eye Spear.....                                     | 315        |
| LASIK PVA Disk.....                                    | 316        |
| Ultracell Instrument Wipe.....                         | 316        |
| <b>SURGICAL GLOVES.....</b>                            | <b>317</b> |
| Derma Prene Ultra Surgical Gloves.....                 | 317        |
| Encore Acclaim Surgical Gloves.....                    | 317        |
| Encore Surgical Gloves.....                            | 318        |
| No Powder Surgical Gloves.....                         | 318        |
| Perry Performance Plus Micro-Thin Surgical Gloves..... | 318        |
| Perry Performance Plus Surgical Gloves.....            | 319        |
| Sempermed Supreme Surgical Gloves.....                 | 323        |
| SensiCare Surgical Gloves.....                         | 323        |
| Sensi-Touch Surgical Gloves.....                       | 324        |
| Original Perry Style 42 Surgical Gloves.....           | 324        |
| Triflex Surgical Gloves.....                           | 325        |
| Triumph Green Surgical Gloves.....                     | 325        |
| Triumph LT Surgical Gloves.....                        | 325        |
| <b>SURGICAL LENSES.....</b>                            | <b>326</b> |
| Bi-Concave Disposable Lens.....                        | 326        |
| Flat Disposable Lens.....                              | 326        |
| Flat SSV Disposable Lens.....                          | 326        |
| Magnifying Disposable Lens.....                        | 327        |
| Wide Field Disposable Lens.....                        | 327        |
| 30-Degree Prism Disposable Lens.....                   | 327        |
| 30-Degree Prism SSV ACS Lens.....                      | 328        |

## INSTRUMENT COVERS

|                                     |            |
|-------------------------------------|------------|
| <b>PROTECTORS &amp; GUARDS.....</b> | <b>330</b> |
| Comply Instrument Protector.....    | 330        |
| Osteotome Instrument Tip Guard..... | 330        |
| Round Instrument Tip Guard.....     | 330        |
| Standard Instrument Tip Guard.....  | 331        |

## CLEANING & STERILIZING

|  |            |
|--|------------|
| <b>DIAMOND KNIFE CLEANING SYSTEMS.....</b>     | <b>334</b> |
| Opti-Kleen.....                                | 334        |
| <b>INDICATOR STRIPS.....</b>                   | <b>334</b> |
| Biological Indicator Incubator.....            | 334        |
| Biological Indicator Test Pack.....            | 335        |
| Biological Indicator Vial.....                 | 335        |
| Class 4 Steam Indicator Strip.....             | 337        |
| Class 5 Steam Indicator Strip.....             | 338        |
| Dry Heat Sterilization Indicator Strip.....    | 338        |
| Indicator Label.....                           | 338        |
| OK Steam Sterilization Strip.....              | 339        |
| Steam Indicator Tape.....                      | 339        |
| <b>STERILIZATION POUCHES.....</b>              | <b>340</b> |
| Dry-Heat Sterilization Pouch.....              | 340        |
| Steam Sterilization Pouch.....                 | 340        |
| <b>ULTRASONIC CLEANERS.....</b>                | <b>343</b> |
| Crest 0.75-Gallon Ultrasonic Cleaner.....      | 343        |
| Crest 2.5-Gallon Ultrasonic Cleaner.....       | 343        |
| Crest 5-Gallon Ultrasonic Cleaner.....         | 343        |
| <b>QUICKRINSE INSTRUMENT RINSE SYSTEM.....</b> | <b>344</b> |
| QuickRinse Cleaning System.....                | 344        |
| <b>CRYO UNITS</b>                              |            |
| <b>CRYO UNITS.....</b>                         | <b>346</b> |
| Keeler Cryomatic Cryo Unit.....                | 346        |

## PRODUCT NUMBER LOOKUP

# AccuSharp Disposable Ophthalmic Knives

NON-GUARDED DISPOSABLE OPHTHALMIC KNIVES

| Item #  | Description  | Image |
|---|--|-------|
| <b>AccuSharp Ophthalmic Angled Slit Knife</b>   |  |       |
| Disposable, single-use metal blades, ophthalmic angled slit knives with red handles. Comes with bevel up or double bevel options with a 45 degree angled tip. Packaged individually, sterile. Sold 6 per box. |  |       |
| AB-ASLI0  | <b>1.0mm Angled Slit Knife</b><br>1.0mm wide tip, blade is bevel up.       |       |
| AB-ASLI2  | <b>1.2mm Angled Slit Knife</b><br>1.2mm wide tip, blade is bevel up.       |       |
| AB-ASLI8  | <b>1.8mm Angled Slit Knife</b><br>1.8mm wide tip, blade is bevel up.       |       |
| AB-ASLI8DB  | <b>1.8mm Angled Slit Knife</b><br>1.8mm wide tip, blade is double bevel.   |       |
| AB-ASL20  | <b>2.0mm Angled Slit Knife</b><br>2.0mm wide tip, blade is bevel up.       |       |
| AB-ASL22  | <b>2.2mm Angled Slit Knife</b><br>2.2mm wide tip, blade is bevel up.       |       |
| AB-ASL22DB  | <b>2.2mm Angled Slit Knife</b><br>2.2mm wide tip, blade is double bevel.   |       |
| AB-ASL23  | <b>2.3mm Angled Slit Knife</b><br>2.3mm wide tip, blade is bevel up.       |       |
| AB-ASL24  | <b>2.4mm Angled Slit Knife</b><br>2.4mm wide tip, blade is bevel up.       |       |
| AB-ASL24DB  | <b>2.4mm Angled Slit Knife</b><br>2.4mm wide tip, blade is double bevel.   |       |
| AB-ASL25  | <b>2.5mm Angled Slit Knife</b><br>2.5mm wide tip, blade is bevel up.       |       |
| AB-ASL25DB  | <b>2.5mm Angled Slit Knife</b><br>2.5mm wide tip, blade is double bevel.   |       |
| AB-ASL26  | <b>2.65mm Angled Slit Knife</b><br>2.65mm wide tip, blade is bevel up.     |       |
| AB-ASL26DB  | <b>2.65mm Angled Slit Knife</b><br>2.65mm wide tip, blade is double bevel. |       |
| AB-ASL27  | <b>2.75mm Angled Slit Knife</b><br>2.75mm wide tip, blade is bevel up.     |       |
| AB-ASL27DB  | <b>2.75mm Angled Slit Knife</b><br>2.75mm wide tip, blade is double bevel. |       |
| AB-ASL28  | <b>2.8mm Angled Slit Knife</b><br>2.8mm wide tip, blade is bevel up.       |       |
| AB-ASL28DB  | <b>2.8mm Angled Slit Knife</b><br>2.8mm wide tip, blade is double bevel.   |       |
| AB-ASL285   | <b>2.85mm Angled Slit Knife</b><br>2.85mm wide tip, blade is bevel up.     |       |



**NON-GUARDED DISPOSABLE OPHTHALMIC KNIVES**

| Item #     | Description  | Image |
|------------|--|-------|
| AB-ASL30   | <b>3.0mm Angled Slit Knife</b><br>3.0mm wide tip, blade is bevel up.     |       |
| AB-ASL30DB | <b>3.0mm Angled Slit Knife</b><br>3.0mm wide tip, blade is double bevel. |       |
| AB-ASL32   | <b>3.2mm Angled Slit Knife</b><br>3.2mm wide tip, blade is bevel up.     |       |
| AB-ASL32DB | <b>3.2mm Angled Slit Knife</b><br>3.2mm wide tip, blade is double bevel. |       |
| AB-ASL35   | <b>3.5mm Angled Slit Knife</b><br>3.5mm wide tip, blade is bevel up.     |       |

**AccuSharp Ophthalmic Straight Knife**

Disposable, single-use metal blades, ophthalmic straight knives with pink handles. Blades are available in various degrees but all blades are double bevel. Packaged individually, sterile. Sold 6 per box.

|          |  |
|----------|--|
| AB-AST15 | <b>15-Degree Straight Knife</b><br>15-degree angled blade.     |
| AB-AST22 | <b>22.5-Degree Straight Knife</b><br>22.5-degree angled blade. |
| AB-AST30 | <b>30-Degree Straight Knife</b><br>30-degree angled blade.     |
| AB-AST45 | <b>45-Degree Straight Knife</b><br>45-degree angled blade.     |

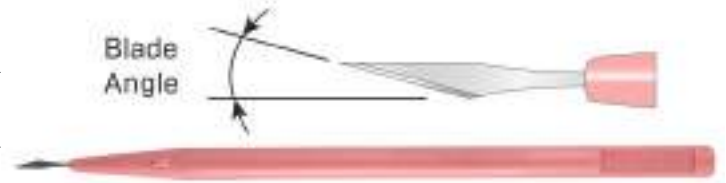

**AccuSharp Ophthalmic Sideport/MVR Knife**

Disposable, single-use metal blades, ophthalmic Sideport/MVR knives with green handles. Blades are available in various sizes and gauges with angled or straight shafts. Packaged individually, sterile. Sold 6 per box.

|           |  |
|-----------|--|
| AB-AVR10  | <b>1.0mm Angled Sideport</b><br>1.0mm wide sideport blade with angled shaft.     |
| AB-AVR10S | <b>1.0mm Straight Sideport</b><br>1.0mm wide sideport blade with straight shaft. |
| AB-AVR12  | <b>1.2mm Angled Sideport</b><br>1.2mm wide sideport blade with angled shaft.     |
| AB-AVR19  | <b>19 Gauge MVR Lance</b><br>19 gauge MVR blade with straight shaft.             |
| AB-AVR19A | <b>19 Gauge MVR Lance</b><br>19 gauge MVR blade with angled shaft.               |
| AB-AVR20  | <b>20 Gauge MVR Lance</b><br>20 gauge MVR blade with straight shaft.             |
| AB-AVR20A | <b>20 Gauge MVR Lance</b><br>20 gauge MVR blade with angled shaft.               |
| AB-AVR23A | <b>23 Gauge MVR Lance</b><br>23 gauge MVR blade with angled shaft.               |
| AB-AVR25  | <b>25 Gauge MVR Lance</b><br>25 gauge MVR blade with straight shaft.             |



NON-GUARDED DISPOSABLE OPHTHALMIC KNIVES

| Item # | Description | Image |
|--------|-------------|-------|
|--------|-------------|-------|

**AccuSharp Ophthalmic Crescent Knife**

Disposable, single-use metal blades, ophthalmic crescent knives with yellow handles. Crescent blades are rounded and measure 2.0mm in width. Blades are available with the bevel up or down and straight or angled. Packaged individually, sterile. Sold 6 per box.

|          |  |
|----------|--|
| AB-ACD26 | <b>Angled Crescent Knife</b><br>Blade is bevel down with 45-degree angled tip. |
| AB-ACS20 | <b>Straight Crescent Knife</b><br>Blade is bevel up with straight tip.         |
| AB-ACU26 | <b>Angled Crescent Knife</b><br>Blade is bevel up with 45-degree angled tip.   |



**AccuSharp Ophthalmic Angled Implant Knife**

Disposable, single-use metal blades, ophthalmic angled implant knives with blue handles. Blades are available in various widths and are bevel up with 45-degree angled tips. Packaged individually, sterile. Comes in a box of 6.

|          |   |
|----------|---|
| AB-ARS32 | <b>3.2mm R Slit Knife</b><br>3.2mm width blade. |
| AB-ARS35 | <b>3.5mm R Slit Knife</b><br>3.5mm width blade. |
| AB-ARS41 | <b>4.1mm R Slit Knife</b><br>4.1mm width blade. |
| AB-ARS52 | <b>5.2mm R Slit Knife</b><br>5.2mm width blade. |



**Stab Knife**

Beaver-Visitec and Sharpoint brand disposable stab knife tips that screw into handles, handles not included. Blue in color with 15-degree angled tips. Sold 6 per box.

|          |   |
|----------|---|
| AXI4112  | <b>Beaver-Visitec Micro-Sharp Blade</b><br>Disposable 3.0mm restricted blade depth.   |
| AX721502 | <b>Sharpoint Stab Knife</b><br>Sharpoint stab knives are heat-tempered to provide a strong, true point for easy penetration during initial stab incisions. Straight blade.                        |
| AX721532 | <b>Sharpoint Stab Knife</b><br>Sharpoint stab knives are heat-tempered to provide a strong, true point for easy penetration during initial stab incisions. 3.0mm straight restricted blade depth. |

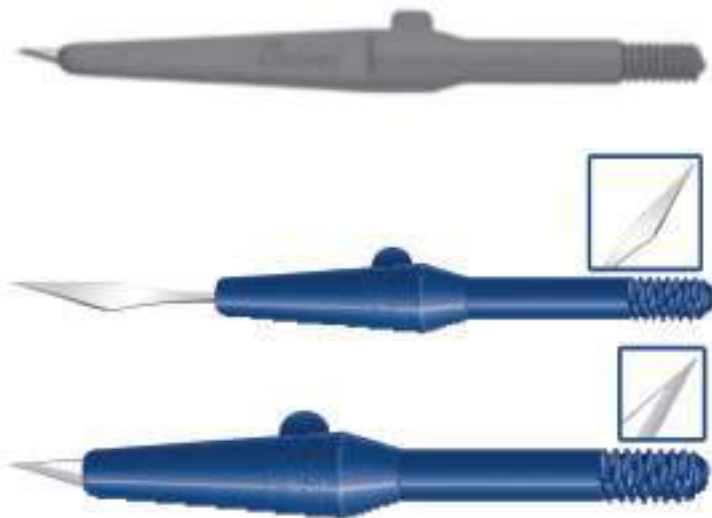

**GUARDED DISPOSABLE OPHTHALMIC KNIVES**

| Item # | Description | Image |
|--------|-------------|-------|
|--------|-------------|-------|

**AccuSharp Guarded Ophthalmic Angled Slit Knife**

Disposable, single-use metal blades, ophthalmic angled slit knives with blue handles. Handle has smooth, single handed blade retraction and has ergonomic design. Blades have superior sharpness and are available in various widths and bevel designs with 45-degree angled tips. Packaged individually, sterile. Sold 6 per box.

|             |  |
|-------------|--|
| AB-ASL22G   | <b>2.2mm Guarded Angled Slit Knife</b><br>2.2mm blade width, bevel up.     |
| AB-ASL24G   | <b>2.4mm Guarded Angled Slit Knife</b><br>2.4mm blade width, bevel up.     |
| AB-ASL24DBG | <b>2.4mm Guarded Angled Slit Knife</b><br>2.4mm blade width, double bevel. |
| AB-ASL25G   | <b>2.5mm Guarded Angled Slit Knife</b><br>2.5mm blade width, bevel up.     |
| AB-ASL26G   | <b>2.65mm Guarded Angled Slit Knife</b><br>2.65mm blade width, bevel up.   |
| AB-ASL27G   | <b>2.75mm Guarded Angled Slit Knife</b><br>2.75mm blade width, bevel up.   |
| AB-ASL28G   | <b>2.8mm Guarded Angled Slit Knife</b><br>2.8mm blade width, bevel up.     |
| AB-ASL30G   | <b>3.0mm Guarded Angled Slit Knife</b><br>3.0mm blade width, bevel up.     |
| AB-ASL32G   | <b>3.2mm Guarded Angled Slit Knife</b><br>3.2mm blade width, bevel up.     |



**AccuSharp Guarded Ophthalmic Straight Knife**

Disposable, single-use metal blades, ophthalmic straight knives with blue handles. Handle has smooth, single handed blade retraction and has ergonomic design. Blades have superior sharpness and are available in various angles and are double bevel. Packaged individually, sterile. Sold 6 per box.

|           |  |
|-----------|--|
| AB-AST15G | <b>15-Degree Guarded Straight Knife</b><br>15-degree angled blade, double bevel.     |
| AB-AST22G | <b>22.5-Degree Guarded Straight Knife</b><br>22.5-degree angled blade, double bevel. |

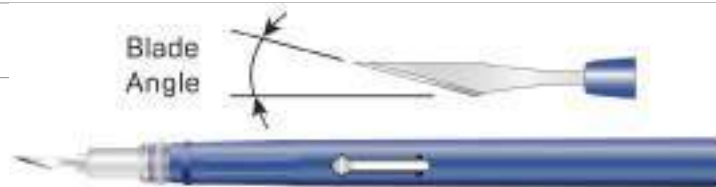

**AccuSharp Guarded Ophthalmic Sideport/MVR Knife**

Disposable, single-use metal blades, ophthalmic Sideport and MVR knives with blue handles. Handle has smooth, single handed blade retraction and has ergonomic design. Blades have superior sharpness and are available in various sizes and are straight or angled. Packaged individually, sterile. Sold 6 per box.

|            |  |
|------------|--|
| AB-AVR10AG | <b>1.0mm Guarded Angled Sideport</b><br>1.0mm wide sideport blade with angled shaft. |
| AB-AVR19G  | <b>19 Gauge Guarded MVR Lance</b><br>19 gauge MVR blade with straight shaft.         |
| AB-AVR19AG | <b>19 Gauge Guarded MVR Lance</b><br>19 gauge MVR blade with angled shaft.           |
| AB-AVR20G  | <b>20 Gauge Guarded MVR Lance</b><br>20 gauge MVR blade with straight shaft.         |



**GUARDED DISPOSABLE OPHTHALMIC KNIVES**

| Item #     | Description  | Image |
|------------|--|-------|
| AB-AVR20AG | <b>20 Gauge Guarded MVR Lance</b><br>20 gauge MVR blade with angled shaft.   |       |
| AB-AVR21G  | <b>21 Gauge Guarded MVR Lance</b><br>21 gauge MVR blade with straight shaft. |       |
| AB-AVR21AG | <b>21 Gauge Guarded MVR Lance</b><br>21 gauge MVR blade with angled shaft.   |       |
| AB-AVR23G  | <b>23 Gauge Guarded MVR Lance</b><br>23 gauge MVR blade with straight shaft. |       |
| AB-AVR23AG | <b>23 Gauge Guarded MVR Lance</b><br>23 gauge MVR blade with angled shaft.   |       |
| AB-AVR25G  | <b>25 Gauge Guarded MVR Lance</b><br>25 gauge MVR blade with straight shaft. |       |
| AB-AVR25AG | <b>25 Gauge Guarded MVR Lance</b><br>25 gauge MVR blade with angled shaft.   |       |

**AccuSharp Guarded Ophthalmic Crescent Knife**

Disposable single-use metal blades, crescent knife, 2.0mm, bevel up, 45-degree angled tip. Blue handle with smooth, single handed blade retraction. Packaged individually, sterile. Sold 6 per box.

|           |                                     |   |
|-----------|-------------------------------------|---|
| AB-ACU26G | <b>2.0mm Guarded Crescent Knife</b> |  |
|-----------|-------------------------------------|---|

**AccuSharp Guarded Ophthalmic LRI Knife**

Disposable, single-use metal blades, ophthalmic LRI knives with blue handles. Handle has smooth, single handed blade retraction and has ergonomic design. Blades have superior sharpness and are available in various preset incision depths with a 1.0mm blade width. Packaged individually, sterile. Sold 6 per box.

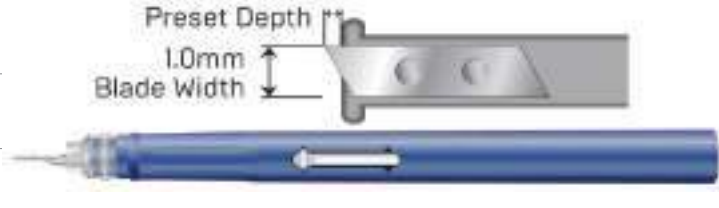
|             |  |  |
|-------------|--|--|
| AB-ALRI500G | <b>500 Micron Guarded LRI Knife</b><br>500 micron preset incision depth. |  |
| AB-ALRI550G | <b>550 Micron Guarded LRI Knife</b><br>550 micron preset incision depth. |  |
| AB-ALRI600G | <b>600 Micron Guarded LRI Knife</b><br>600 micron preset incision depth. |  |

# Diamond Knives





# On the Cutting Edge

Accutome's diamond knives are the perfect blend of design and craftsmanship, in order to make superior corneal incisions. With an in-house repair facility, Accutome is able to provide high-quality repairs and quick repair turnaround times. By owning it's own diamond-cutting facility, Accutome is able to offer a diamond knife exchange program, allowing you to upgrade or change blade designs as your incision needs change.

## Features

- Unsurpassed sharpness
- Titanium and aluminum handles
- Lifetime warranty on titanium handles
- More cost effective than metal blades
- Variety of sizes and configurations available to fit your surgical needs

Please contact your Accutome sales representative at (800) 979.2020 or visit us on the web at [www.accutome.com](http://www.accutome.com) for additional information on our complete diamond knife product line.



## PHACO INCISION DIAMOND KNIVES

| Item #  | Description   | Image |
|---|---|-------|
| <b>Simplicity Series</b>  |   |       |
| The Simplicity Series is the perfect blend of design and craftsmanship, helping make superior corneal incisions. The blade features a unique top and bottom bevel design, which creates a self-sealing incision without having to applanate or “dimple down”. Various blade sizes available with four sharp sides. Handle is 100% titanium with J-locking mechanism and angled blade holder.  |   |       |
| AK6419  | <b>2.2mm Clear Cornea Blade</b><br>2.2mm blade width.   |       |
| AK6424  | <b>2.4mm Clear Cornea Blade</b><br>2.4mm blade width.   |       |
| AK6415  | <b>2.5mm Clear Cornea Blade</b><br>2.5mm blade width.   |       |
| AK6410  | <b>2.65mm Clear Cornea Blade</b><br>2.65mm blade width.   |       |
| AK6427  | <b>2.75mm Clear Cornea Blade</b><br>2.75mm blade width.   |       |
| AK6411  | <b>2.8mm Clear Cornea Blade</b><br>2.8mm blade width.   |       |
| AK6412  | <b>3.0mm Clear Cornea Blade</b><br>3.0mm blade width.   |       |
| AK6413  | <b>3.2mm Clear Cornea Blade</b><br>3.2mm blade width.   |       |
| <b>Simplicity Trapezoid Series</b>  |   |       |
| The Simplicity Trapezoid Series is the perfect blend of design and craftsmanship, helping make superior corneal incisions. It features a blade with a unique top and bottom bevel design, which creates a self-sealing incision without having to applanate or “dimple down”. Four sharp sided, trapezoid shaped blades with two different blade widths allowing for a small or large incision. Handle is 100% titanium with J-locking mechanism and angled blade holder. |   |       |
| AK6449  | <b>2.2mm/2.4mm Trapezoid Blade</b><br>2.2mm width at front of blade (width 1) and 2.4mm width blade at back of blade (width 2).   |       |
| AK6450  | <b>2.5mm/2.8mm Trapezoid Blade</b><br>2.5mm width at front of blade (width 1) and 2.8mm width blade at back of blade (width 2).   |       |
| AK6459  | <b>2.5mm/2.9mm Trapezoid Blade</b><br>2.5mm width at front of blade (width 1) and 2.9mm width blade at back of blade (width 2).   |       |
| AK6461  | <b>2.5mm/3.0mm Trapezoid Blade</b><br>2.5mm width at front of blade (width 1) and 3.0mm width blade at back of blade (width 2).   |       |
| AK6465  | <b>2.5mm/3.5mm Trapezoid Blade</b><br>2.5mm width at front of blade (width 1) and 3.5mm width blade at back of blade (width 2).   |       |
| AK6451  | <b>2.65mm/3.0mm Trapezoid Blade</b><br>2.65mm width at front of blade (width 1) and 3.0mm width blade at back of blade (width 2). |       |

## PHACO INCISION DIAMOND KNIVES

| Item # | Description   | Image |
|--------|---|-------|
| AK6452 | <b>2.7mm/3.2mm Trapezoid Blade</b><br>2.7mm width at front of blade (width 1) and 3.2mm width blade at back of blade (width 2). |       |
| AK6453 | <b>2.8mm/3.0mm Trapezoid Blade</b><br>2.8mm width at front of blade (width 1) and 3.0mm width blade at back of blade (width 2). |       |
| AK6458 | <b>2.8mm/3.2mm Trapezoid Blade</b><br>2.8mm width at front of blade (width 1) and 3.2mm width blade at back of blade (width 2). |       |
| AK6454 | <b>3.0mm/3.2mm Trapezoid Blade</b><br>3.0mm width at front of blade (width 1) and 3.2mm width blade at back of blade (width 2). |       |
| AK6455 | <b>3.0mm/3.5mm Trapezoid Blade</b><br>3.0mm width at front of blade (width 1) and 3.5mm width blade at back of blade (width 2). |       |
| AK6456 | <b>3.2mm/3.5mm Trapezoid Blade</b><br>3.2mm width at front of blade (width 1) and 3.5mm width blade at back of blade (width 2). |       |

**Dual Bevel Diamond Knife (Dual Sides Sharp)**

The Dual Bevel series provides a great combination of performance and affordability. Every Accutome blade is manufactured to the highest quality and specifications inside of our Accutome facility. Various blade sizes available with two sharp sides. Handle is 100% titanium with J-locking mechanism and angled blade holder.

|           |   |  |
|-----------|---|--|
| AK6007S   | <b>1.65mm Dual Bevel Blade</b><br>1.65mm blade width. |  |
| AK6009S   | <b>2.2mm Dual Bevel Blade</b><br>2.2mm blade width.   |  |
| AK6023S   | <b>2.4mm Dual Bevel Blade</b><br>2.4mm blade width.   |  |
| AK6005-45 | <b>2.5mm Dual Bevel Blade</b><br>2.5mm blade width.   |  |
| AK6000-45 | <b>2.65mm Dual Bevel Blade</b><br>2.65mm blade width. |  |
| AK6001-45 | <b>2.8mm Dual Bevel Blade</b><br>2.8mm blade width.   |  |
| AK6002-45 | <b>3.0mm Dual Bevel Blade</b><br>3.0mm blade width.   |  |
| AK6003-45 | <b>3.2mm Dual Bevel Blade</b><br>3.2mm blade width.   |  |

## PHACO INCISION DIAMOND KNIVES

| Item #  | Description   | Image |
|---|---|-------|
| <b>Dual Bevel Diamond Knife (Four Sides Sharp)</b>  |   |       |
| The Dual Bevel Series provides a great combination of performance and affordability. Every Accutome blade is manufactured to the highest quality and specifications inside of our Accutome facility. Various blade sizes available with four sharp sides. Handle is 100% titanium with J-locking mechanism and angled blade holder. |   |       |
| AK6017S   | <b>1.65mm Dual Bevel Blade</b><br>1.65mm blade width. |       |
| AK6021S   | <b>1.8mm Dual Bevel Blade</b><br>1.8mm blade width.   |       |
| AK6022S   | <b>2.0mm Dual Bevel Blade</b><br>2.0mm blade width.   |       |
| AK6019S   | <b>2.2mm Dual Bevel Blade</b><br>2.2mm blade width.   |       |
| AK6024S   | <b>2.4mm Dual Bevel Blade</b><br>2.4mm blade width.   |       |
| AK6015-45   | <b>2.5mm Dual Bevel Blade</b><br>2.5mm blade width.   |       |
| AK6010-45   | <b>2.65mm Dual Bevel Blade</b><br>2.65mm blade width. |       |
| AK6011-45   | <b>2.8mm Dual Bevel Blade</b><br>2.8mm blade width.   |       |
| AK6012-45   | <b>3.0mm Dual Bevel Blade</b><br>3.0mm blade width.   |       |
| AK6013-45   | <b>3.2mm Dual Bevel Blade</b><br>3.2mm blade width.   |       |

**Dual Bevel Trapezoid Diamond Knife**

The Dual Bevel series provides a great combination of performance and affordability. Every Accutome blade is manufactured to the highest quality and specifications inside of our Accutome facility. Four sharp sided, trapezoid shaped blades with two different blade widths allowing for a small or large incision. Handle is 100% titanium with J-locking mechanism and angled blade holder.

|           |   |  |
|-----------|---|--|
| AK6047    | <b>1.2mm/1.4mm Trapezoid Blade</b><br>1.2mm width at front of blade (width 1) and 1.4mm width blade at back of blade (width 2). |  |
| AK6072    | <b>2.0mm/2.2mm Trapezoid Blade</b><br>2.0mm width at front of blade (width 1) and 2.2mm width blade at back of blade (width 2). |  |
| AK6070-60 | <b>2.2mm/2.5mm Trapezoid Blade</b><br>2.2mm width at front of blade (width 1) and 2.5mm width blade at back of blade (width 2). |  |
| AK6050    | <b>2.5mm/2.8mm Trapezoid Blade</b><br>2.5mm width at front of blade (width 1) and 2.8mm width blade at back of blade (width 2). |  |

## PHACO INCISION DIAMOND KNIVES

| Item # | Description   | Image |
|--------|---|-------|
| AK6059 | <b>2.5mm/2.9mm Trapezoid Blade</b><br>2.5mm width at front of blade (width 1) and 2.9mm width blade at back of blade (width 2).   |       |
| AK6064 | <b>2.5mm/3.0mm Trapezoid Blade</b><br>2.5mm width at front of blade (width 1) and 3.0mm width blade at back of blade (width 2).   |       |
| AK6060 | <b>2.5mm/3.2mm Trapezoid Blade</b><br>2.5mm width at front of blade (width 1) and 3.2mm width blade at back of blade (width 2).   |       |
| AK6065 | <b>2.5mm/3.5mm Trapezoid Blade</b><br>2.5mm width at front of blade (width 1) and 3.5mm width blade at back of blade (width 2).   |       |
| AK6051 | <b>2.65mm/3.0mm Trapezoid Blade</b><br>2.65mm width at front of blade (width 1) and 3.0mm width blade at back of blade (width 2). |       |
| AK6052 | <b>2.7mm/3.2mm Trapezoid Blade</b><br>2.7mm width at front of blade (width 1) and 3.2mm width blade at back of blade (width 2).   |       |
| AK6053 | <b>2.8mm/3.0mm Trapezoid Blade</b><br>2.8mm width at front of blade (width 1) and 3.0mm width blade at back of blade (width 2).   |       |
| AK6058 | <b>2.8mm/3.2mm Trapezoid Blade</b><br>2.8mm width at front of blade (width 1) and 3.2mm width blade at back of blade (width 2).   |       |
| AK6067 | <b>2.8mm/3.5mm Trapezoid Blade</b><br>2.8mm width at front of blade (width 1) and 3.5mm width blade at back of blade (width 2).   |       |
| AK6054 | <b>3.0mm/3.2mm Trapezoid Blade</b><br>3.0mm width at front of blade (width 1) and 3.2mm width blade at back of blade (width 2).   |       |

## SPECIALTY DIAMOND KNIVES

| Item #   | Description                                       | Image |
|--|---|-------|
| <b>Crescent Diamond Knife</b>  |   |       |
| Accutome's Crescent blades are manufactured in-house, making it a high-quality product at an affordable price. Crescent blades have rounded blade tips that are available in various blade widths. Handle is 100% titanium with J-locking mechanism and angled blade holder. |   |       |
| AK6044   | <b>1.0mm Crescent Blade</b><br>1.0mm blade width. |       |
| AK6040   | <b>1.4mm Crescent Blade</b><br>1.4mm blade width. |       |
| AK6041   | <b>2.0mm Crescent Blade</b><br>2.0mm blade width. |       |



## SPECIALTY DIAMOND KNIVES

| Item # | Description | Image |
|--------|-------------|-------|
|--------|-------------|-------|

**Sclerostomy Diamond Knife**

Designed for implanting the Ex-Press filtration device. Blade measures 0.4mm in width and has two sharp sides. Handle is 100% titanium with J-locking mechanism and straight blade holder.

|        |                           |  |
|--------|---------------------------|--|
| AK6180 | <b>Sclerostomy Lancet</b> |  |
|--------|---------------------------|--|

**Universal Cataract Diamond Knife**

Accutome's Universal Cataract diamond knives are manufactured in-house, making it a high-quality product at an affordable price. The Universal and Surgeon's Choice blades measure 1.0mm in width and have four sharp sides. Handle is 100% titanium with J-locking mechanism and straight blade holder.

|        |   |  |
|--------|---|--|
| AK6030 | <b>1.0mm Universal Blade</b><br>No footplate, regular handle. |  |
|--------|---|--|



|          |   |  |
|----------|---|--|
| AK6230-2 | <b>Dual Preset Surgeon's Choice Blade</b><br>Footplate blade with step handle that has 0.3, 0.6, and full extension increments for increased versatility. |  |
|----------|---|--|



|          |   |  |
|----------|---|--|
| AK6230-3 | <b>Triple Preset Surgeon's Choice Blade</b><br>Footplate blade with step handle that has 0.5, 0.55, 0.6, and full extension increments for increased versatility. |  |
|----------|---|--|



## PARACENTESIS/STAB DIAMOND KNIVES

| Item # | Description | Image |
|--------|-------------|-------|
|--------|-------------|-------|

**Hawkeye Series**

Hawkeye Series knives are the most used knives in all of ophthalmic surgery. The Hawkeye Series provides great value and sharpness for paracentesis incisions. Every Accutome blade is manufactured to the highest quality and specifications inside of our Accutome facility. These lancet blades measure 1.0mm in width and come in various styles with either a straight or angled holder. Handle is aluminum with J-locking mechanism.

|        |   |  |
|--------|---|--|
| AK6130 | <b>0.7mm Truncated Lancet</b><br>0.7mm truncated lancet blade with straight holder. |  |
|--------|---|--|



## PARACENTESIS/STAB DIAMOND KNIVES

| Item #  | Description  | Image |
|---------|--|-------|
| AK6I50  | <b>0.7mm Hawkeye Trifacet</b><br>0.7mm trifacet truncated lancet blade with straight holder. |       |
| AK6I60  | <b>1.0mm Truncated Lancet</b><br>1.0mm truncated lancet blade with straight holder.          |       |
| AK6I60A | <b>1.0mm Angled Truncated Lancet</b><br>1.0mm truncated lancet blade with angled holder.     |       |
| AK6I75  | <b>1.0mm Lancet</b><br>1.0mm lancet blade with straight holder.                              |       |
| AK6I75A | <b>1.0mm Angled Lancet</b><br>1.0mm lancet blade with angled holder.                         |       |

**Hawkeye Premium Series**

The Hawkeye Premium Series is manufactured in-house, making it a high-quality product at an affordable price. The blades measure 1.0mm in width and come in various styles. Handle is 100% titanium with J-locking mechanism and straight holders.

|           |   |  |
|-----------|---|--|
| AK50I5    | <b>1.0mm Trifacet Freehand</b><br>Trifacet blade with two sides sharp.        |  |
| AK6026    | <b>45-Degree Single-Edge Freehand</b><br>45-degree blade with one side sharp. |  |
| AK60I6-60 | <b>1.0mm Clear Cornea Lancet</b><br>Blade with four sides sharp.              |  |

## ASTIGMATISM MANAGEMENT DIAMOND KNIVES

| Item #   | Description  | Image |
|--|--|-------|
| <b>Donnenfeld Preset LRI, Long Handle</b>  |  |       |
| Please note that custom preset options are available. These long-handled preset Donnenfeld lancet blades are available in various desired preset specifications. Blades are at a 15-degree angle for better applanation, are 1.0mm in width, and have a winged footplate for superior control. Handle is 100% titanium and measures 4.5 inches long. |  |       |
| AK6I75PT200  | <b>Donnenfeld Preset LRI, 200 Micron</b><br>Lancet blade with 200 micron depth preset. |       |
| AK6I75PT250  | <b>Donnenfeld Preset LRI, 250 Micron</b><br>Lancet blade with 250 micron depth preset. |       |
| AK6I75PT300  | <b>Donnenfeld Preset LRI, 300 Micron</b><br>Lancet blade with 300 micron depth preset. |       |
| AK6I75PT350  | <b>Donnenfeld Preset LRI, 350 Micron</b><br>Lancet blade with 350 micron depth preset. |       |
| AK6I75PT400  | <b>Donnenfeld Preset LRI, 400 Micron</b><br>Lancet blade with 400 micron depth preset. |       |
| AK6I75PT450  | <b>Donnenfeld Preset LRI, 450 Micron</b><br>Lancet blade with 450 micron depth preset. |       |
| AK6I75PT500  | <b>Donnenfeld Preset LRI, 500 Micron</b><br>Lancet blade with 500 micron depth preset. |       |
| AK6I75PT550  | <b>Donnenfeld Preset LRI, 550 Micron</b><br>Lancet blade with 550 micron depth preset. |       |
| AK6I75PT600  | <b>Donnenfeld Preset LRI, 600 Micron</b><br>Lancet blade with 600 micron depth preset. |       |

**Donnenfeld Preset LRI, Short Handle**

Please note that custom preset options are available. These short-handled preset Donnenfeld lancet blades are available in various desired preset specifications. Blades are at a 15-degree angle for better applanation, are 1.0mm in width, and have a winged footplate for superior control. Handle is 100% titanium and measures 2.625 inches long.

|              |  |  |
|--------------|--|--|
| AK6I75SPT200 | <b>Donnenfeld Preset LRI, 200 Micron</b><br>Lancet blade with 200 micron depth preset. |  |
| AK6I75SPT250 | <b>Donnenfeld Preset LRI, 250 Micron</b><br>Lancet blade with 250 micron depth preset. |  |
| AK6I75SPT300 | <b>Donnenfeld Preset LRI, 300 Micron</b><br>Lancet blade with 300 micron depth preset. |  |
| AK6I75SPT350 | <b>Donnenfeld Preset LRI, 350 Micron</b><br>Lancet blade with 350 micron depth preset. |  |
| AK6I75SPT400 | <b>Donnenfeld Preset LRI, 400 Micron</b><br>Lancet blade with 400 micron depth preset. |  |
| AK6I75SPT450 | <b>Donnenfeld Preset LRI, 450 Micron</b><br>Lancet blade with 450 micron depth preset. |  |
| AK6I75SPT500 | <b>Donnenfeld Preset LRI, 500 Micron</b><br>Lancet blade with 500 micron depth preset. |  |
| AK6I75SPT550 | <b>Donnenfeld Preset LRI, 550 Micron</b><br>Lancet blade with 550 micron depth preset. |  |
| AK6I75SPT600 | <b>Donnenfeld Preset LRI, 600 Micron</b><br>Lancet blade with 600 micron depth preset. |  |

## ASTIGMATISM MANAGEMENT DIAMOND KNIVES



| Item #  | Description   | Image |
|---|---|-------|
| <b>Donnenfeld Preset Truncated Lancet, Long Handle</b>  |   |       |
| Please note that custom preset options are available. These long-handled preset Donnenfeld truncated lancet blades are available in various desired preset specifications. Blades are at a 15-degree angle for better appplanation, are 1.0mm in width, and have a winged footplate for superior control. Handle is 100% titanium and measures 4.5 inches long. |   |       |
| AK6I60PT200   | <b>Donnenfeld Preset Truncated Lancet, 200 Micron</b><br>Truncated lancet blade with 200 micron depth preset. |       |
| AK6I60PT250   | <b>Donnenfeld Preset Truncated Lancet, 250 Micron</b><br>Truncated lancet blade with 250 micron depth preset. |       |
| AK6I60PT300   | <b>Donnenfeld Preset Truncated Lancet, 300 Micron</b><br>Truncated lancet blade with 300 micron depth preset. |       |
| AK6I60PT350   | <b>Donnenfeld Preset Truncated Lancet, 350 Micron</b><br>Truncated lancet blade with 350 micron depth preset. |       |
| AK6I60PT400   | <b>Donnenfeld Preset Truncated Lancet, 400 Micron</b><br>Truncated lancet blade with 400 micron depth preset. |       |
| AK6I60PT450   | <b>Donnenfeld Preset Truncated Lancet, 450 Micron</b><br>Truncated lancet blade with 450 micron depth preset. |       |
| AK6I60PT500   | <b>Donnenfeld Preset Truncated Lancet, 500 Micron</b><br>Truncated lancet blade with 500 micron depth preset. |       |
| AK6I60PT550   | <b>Donnenfeld Preset Truncated Lancet, 550 Micron</b><br>Truncated lancet blade with 550 micron depth preset. |       |
| AK6I60PT600   | <b>Donnenfeld Preset Truncated Lancet, 600 Micron</b><br>Truncated lancet blade with 600 micron depth preset. |       |

**Donnenfeld Preset Truncated Lancet, Short Handle**

Please note that custom preset options are available. These short-handled preset Donnenfeld truncated lancet blades are available in various desired preset specifications. Blades are at a 15-degree angle for better appplanation, are 1.0mm in width, and have a winged footplate for superior control. Handle is 100% titanium and measures 2.625 inches long.

|              |   |  |
|--------------|---|--|
| AK6I60SPT200 | <b>Donnenfeld Preset Truncated Lancet, 200 Micron</b><br>Truncated lancet blade with 200 micron depth preset. |  |
| AK6I60SPT250 | <b>Donnenfeld Preset Truncated Lancet, 250 Micron</b><br>Truncated lancet blade with 250 micron depth preset. |  |
| AK6I60SPT300 | <b>Donnenfeld Preset Truncated Lancet, 300 Micron</b><br>Truncated lancet blade with 300 micron depth preset. |  |
| AK6I60SPT350 | <b>Donnenfeld Preset Truncated Lancet, 350 Micron</b><br>Truncated lancet blade with 350 micron depth preset. |  |
| AK6I60SPT400 | <b>Donnenfeld Preset Truncated Lancet, 400 Micron</b><br>Truncated lancet blade with 400 micron depth preset. |  |
| AK6I60SPT450 | <b>Donnenfeld Preset Truncated Lancet, 450 Micron</b><br>Truncated lancet blade with 450 micron depth preset. |  |
| AK6I60SPT500 | <b>Donnenfeld Preset Truncated Lancet, 500 Micron</b><br>Truncated lancet blade with 500 micron depth preset. |  |
| AK6I60SPT550 | <b>Donnenfeld Preset Truncated Lancet, 550 Micron</b><br>Truncated lancet blade with 550 micron depth preset. |  |
| AK6I60SPT600 | <b>Donnenfeld Preset Truncated Lancet, 600 Micron</b><br>Truncated lancet blade with 600 micron depth preset. |  |

## ASTIGMATISM MANAGEMENT DIAMOND KNIVES

| Item #  | Description   | Image  |
|---|---|--|
| <b>Chang LRI Diamond Knife</b>  |   |  |
| A 1.0mm wide lancet blade developed specifically for correcting astigmatism using an intraoperative wavefront aberrometer. Customized, 3.5-inch, gold, aluminum, straight handle design to provide better control within shorter working distance. Winged footplate provides superior visualization and reduces epithelium drag. Highest quality preset diamond blade. Fully retractable J-locking mechanism for blade and sharps protection. |   |  |
| AK6I75PC  | <a href="#">Chang LRI Diamond Knife</a>   |  |
| <b>Rubenstein Preset LRI, Long Handle</b>   |   |  |
| Please note that custom preset options are available. These long-handed Rubenstein Preset LRI lancet diamond knives measure 1.0mm in width and are available in various desired preset specifications. Winged footplate for superior control. Handle is straight aluminum and measures 4.75 inches long.  |   |  |
| AK6I75P200  | <a href="#">Rubenstein Preset LRI, 200 Micron</a><br>Lancet blade with 200 micron depth preset. |  |
| AK6I75P250  | <a href="#">Rubenstein Preset LRI, 250 Micron</a><br>Lancet blade with 250 micron depth preset. |  |
| AK6I75P300  | <a href="#">Rubenstein Preset LRI, 300 Micron</a><br>Lancet blade with 300 micron depth preset. |  |
| AK6I75P350  | <a href="#">Rubenstein Preset LRI, 350 Micron</a><br>Lancet blade with 350 micron depth preset. |  |
| AK6I75P400  | <a href="#">Rubenstein Preset LRI, 400 Micron</a><br>Lancet blade with 400 micron depth preset. |  |
| AK6I75P450  | <a href="#">Rubenstein Preset LRI, 450 Micron</a><br>Lancet blade with 450 micron depth preset. |  |
| AK6I75P500  | <a href="#">Rubenstein Preset LRI, 500 Micron</a><br>Lancet blade with 500 micron depth preset. |  |
| AK6I75P550  | <a href="#">Rubenstein Preset LRI, 550 Micron</a><br>Lancet blade with 550 micron depth preset. |  |
| AK6I75P600  | <a href="#">Rubenstein Preset LRI, 600 Micron</a><br>Lancet blade with 600 micron depth preset. |  |



## ASTIGMATISM MANAGEMENT DIAMOND KNIVES

| Item #  | Description   | Image |
|---|---|-------|
| <b>Rubenstein Preset Truncated Lancet, Long Handle</b>  |   |       |
| Please note that custom preset options are available. These long-handled Rubenstein Preset truncated lancet diamond knives measure 1.0mm in width and are available in various desired preset specifications. Winged footplate for superior control. Handle is straight aluminum and measures 4.75 inches long. |   |       |
| AK6I60P200  | <b>Rubenstein Preset Truncated Lancet, 200 Micron</b><br>Truncated lancet blade with 200 micron depth preset. |       |
| AK6I60P250  | <b>Rubenstein Preset Truncated Lancet, 250 Micron</b><br>Truncated lancet blade with 250 micron depth preset. |       |
| AK6I60P300  | <b>Rubenstein Preset Truncated Lancet, 300 Micron</b><br>Truncated lancet blade with 300 micron depth preset. |       |
| AK6I60P350  | <b>Rubenstein Preset Truncated Lancet, 350 Micron</b><br>Truncated lancet blade with 350 micron depth preset. |       |
| AK6I60P400  | <b>Rubenstein Preset Truncated Lancet, 400 Micron</b><br>Truncated lancet blade with 400 micron depth preset. |       |
| AK6I60P450  | <b>Rubenstein Preset Truncated Lancet, 450 Micron</b><br>Truncated lancet blade with 450 micron depth preset. |       |
| AK6I60P500  | <b>Rubenstein Preset Truncated Lancet, 500 Micron</b><br>Truncated lancet blade with 500 micron depth preset. |       |
| AK6I60P550  | <b>Rubenstein Preset Truncated Lancet, 550 Micron</b><br>Truncated lancet blade with 550 micron depth preset. |       |
| AK6I60P600  | <b>Rubenstein Preset Truncated Lancet, 600 Micron</b><br>Truncated lancet blade with 600 micron depth preset. |       |

**Rubenstein Preset LRI, Short Handle**

Please note that custom preset options are available. These short-handled Rubenstein Preset LRI lancet diamond knives measure 1.0mm in width and are available in various desired preset specifications. Winged footplate for superior control. Handle is straight aluminum and measures 2.75 inches long.

|             |  |  |
|-------------|--|--|
| AK6I75SP200 | <b>Rubenstein Preset LRI, 200 Micron</b><br>Lancet blade with 200 micron depth preset. |  |
| AK6I75SP250 | <b>Rubenstein Preset LRI, 250 Micron</b><br>Lancet blade with 250 micron depth preset. |  |
| AK6I75SP300 | <b>Rubenstein Preset LRI, 300 Micron</b><br>Lancet blade with 300 micron depth preset. |  |
| AK6I75SP350 | <b>Rubenstein Preset LRI, 350 Micron</b><br>Lancet blade with 350 micron depth preset. |  |
| AK6I75SP400 | <b>Rubenstein Preset LRI, 400 Micron</b><br>Lancet blade with 400 micron depth preset. |  |
| AK6I75SP450 | <b>Rubenstein Preset LRI, 450 Micron</b><br>Lancet blade with 450 micron depth preset. |  |
| AK6I75SP500 | <b>Rubenstein Preset LRI, 500 Micron</b><br>Lancet blade with 500 micron depth preset. |  |
| AK6I75SP550 | <b>Rubenstein Preset LRI, 550 Micron</b><br>Lancet blade with 550 micron depth preset. |  |

## ASTIGMATISM MANAGEMENT DIAMOND KNIVES

| Item #      | Description  | Image |
|-------------|--|-------|
| AK6175SP600 | <b>Rubenstein Preset LRI, 600 Micron</b><br>Lancet blade with 600 micron depth preset. |       |

**Surgeon's Choice Adjustable**

Please note that any diamond knife orders will be processed as separate orders in house. Other pre-set options are available upon request. Blade with various adjustable pre-set handle steps. Blade measures 1.0mm in width and each knife has a wide footplate design. Handle is 100% titanium and has a straight holder.

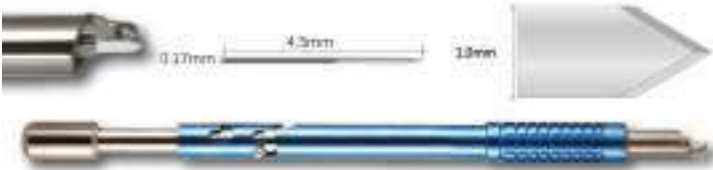

|          |   |  |
|----------|---|--|
| AK6216   | <b>1.0mm Clear Cornea Blade</b><br>Clear cornea blade with adjustable steps - 0.5mm, 0.55mm, 0.6mm, and full extension. |    |
| AK6235-2 | <b>1.0mm Double Preset Lancet Blade</b><br>Lancet blade with two pre-set adjustable steps - 0.3mm and 0.6mm.            |   |
| AK6235-3 | <b>1.0mm Triple Preset Lancet Blade</b><br>Lancet blade with three preset adjustable steps - 0.5mm, 0.55mm, and 0.6mm.  |  |

**Micrometer**

Variety of 1.0mm blade styles mounted in an adjustable micrometer handle. Dual footplate for superior control. 100% titanium handle.

|        |  |  |
|--------|--|--|
| AK5003 | <b>15-Degree Micrometer</b><br>15-Degree Arcuate Blade mounted in an adjustable micrometer handle.         |  |
| AK5002 | <b>45-Degree Micrometer</b><br>Single edge, 45-degree RK Blade mounted in an adjustable micrometer handle. |  |
| AK5005 | <b>45-Degree Micrometer</b><br>Double edge, 45-degree blade mounted in an adjustable micrometer handle.    |  |

## ASTIGMATISM MANAGEMENT DIAMOND KNIVES

| Item # | Description  | Image   |
|--------|--|---|
| AK5004 | <p data-bbox="261 323 467 344"><b>Tri-Square Micrometer</b></p> <p data-bbox="261 359 727 401">Tri-Square (Triple 90) Blade mounted in an adjustable micrometer handle.</p>                          |  <p>The image shows the AK5004 Tri-Square Micrometer. It consists of a blue adjustable micrometer handle and a diamond blade. The blade is shown in a separate view with dimensions: a width of 0.17mm, a length of 4.5mm, and a thickness of 1.0mm.</p>  |
| AK5017 | <p data-bbox="261 516 451 537"><b>Triple 90 Micrometer</b></p> <p data-bbox="261 552 727 594">Tri-Square (Triple 90) Blade mounted in an adjustable micrometer handle. 250 micron cutting depth.</p> |  <p>The image shows the AK5017 Triple 90 Micrometer. It consists of a blue adjustable micrometer handle and a diamond blade. The blade is shown in a separate view with dimensions: a width of 0.17mm, a length of 4.5mm, and a thickness of 1.0mm. A cutting depth of 250 microns is also indicated.</p> |

# Bipolar Instruments

**BIPOLAR CABLES & PROBES**

| Item # | Description | Image |
|--------|-------------|-------|
|--------|-------------|-------|

**Bipolar Cables**

Reusable TPR (thermoplastic rubber) bipolar cables 12 inches, straight connection, universal 2 pin fitting. Fits 4mm banana-plug style generators. Good for use with steam sterilization.

|        |  |  |
|--------|--|--|
| AM0830 | <p><b>Straight Bipolar Cable</b><br/>Straight connector.</p> |  |
|--------|--|--|

|        |   |   |
|--------|---|---|
| AM0831 | <p><b>Angled Bipolar Cable</b><br/>45-degree connector.</p> |  |
|--------|---|---|

**Cautery Probe**

Straight tip. Reusable.



|        |   |  |
|--------|---|--|
| AF0160 | <p><b>Cautery Probe 18g</b><br/>18 gauge probe.</p> |  |
| AF0162 | <p><b>Cautery Probe 20g</b><br/>20 gauge probe.</p> |  |

**BIPOLAR FORCEPS**







| Item # | Description | Image |
|--------|-------------|-------|
|--------|-------------|-------|

**Adson Bipolar Forceps**

Straight shafts, 1.0mm wide tips. Flat handle. Overall length: 127mm.

|        |  |  |
|--------|--|--|
| AF0125 | <p><b>Adson Bipolar Forceps, Straight</b><br/>1.0mm wide serrated tips. Insulated handle. Overall length: 127mm.</p> |  |
| AF0127 | <p><b>Adson Bipolar Forceps, Straight</b><br/>1.0mm wide non-stick tips. Overall length: 127mm.</p>                  |  |

**BIPOLAR FORCEPS**

| Item #  | Description  | Image  |
|---|--|--|
| <b>Coaptation Bipolar Forceps</b>   |  |  |
| Curved shafts, angled 0.6mm wide non-stick tips, wide, flat handle. Non-insulated. Overall length: 114mm. |  |  |
| AF0100  | <a href="#">Coaptation Bipolar Forceps</a>   |    |
| <b>Jewelers Bipolar Forceps</b>   |  |  |
| Straight shafts with fine pointed tips. Smooth handle with dull finish. Overall length: 120mm.            |  |  |
| AF0120  | <a href="#">Non-insulated Jewelers Bipolar Forceps</a><br>Non-insulated.               |    |
| AF0120 IN   | <a href="#">Insulated Jewelers Bipolar Forceps</a><br>Insulated.                       |   |
| <b>McPherson Bipolar Forceps</b>  |  |  |
| Straight and angled shafts, 0.4mm wide non-stick tips. Flat handle. Overall length: 95mm.                 |  |  |
| AF0130  | <a href="#">McPherson Bipolar Forceps, Angled</a><br>Angled shafts, non-insulated.     |  |
| AF0130 I  | <a href="#">McPherson Bipolar Forceps, Angled</a><br>Angled shafts, insulated.         |  |
| AF0140  | <a href="#">McPherson Bipolar Forceps, Straight</a><br>Straight shafts, non-insulated. |  |



**BIPOlar FORCEPS**

| Item #   | Description                             | Image  |
|--|---|--|
| <b>Shepard Bipolar Forceps</b>   |   |  |
| Angled shafts with 4mm platform. Smooth handle with dull finish. Non-insulated. Overall length: 120mm. |   |  |
| AF0145 A   | <a href="#">Shepard Bipolar Forceps</a> |  |

# Calipers, Gauges & Markers

CALIPERS

| Item # | Description | Image |
|--------|-------------|-------|
|--------|-------------|-------|

**Braunstein Fixed Caliper**

Aphakic: 3.5mm. Phakic: 4mm. Overall length: 80mm.

|        |  |
|--------|--|
| AR0155 | <a href="#">Braunstein Fixed Caliper</a> |
|--------|--|



**Castroviejo Caliper**

Measures 0mm-20mm in 1.0mm increments. Screw-locking mechanism. Overall length: 89mm.

|        |   |
|--------|---|
| AR0140 | <a href="#">Castroviejo Caliper</a><br>Curved blades. |
|--------|---|



|        |   |
|--------|---|
| AR0150 | <a href="#">Castroviejo Caliper</a><br>Straight blades. |
|--------|---|



|          |  |
|----------|--|
| AR0150T1 | <a href="#">Castroviejo Caliper</a><br>Straight titanium blades. |
|----------|--|



**Jameson Caliper**

Angled tips, measures 0mm to 80mm with 1.0mm increments. Overall length: 95mm.



|        |                                 |
|--------|---------------------------------|
| AR0260 | <a href="#">Jameson Caliper</a> |
|--------|---------------------------------|



CALIPERS

| Item #                                | Description                   | Image  |
|---------------------------------------|-------------------------------|--|
| <b>Stahl Corneal Caliper</b>          |                               |  |
| Measures 10-13mm in 0.5mm increments. |                               |  |
| AR0380                                | <a href="#">Stahl Caliper</a> |  |





GAUGES

| Item #   | Description   | Image  |
|--|---|--|
| <b>Mendez Degree Gauge</b>   |   |  |
| Outside diameter 18mm. Inside diameter 12mm. Markings on top of instrument, 10-degree increments. Round handle. Overall length: 114mm. |   |  |
| AR0121   | <a href="#">Stainless Steel Gauge</a><br>Made from stainless steel. |  |
| AR0121TI   | <a href="#">Titanium Gauge</a><br>Made from titanium.               |  |

MARKERS

| Item #   | Description                       | Image  |
|--|-----------------------------------|--|
| <b>Bores Axis Marker</b>   |                                   |  |
| Designed to fit inside of degree gauge for axis marking. Round handle. |                                   |  |
| AR0120   | <a href="#">Bores Axis Marker</a> |  |

MARKERS

| Item #  | Description  | Image  |
|---|--|--|
| <b>Chayet Marker</b>  |  |  |
| <p>Stainless steel corneal marker that is to be used during LASIK surgery for identifying and realigning the lamellar flap. Marking pattern uses a small, medium, and large circle. Flat handle. Overall length: 106mm.</p> |  |  |
| AR4120  | <b>Chayet Marker</b>   |    |
| <b>Dell LRI Astigmatism Marker</b>  |  |  |
| <p>Titanium with axis marking blades. Rotating ring with 10 degree increments. Round, knurled handle. Overall length: 120mm.</p>  |  |  |
| AR0126  | <p><b>Gills Nomogram Marker</b><br/>6mm and 8mm chord length and axis marking blades.</p>                                      |    |
| AR0127  | <p><b>Nichamin Nomogram Marker</b><br/>40, 60, 80 degrees and axis marking blades.</p>   |   |
| AR0129  | <p><b>Nichamin Nomogram Marker</b><br/>40, 60, 80 degrees and axis marking blades. Reference marks for proper positioning.</p> |  |
| AR0132  | <p><b>Donnenfeld LRI Marker</b><br/>1, 2 clock hours (30, 60 degrees) and axis marking blades.</p>                             |  |

MARKERS

| Item # | Description | Image |
|--------|-------------|-------|
|--------|-------------|-------|

**Devgan Axis Marker**

The Devgan Axis Markers are designed to improve toric IOL axis and centration accuracy for better outcomes. The marking blades fit most standard goldman tonometer housings. Hollow center allows surgeon to center marks with pupil without the use of gentian violet ink. Markers are 6mm or 9mm on the inside of the blades and 9 to 12mm on the outside. Markers are either smooth and angled or pointed and angled. Marks 0 to 180 degrees in 10-degree increments.

AR8000 **6-9mm Marking Blade**  
 Marking blades are 6mm apart on the inside and 9mm apart on the outside. Tips of marker are smooth and angled.



AR8001 **9-12mm Marking Blade**  
 Marking blades are 9mm apart on the inside and 12mm apart on the outside. Tips of marker are smooth and angled.



AR8002 **6-9mm Marking Blade**  
 Marking blades are 6mm apart on the inside and 9mm apart on the outside. Tips of marker have three points and are angled. This tip will leave three dots on each side and is used for toric IOL marking.



**Hoffer Optical Zone Marker**

Various marker diameters with cross hairs. Round handle. Overall length: 108mm.

AR0250 4.00 **4mm Optical Zone Marker**  
 4.0mm diameter with cross hairs.

AR0250 4.50 **4.5mm Optical Zone Marker**  
 4.5mm diameter with cross hairs.

AR0250 5.00 **5.0mm Optical Zone Marker**  
 5.0mm diameter with cross hairs.



MARKERS

| Item #      | Description  | Image |
|-------------|--|-------|
| AR0250 5.50 | <b>5.5mm Optical Zone Marker</b><br>5.5mm diameter with cross hairs.   |       |
| AR0250 5.75 | <b>5.75mm Optical Zone Marker</b><br>5.75mm diameter with cross hairs. |       |
| AR0250 6.00 | <b>6.0mm Optical Zone Marker</b><br>6.0mm diameter with cross hairs.   |       |
| AR0250 8.00 | <b>8.0mm Optical Zone Marker</b><br>8.0mm diameter with cross hairs.   |       |
| AR0250 8.5  | <b>8.5mm Optical Zone Marker</b><br>8.5mm diameter with cross hairs.   |       |
| AR0250 9.00 | <b>9.0mm Optical Zone Marker</b><br>9.0mm diameter with cross hairs.   |       |

**LASIK Corneal Marker**

Three marking blades. Round handle.

|        |                             |   |
|--------|-----------------------------|---|
| AR4130 | <b>LASIK Corneal Marker</b> |  |
|--------|-----------------------------|---|

**Osher-Neumann Radial Incision Marker**

Marking blades, low profile. Round handle.

|           |  |  |
|-----------|--|--|
| AR0400 8  | <b>Osher-Neumann Radial Marker</b><br>8 marking blades.  |  |
| AR0400 12 | <b>Osher-Neumann Radial Marker</b><br>12 marking blades. |  |



MARKERS

| Item # | Description | Image |
|--------|-------------|-------|
|--------|-------------|-------|

**Plain Optical Zone Marker**

Open circle tip with various diameter sizes and low profile design. Round Handle. Overall length: 95mm.

|             |   |
|-------------|---|
| AR0370 2.50 | <b>2.5mm Optical Zone Marker</b><br>2.5mm diameter.   |
| AR0370 3.00 | <b>3.0mm Optical Zone Marker</b><br>3.0mm diameter.   |
| AR0370 3.50 | <b>3.5mm Optical Zone Marker</b><br>3.5mm diameter.   |
| AR0370 4.00 | <b>4.0mm Optical Zone Marker</b><br>4.0mm diameter.   |
| AR0370 5.00 | <b>5.0mm Optical Zone Marker</b><br>5.0mm diameter.   |
| AR0370 5.75 | <b>5.75mm Optical Zone Marker</b><br>5.75mm diameter. |
| AR0370 6.00 | <b>6.0mm Optical Zone Marker</b><br>6.0mm diameter.   |
| AR0370 7.00 | <b>7.0mm Optical Zone Marker</b><br>7.0mm diameter.   |
| AR0370 8.00 | <b>8.0mm Optical Zone Marker</b><br>8.0mm diameter.   |
| AR0370 9.00 | <b>9.0mm Optical Zone Marker</b><br>9.0mm diameter.   |



**Rubenstein LASIK Corneal Marker**

Five marking blades. Flat handle.

|        |  |
|--------|--|
| AR4150 | <b>Rubenstein LASIK Corneal Marker</b> |
|--------|--|



**Toric Lens Marker**

Titanium. Axis marking blades. Rotating ring with 10-degree increments. Round, knurled handle.

|        |  |
|--------|--|
| AR0146 | <b>Toric Lens Marker</b><br>Overall length: 127mm. |
| AR0148 | <b>Toric Lens Marker</b><br>Overall length: 120mm. |



## MARKERS

| Item #  | Description                            | Image  |
|---|--|--|
| <b>Toric Reference Marker</b>   |  |  |
| Three marking blades at 0, 90, and 180 degrees. 15mm diameter. Designed for marking with patient in the upright position. |  |  |
| AR0145  | <a href="#">Toric Reference Marker</a> |  |

# Cannulas & Cystotomes

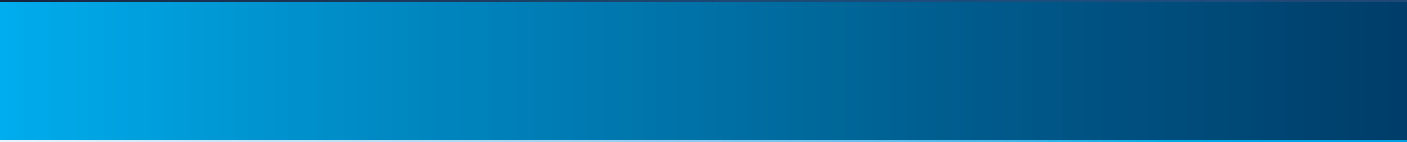
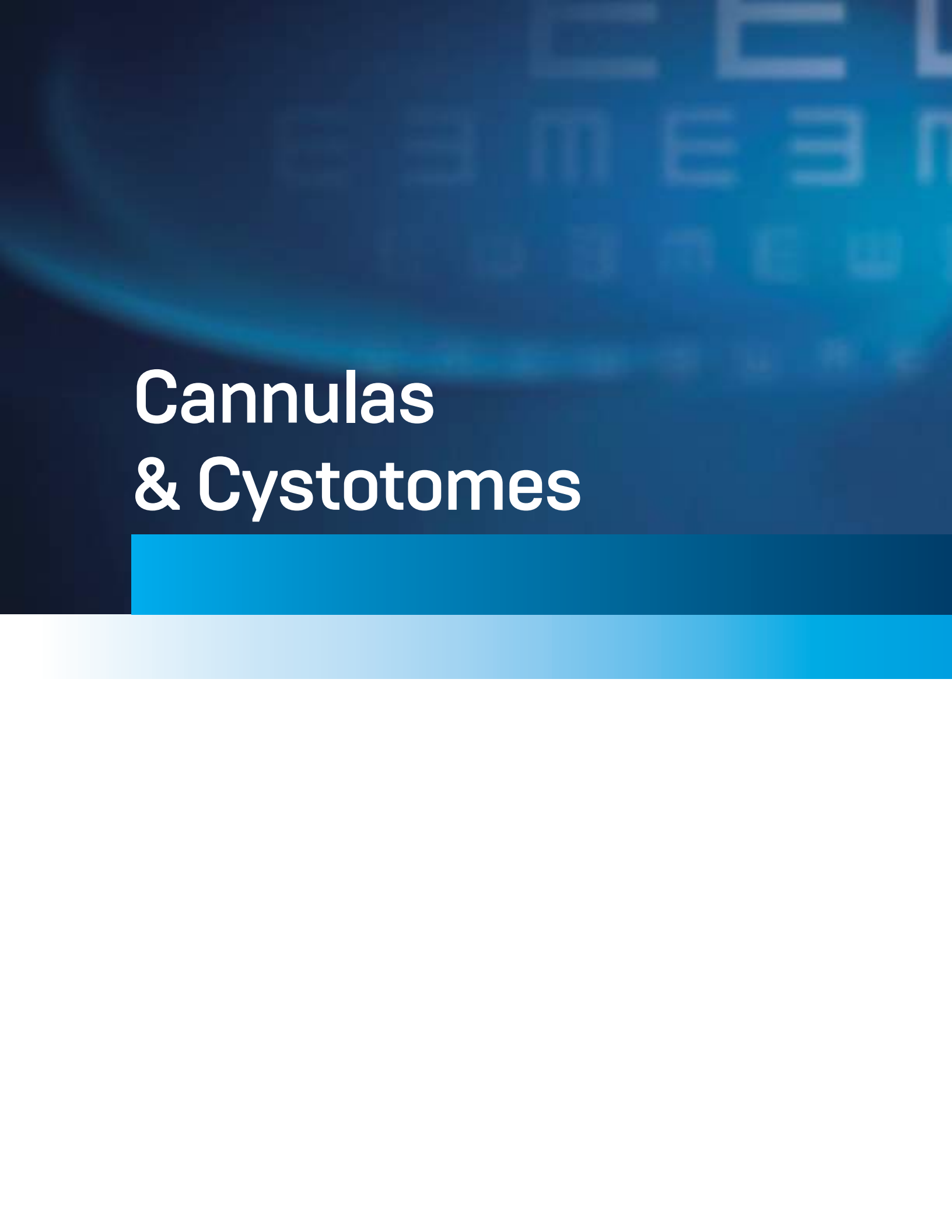

**ACCUSURGICAL SINGLE-USE CANNULAS & CYSTOTOMES**

| Item # | Description | Image |
|--------|-------------|-------|
|--------|-------------|-------|

**Atkinson Retrobulbar Needle**

The Atkinson Retrobulbar Needle has a straight shaft and needle tip. Disposable, sold 10 per box. Overall length: 38mm.

|          |   |
|----------|---|
| AXI0414  | <b>Retrobulbar Needle, 23g</b><br>23 gauge. |
| AXIII637 | <b>Retrobulbar Needle, 25g</b><br>25 gauge. |
| AXI4571  | <b>Retrobulbar Needle, 27g</b><br>27 gauge. |

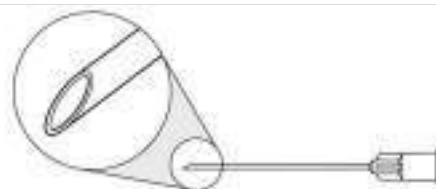

**Atkinson Peribulbar Needle**

The AccuSurgical disposable Atkinson Peribulbar Needle has a straight shaft and needle tip. Available between 16mm and 32mm total length and 23 to 27 gauge. Sold 10 per box.

|          |  |
|----------|--|
| AXI4576  | <b>Peribulbar Needle, 23g</b><br>23 gauge. Overall length: 16mm. |
| AXI4577  | <b>Peribulbar Needle, 23g</b><br>23 gauge. Overall length: 22mm. |
| AXI0853  | <b>Peribulbar Needle, 23g</b><br>23 gauge. Overall length: 32mm. |
| AXI4572  | <b>Peribulbar Needle, 25g</b><br>25 gauge. Overall length: 16mm. |
| AXII5027 | <b>Peribulbar Needle, 25g</b><br>25 gauge. Overall length: 22mm. |
| AXIII642 | <b>Peribulbar Needle, 25g</b><br>25 gauge. Overall length: 32mm. |
| AXI4568  | <b>Peribulbar Needle, 27g</b><br>27 gauge. Overall length: 22mm. |
| AXI2045  | <b>Peribulbar Needle, 27g</b><br>27 gauge. Overall length: 32mm. |



**Non Atkinson Retrobulbar Needle**

The AccuSurgical disposable Non Atkinson Retrobulbar Needle has a straight shaft and needle tip. Available between 25 to 27 gauge with an overall length of 38mm. Sold 10 per box.

|         |  |
|---------|--|
| AXI4580 | <b>Non Atkinson Retrobulbar Needle, 25g</b><br>25 gauge. |
| AXI4581 | <b>Non Atkinson Retrobulbar Needle, 26g</b><br>26 gauge. |
| AXI4582 | <b>Non Atkinson Retrobulbar Needle, 27g</b><br>27 gauge. |

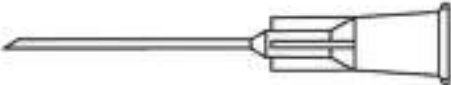

**ACCUSURGICAL SINGLE-USE CANNULAS & CYSTOTOMES**

| Item #  | Description   | Image  |
|---|---|--|
| <b>Non Atkinson Peribulbar Needle</b>   |   |  |
| The AccuSurgical disposable Non Atkinson Peribulbar Needle has a straight shaft and needle tip. Available between 23 to 30 gauge and 16mm to 25mm in overall length. Sold 10 per box. |   |  |
| AXI4585   | <b>Non Atkinson Peribulbar Needle, 23g</b><br>23 gauge. Overall length: 16mm. |  |
| AXI4586   | <b>Non Atkinson Peribulbar Needle, 25g</b><br>25 gauge. Overall length: 16mm. |  |
| AXI4584   | <b>Non Atkinson Peribulbar Needle, 25g</b><br>25 gauge. Overall length: 22mm. |  |
| AXI4583   | <b>Non Atkinson Peribulbar Needle, 25g</b><br>25 gauge. Overall length: 25mm. |  |
| AXI4587   | <b>Non Atkinson Peribulbar Needle, 27g</b><br>27 gauge. Overall length: 16mm. |  |
| AXI4588   | <b>Non Atkinson Peribulbar Needle, 30g</b><br>30 gauge. Overall length: 16mm. |  |

**Sub Tenon Anesthesia Cannula**

The AccuSurgical disposable Sub Tenon Anesthesia Cannula has either a curved or angled shaft with various tip types. Available in 19 or 21 gauge and 22mm to 25mm in overall length. Sold 10 per box.

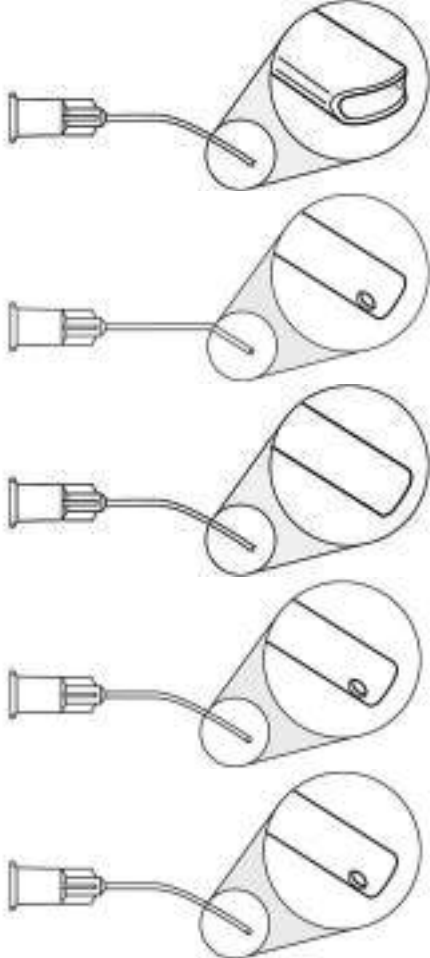
|          |   |  |
|----------|---|--|
| AXI0914  | <b>Sub Tenon Cannula, 19g</b><br>19 gauge, curved shaft, flattened tip. Overall length: 25mm.                             |  |
| AXI4593  | <b>Sub Tenon Cannula, 19g</b><br>19 gauge, angled shaft, 7mm from bend to tip, blunt tip, tri port. Overall length: 25mm. |  |
| AXI25176 | <b>Sub Tenon Cannula, 19g</b><br>19 gauge, curved shaft, open tip. Overall length: 22mm.                                  |  |
| AXI4592  | <b>Sub Tenon Cannula, 19g</b><br>19 gauge, curved shaft, blunt tip, tri port. Overall length: 25mm.                       |  |
| AXI4590  | <b>Sub Tenon Cannula, 21g</b><br>21 gauge, curved shaft, blunt tip, tri port. Overall length: 22mm.                       |  |

ACCUSURGICAL SINGLE-USE CANNULAS & CYSTOTOMES

| Item #  | Description   | Image  |
|---------|---|--|
| AXI4591 | <b>Sub Tenon Cannula, 21g</b><br>21 gauge, angled shaft, 7mm from bend to tip, blunt tip, tri port. Overall length: 22mm. |  |

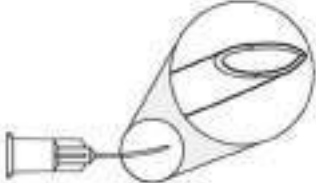

**Rous Sub Tenon/Parabulbar Needle**

19 gauge, angled shaft, 7mm from bend to tip, needle tip, tri port. Disposable, sold 10 per box. Overall length: 25mm.

|         |  |  |
|---------|--|--|
| AXI4594 | <b>Rous Sub Tenon/Parabulbar Needle, 19g</b> |  |
|---------|--|--|

**Anterior Chamber Cannula, Angled**

Our single-use Anterior Chamber Cannula, also known as Air Injection, Rycroft, and Viscoelastic cannula, is available from 19 to 30 gauge. Every cannula has a 32-degree angled shaft with blunt and polished tips for smoother radii. Overall length ranges from 22mm to 25mm. Sold 10 per box, unless specified otherwise.

| AXI4655 | <b>Anterior Chamber Cannula, 19g</b><br>19 gauge, 3mm from bend to tip. Overall length: 25mm.  | <br><br><table border="1" data-bbox="815 1024 1523 1125"> <thead> <tr> <th>3mm</th> <th>4mm</th> <th>5mm</th> <th>6mm</th> <th>7mm</th> <th>8mm</th> <th>9mm</th> <th>10mm</th> <th>11mm</th> <th>12mm</th> </tr> </thead> <tbody> <tr> <td></td> <td></td> <td></td> <td></td> <td></td> <td></td> <td></td> <td></td> <td></td> <td></td> </tr> </tbody> </table> | 3mm | 4mm | 5mm | 6mm | 7mm | 8mm  | 9mm  | 10mm | 11mm | 12mm |  |  |  |  |  |  |  |  |  |  |
|---------|--|--|-----|-----|-----|-----|-----|------|------|------|------|------|--|--|--|--|--|--|--|--|--|--|
| 3mm     | 4mm  |  | 5mm | 6mm | 7mm | 8mm | 9mm | 10mm | 11mm | 12mm |      |      |  |  |  |  |  |  |  |  |  |  |
|         |  |  |     |     |     |     |     |      |      |      |      |      |  |  |  |  |  |  |  |  |  |  |
| AXI4656 | <b>Anterior Chamber Cannula, 19g</b><br>19 gauge, 4mm from bend to tip. Overall length: 25mm.  |  |     |     |     |     |     |      |      |      |      |      |  |  |  |  |  |  |  |  |  |  |
| AXI4657 | <b>Anterior Chamber Cannula, 19g</b><br>19 gauge, 5mm from bend to tip. Overall length: 25mm.  |  |     |     |     |     |     |      |      |      |      |      |  |  |  |  |  |  |  |  |  |  |
| AXI4658 | <b>Anterior Chamber Cannula, 19g</b><br>19 gauge, 6mm from bend to tip. Overall length: 25mm.  |  |     |     |     |     |     |      |      |      |      |      |  |  |  |  |  |  |  |  |  |  |
| AXI4659 | <b>Anterior Chamber Cannula, 19g</b><br>19 gauge, 7mm from bend to tip. Overall length: 25mm.  |  |     |     |     |     |     |      |      |      |      |      |  |  |  |  |  |  |  |  |  |  |
| AXI4660 | <b>Anterior Chamber Cannula, 19g</b><br>19 gauge, 8mm from bend to tip. Overall length: 25mm.  |  |     |     |     |     |     |      |      |      |      |      |  |  |  |  |  |  |  |  |  |  |
| AXI4661 | <b>Anterior Chamber Cannula, 19g</b><br>19 gauge, 9mm from bend to tip. Overall length: 25mm.  |  |     |     |     |     |     |      |      |      |      |      |  |  |  |  |  |  |  |  |  |  |
| AXI4662 | <b>Anterior Chamber Cannula, 19g</b><br>19 gauge, 10mm from bend to tip. Overall length: 25mm. |  |     |     |     |     |     |      |      |      |      |      |  |  |  |  |  |  |  |  |  |  |
| AXI4663 | <b>Anterior Chamber Cannula, 19g</b><br>19 gauge, 11mm from bend to tip. Overall length: 25mm. |  |     |     |     |     |     |      |      |      |      |      |  |  |  |  |  |  |  |  |  |  |
| AXI4664 | <b>Anterior Chamber Cannula, 19g</b><br>19 gauge, 12mm from bend to tip. Overall length: 25mm. |  |     |     |     |     |     |      |      |      |      |      |  |  |  |  |  |  |  |  |  |  |
| AXI4645 | <b>Anterior Chamber Cannula, 20g</b><br>20 gauge, 3mm from bend to tip. Overall length: 25mm.  |  |     |     |     |     |     |      |      |      |      |      |  |  |  |  |  |  |  |  |  |  |
| AXI4646 | <b>Anterior Chamber Cannula, 20g</b><br>20 gauge, 4mm from bend to tip. Overall length: 25mm.  |  |     |     |     |     |     |      |      |      |      |      |  |  |  |  |  |  |  |  |  |  |
| AXI4647 | <b>Anterior Chamber Cannula, 20g</b><br>20 gauge, 5mm from bend to tip. Overall length: 25mm.  |  |     |     |     |     |     |      |      |      |      |      |  |  |  |  |  |  |  |  |  |  |
| AXI4648 | <b>Anterior Chamber Cannula, 20g</b><br>20 gauge, 6mm from bend to tip. Overall length: 25mm.  |  |     |     |     |     |     |      |      |      |      |      |  |  |  |  |  |  |  |  |  |  |

## ACCUSURGICAL SINGLE-USE CANNULAS &amp; CYSTOTOMES

| Item #    | Description  | Image |
|-----------|--|-------|
| AXI21277B | <b>Anterior Chamber Cannula, 20g</b><br>20 gauge, 7mm from bend to tip. Overall length: 25mm.  |       |
| AXI261    | <b>Anterior Chamber Cannula, 20g</b><br>20 gauge, 8mm from bend to tip. Overall length: 25mm.  |       |
| AXI4651   | <b>Anterior Chamber Cannula, 20g</b><br>20 gauge, 9mm from bend to tip. Overall length: 25mm.  |       |
| AXI4652   | <b>Anterior Chamber Cannula, 20g</b><br>20 gauge, 10mm from bend to tip. Overall length: 25mm. |       |
| AXI4653   | <b>Anterior Chamber Cannula, 20g</b><br>20 gauge, 11mm from bend to tip. Overall length: 25mm. |       |
| AXI4654   | <b>Anterior Chamber Cannula, 20g</b><br>20 gauge, 12mm from bend to tip. Overall length: 25mm. |       |
| AXI4635   | <b>Anterior Chamber Cannula, 21g</b><br>21 gauge, 3mm from bend to tip. Overall length: 22mm.  |       |
| AXI4636   | <b>Anterior Chamber Cannula, 21g</b><br>21 gauge, 4mm from bend to tip. Overall length: 22mm.  |       |
| AXI4637   | <b>Anterior Chamber Cannula, 21g</b><br>21 gauge, 5mm from bend to tip. Overall length: 22mm.  |       |
| AXI4638   | <b>Anterior Chamber Cannula, 21g</b><br>21 gauge, 6mm from bend to tip. Overall length: 22mm.  |       |
| AXI4639   | <b>Anterior Chamber Cannula, 21g</b><br>21 gauge, 7mm from bend to tip. Overall length: 22mm.  |       |
| AXI4640   | <b>Anterior Chamber Cannula, 21g</b><br>21 gauge, 8mm from bend to tip. Overall length: 22mm.  |       |
| AXI4641   | <b>Anterior Chamber Cannula, 21g</b><br>21 gauge, 9mm from bend to tip. Overall length: 22mm.  |       |
| AXI4642   | <b>Anterior Chamber Cannula, 21g</b><br>21 gauge, 10mm from bend to tip. Overall length: 22mm. |       |
| AXI4643   | <b>Anterior Chamber Cannula, 21g</b><br>21 gauge, 11mm from bend to tip. Overall length: 22mm. |       |
| AXI4644   | <b>Anterior Chamber Cannula, 21g</b><br>21 gauge, 12mm from bend to tip. Overall length: 22mm. |       |
| AXI4625   | <b>Anterior Chamber Cannula, 23g</b><br>23 gauge, 3mm from bend to tip. Overall length: 22mm.  |       |
| AXI3254   | <b>Anterior Chamber Cannula, 23g</b><br>23 gauge, 4mm from bend to tip. Overall length: 22mm.  |       |
| AXI4627   | <b>Anterior Chamber Cannula, 23g</b><br>23 gauge, 5mm from bend to tip. Overall length: 22mm.  |       |
| AXI4628   | <b>Anterior Chamber Cannula, 23g</b><br>23 gauge, 6mm from bend to tip. Overall length: 22mm.  |       |
| AXI4629   | <b>Anterior Chamber Cannula, 23g</b><br>23 gauge, 7mm from bend to tip. Overall length: 22mm.  |       |
| AXI4630   | <b>Anterior Chamber Cannula, 23g</b><br>23 gauge, 8mm from bend to tip. Overall length: 22mm.  |       |



## ACCUSURGICAL SINGLE-USE CANNULAS &amp; CYSTOTOMES

| Item #         | Description   | Image |
|----------------|---|-------|
| AXI4631        | <b>Anterior Chamber Cannula, 23g</b><br>23 gauge, 9mm from bend to tip. Overall length: 22mm.                   |       |
| AXI4632        | <b>Anterior Chamber Cannula, 23g</b><br>23 gauge, 10mm from bend to tip. Overall length: 22mm.                  |       |
| AXI4633        | <b>Anterior Chamber Cannula, 23g</b><br>23 gauge, 11mm from bend to tip. Overall length: 22mm.                  |       |
| AXI4634        | <b>Anterior Chamber Cannula, 23g</b><br>23 gauge, 12mm from bend to tip. Overall length: 22mm.                  |       |
| AXI4615        | <b>Anterior Chamber Cannula, 25g</b><br>25 gauge, 3mm from bend to tip. Overall length: 22mm.                   |       |
| AXI21639       | <b>Anterior Chamber Cannula, 25g</b><br>25 gauge, 4mm from bend to tip. Overall length: 22mm.                   |       |
| AXI4617        | <b>Anterior Chamber Cannula, 25g</b><br>25 gauge, 5mm from bend to tip. Overall length: 22mm.                   |       |
| AXI2080        | <b>Anterior Chamber Cannula, 25g</b><br>25 gauge, 6mm from bend to tip. Overall length: 22mm.                   |       |
| AXI4619        | <b>Anterior Chamber Cannula, 25g</b><br>25 gauge, 7mm from bend to tip. Overall length: 22mm.                   |       |
| AXI21638       | <b>Anterior Chamber Cannula, 25g</b><br>25 gauge, 8mm from bend to tip. Overall length: 22mm.                   |       |
| AXI4621        | <b>Anterior Chamber Cannula, 25g</b><br>25 gauge, 9mm from bend to tip. Overall length: 22mm.                   |       |
| AXI21280       | <b>Anterior Chamber Cannula, 25g</b><br>25 gauge, 10mm from bend to tip. Overall length: 22mm.                  |       |
| AXI4623        | <b>Anterior Chamber Cannula, 25g</b><br>25 gauge, 11mm from bend to tip. Overall length: 22mm.                  |       |
| AXI4624        | <b>Anterior Chamber Cannula, 25g</b><br>25 gauge, 12mm from bend to tip. Overall length: 22mm.                  |       |
| AXI4605        | <b>Anterior Chamber Cannula, 27g</b><br>27 gauge, 3mm from bend to tip. Overall length: 22mm.                   |       |
| AXI21273A      | <b>Anterior Chamber Cannula, 27g</b><br>27 gauge, 4mm from bend to tip. Overall length: 22mm.                   |       |
| AXI21273A-BULK | <b>Anterior Chamber Cannula, 27g</b><br>27 gauge, 4mm from bend to tip. Overall length: 22mm. Sold 100 per bag. |       |
| AXI4607        | <b>Anterior Chamber Cannula, 27g</b><br>27 gauge, 5mm from bend to tip. Overall length: 22mm.                   |       |
| AXI21276A      | <b>Anterior Chamber Cannula, 27g</b><br>27 gauge, 6mm from bend to tip. Overall length: 22mm.                   |       |
| AXI1463        | <b>Anterior Chamber Cannula, 27g</b><br>27 gauge, 7mm from bend to tip. Overall length: 22mm.                   |       |
| AXI1956        | <b>Anterior Chamber Cannula, 27g</b><br>27 gauge, 8mm from bend to tip. Overall length: 22mm.                   |       |
| AXI4611        | <b>Anterior Chamber Cannula, 27g</b><br>27 gauge, 9mm from bend to tip. Overall length: 22mm.                   |       |

## ACCUSURGICAL SINGLE-USE CANNULAS &amp; CYSTOTOMES

| Item #        | Description   | Image |
|---------------|---|-------|
| AXI21274      | <b>Anterior Chamber Cannula, 27g</b><br>27 gauge, 10mm from bend to tip. Overall length: 22mm.                  |       |
| AXI4613       | <b>Anterior Chamber Cannula, 27g</b><br>27 gauge, 11mm from bend to tip. Overall length: 22mm.                  |       |
| AXI4614       | <b>Anterior Chamber Cannula, 27g</b><br>27 gauge, 12mm from bend to tip. Overall length: 22mm.                  |       |
| AXI4595       | <b>Anterior Chamber Cannula, 30g</b><br>30 gauge, 3mm from bend to tip. Overall length: 22mm.                   |       |
| AXI21273      | <b>Anterior Chamber Cannula, 30g</b><br>30 gauge, 4mm from bend to tip. Overall length: 22mm.                   |       |
| AXI21273-BULK | <b>Anterior Chamber Cannula, 30g</b><br>30 gauge, 4mm from bend to tip. Overall length: 22mm. Sold 100 per bag. |       |
| AXI4597       | <b>Anterior Chamber Cannula, 30g</b><br>30 gauge, 5mm from bend to tip. Overall length: 22mm.                   |       |
| AXI21276      | <b>Anterior Chamber Cannula, 30g</b><br>30 gauge, 6mm from bend to tip. Overall length: 22mm.                   |       |
| AXI1630       | <b>Anterior Chamber Cannula, 30g</b><br>30 gauge, 7mm from bend to tip. Overall length: 22mm.                   |       |
| AXI21278      | <b>Anterior Chamber Cannula, 30g</b><br>30 gauge, 8mm from bend to tip. Overall length: 22mm.                   |       |
| AXI4601       | <b>Anterior Chamber Cannula, 30g</b><br>30 gauge, 9mm from bend to tip. Overall length: 22mm.                   |       |
| AXI4602       | <b>Anterior Chamber Cannula, 30g</b><br>30 gauge, 10mm from bend to tip. Overall length: 22mm.                  |       |
| AXI4603       | <b>Anterior Chamber Cannula, 30g</b><br>30 gauge, 11mm from bend to tip. Overall length: 22mm.                  |       |
| AXI4604       | <b>Anterior Chamber Cannula, 30g</b><br>30 gauge, 12mm from bend to tip. Overall length: 22mm.                  |       |

## ACCUSURGICAL SINGLE-USE CANNULAS &amp; CYSTOTOMES

| Item # | Description | Image |
|--------|-------------|-------|
|--------|-------------|-------|

**Anterior Chamber Cannula, Straight**

Our single-use Anterior Chamber Cannula, also known as Air Injection, Rycroft, and Viscoelastic cannula, is available from 19 to 30 gauge. Every cannula has a straight shaft with a blunt tip. Overall length ranges from 22mm to 32mm. Sold 10 per box.

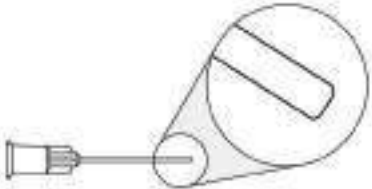
|         |   |  |
|---------|---|--|
| AXI4678 | <b>Anterior Chamber Cannula, 19g</b><br>19 gauge. Overall length: 25mm. |  |
|---------|---|--|

|         |   |
|---------|---|
| AXI4676 | <b>Anterior Chamber Cannula, 20g</b><br>20 gauge. Overall length: 25mm. |
|---------|---|

|         |   |
|---------|---|
| AXI4674 | <b>Anterior Chamber Cannula, 21g</b><br>21 gauge. Overall length: 22mm. |
|---------|---|

|         |   |
|---------|---|
| AXI4671 | <b>Anterior Chamber Cannula, 23g</b><br>23 gauge. Overall length: 22mm. |
|---------|---|

|         |   |
|---------|---|
| AXI4672 | <b>Anterior Chamber Cannula, 23g</b><br>23 gauge. Overall length: 32mm. |
|---------|---|

|         |   |
|---------|---|
| AXI4669 | <b>Anterior Chamber Cannula, 25g</b><br>25 gauge. Overall length: 22mm. |
|---------|---|

|         |   |
|---------|---|
| AXI4667 | <b>Anterior Chamber Cannula, 27g</b><br>27 gauge. Overall length: 22mm. |
|---------|---|

|         |   |
|---------|---|
| AXI4665 | <b>Anterior Chamber Cannula, 30g</b><br>30 gauge. Overall length: 22mm. |
|---------|---|

**Anterior Chamber Cannula, Curved**

Our single-use Anterior Chamber Cannula, also known as Air Injection, Rycroft, and Viscoelastic cannula, is available from 19 to 30 gauge. Every cannula has a curved shaft with a blunt tip. Overall length ranges from 22mm to 25mm. Sold 10 per box.

|         |   |  |
|---------|---|--|
| AXI4679 | <b>Anterior Chamber Cannula, 19g</b><br>19 gauge. Overall length: 25mm. |  |
|---------|---|--|

|         |   |
|---------|---|
| AXI4677 | <b>Anterior Chamber Cannula, 20g</b><br>20 gauge. Overall length: 25mm. |
|---------|---|

|         |   |
|---------|---|
| AXI4675 | <b>Anterior Chamber Cannula, 21g</b><br>21 gauge. Overall length: 22mm. |
|---------|---|

|         |   |
|---------|---|
| AXI4673 | <b>Anterior Chamber Cannula, 23g</b><br>23 gauge. Overall length: 22mm. |
|---------|---|

|         |   |
|---------|---|
| AXI4670 | <b>Anterior Chamber Cannula, 25g</b><br>25 gauge. Overall length: 22mm. |
|---------|---|

|         |   |
|---------|---|
| AXI4668 | <b>Anterior Chamber Cannula, 27g</b><br>27 gauge. Overall length: 22mm. |
|---------|---|

|         |  |
|---------|--|
| AXI4666 | <b>Anterior Chamber Cannula 30g</b><br>30 gauge. Overall length: 22mm. |
|---------|--|

ACCUSURGICAL SINGLE-USE CANNULAS & CYSTOTOMES

**Item #**                      **Description**    **Image**

**Air Injection Cannula**

26 gauge, angled shaft, 10mm from bend to tip, blunt tip. Disposable, sold 10 per box.

AXI21277                      **Air Injection Cannula, 26g**

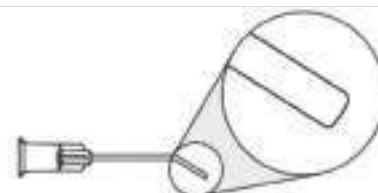

**Viscoelastic Cannula**

Disposable Viscoelastic Cannulas are 27 gauge with the option of an angled or formed shaft. They are 11mm from bend to tip and have blunt tips. Overall length: 22mm. Sold 10 per box.

AXI21279A                      **Angled Viscoelastic Cannula**  
Angled shaft.

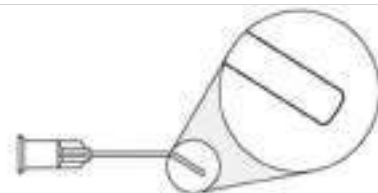

AXI4680                      **Formed Viscoelastic Cannula**  
Formed shaft.



**Thin Wall Anterior Chamber Cannula, Angled**

A thin wall cannula allows the advantage of a larger bore through a smaller cannula. The inside diameter is approximately 2 gauge sizes larger, therefore, a 25 gauge thin wall lumen is approximately the same as the inside lumen on a 23 gauge. Thin Wall Anterior Chamber Cannulas are disposable and have angled shafts and blunt tips. Overall length: 22mm. Sold 10 per box.

AXI4691                      **Thin Wall Cannula, 23g**  
23 gauge thin wall, 3mm from bend to tip.

AXI4692                      **Thin Wall Cannula, 23g**  
23 gauge thin wall, 4mm from bend to tip.

AXI4693                      **Thin Wall Cannula, 23g**  
23 gauge thin wall, 5mm from bend to tip.

AXI4694                      **Thin Wall Cannula, 23g**  
23 gauge thin wall, 6mm from bend to tip.

AXI4695                      **Thin Wall Cannula, 23g**  
23 gauge thin wall, 7mm from bend to tip.

AXI4696                      **Thin Wall Cannula, 23g**  
23 gauge thin wall, 8mm from bend to tip.

AXI4697                      **Thin Wall Cannula, 23g**  
23 gauge thin wall, 9mm from bend to tip.

AXI4698                      **Thin Wall Cannula, 23g**  
23 gauge thin wall, 10mm from bend to tip.

AXI4699                      **Thin Wall Cannula, 23g**  
23 gauge thin wall, 11mm from bend to tip.

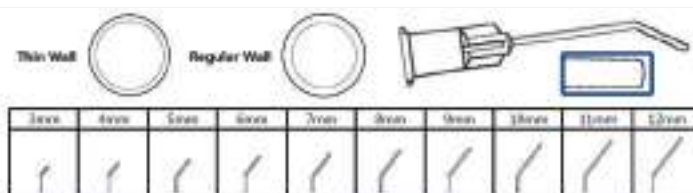

## ACCUSURGICAL SINGLE-USE CANNULAS &amp; CYSTOTOMES

| Item #  | Description   | Image |
|---------|---|-------|
| AXI4700 | <b>Thin Wall Cannula, 23g</b><br>23 gauge thin wall, 12mm from bend to tip. |       |
| AXI4681 | <b>Thin Wall Cannula, 25g</b><br>25 gauge thin wall, 3mm from bend to tip.  |       |
| AXI4682 | <b>Thin Wall Cannula, 25g</b><br>25 gauge thin wall, 4mm from bend to tip.  |       |
| AXI4683 | <b>Thin Wall Cannula, 25g</b><br>25 gauge thin wall, 5mm from bend to tip.  |       |
| AXI4684 | <b>Thin Wall Cannula, 25g</b><br>25 gauge thin wall, 6mm from bend to tip.  |       |
| AXI4685 | <b>Thin Wall Cannula, 25g</b><br>25 gauge thin wall, 7mm from bend to tip.  |       |
| AXI4686 | <b>Thin Wall Cannula, 25g</b><br>25 gauge thin wall, 8mm from bend to tip.  |       |
| AXI4687 | <b>Thin Wall Cannula, 25g</b><br>25 gauge thin wall, 9mm from bend to tip.  |       |
| AXI4688 | <b>Thin Wall Cannula, 25g</b><br>25 gauge thin wall, 10mm from bend to tip. |       |
| AXI4689 | <b>Thin Wall Cannula, 25g</b><br>25 gauge thin wall, 11mm from bend to tip. |       |
| AXI4690 | <b>Thin Wall Cannula, 25g</b><br>25 gauge thin wall, 12mm from bend to tip. |       |

**Thin Wall Anterior Chamber Cannula, Curved**

A thin wall cannula allows the advantage of a larger bore through a smaller cannula. The inside diameter is approximately 2 gauge sizes larger, therefore, a 25 gauge thin wall lumen is approximately the same as the inside lumen on a 23 gauge. Thin Wall Anterior Chamber Cannulas are disposable and have curved shafts and blunt tips. Overall length: 22mm. Sold 10 per box.

|         |   |
|---------|---|
| AXI4704 | <b>Anterior Chamber Cannula, 23g</b><br>23 gauge thin wall. |
| AXI4702 | <b>Anterior Chamber Cannula, 25g</b><br>25 gauge thin wall. |

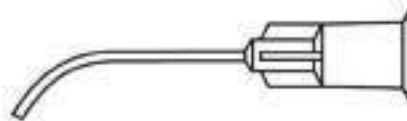
**Thin Wall Anterior Chamber Cannula, Straight**

A thin wall cannula allows the advantage of a larger bore through a smaller cannula. The inside diameter is approximately 2 gauge sizes larger, therefore, a 25 gauge thin wall lumen is approximately the same as the inside lumen on a 23 gauge. Thin Wall Anterior Chamber Cannulas are disposable and have straight shafts and blunt tips. Overall length: 22mm. Sold 10 per box.

|         |   |
|---------|---|
| AXI4703 | <b>Anterior Chamber Cannula, 23g</b><br>23 gauge thin wall. |
| AXI4701 | <b>Anterior Chamber Cannula, 25g</b><br>25 gauge thin wall. |

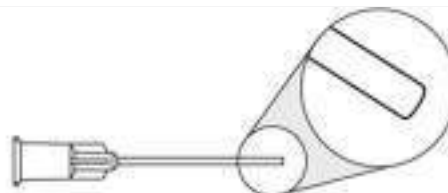

ACCUSURGICAL SINGLE-USE CANNULAS & CYSTOTOMES

| Item # | Description | Image |
|--------|-------------|-------|
|--------|-------------|-------|

**Double I/A Cannula**

Double Irrigating and Aspirating Cannulas are part of our disposable line. Each cannula has a straight shaft and are available in various gauges and tip types. Sold 10 per box.

|         |  |
|---------|--|
| AXI4705 | <b>Double I/A Cannula Sideport</b><br>21 gauge, one rounded closed 0.3mm sideport tip, one open tip. |
|---------|--|

|         |   |
|---------|---|
| AXI4707 | <b>Double I/A Cannula Open End</b><br>21 gauge, both tips are open ended. |
|---------|---|

|         |   |
|---------|---|
| AXI4708 | <b>Double I/A Cannula Open End</b><br>21 gauge, 19 gauge, both tips are open ended. |
|---------|---|

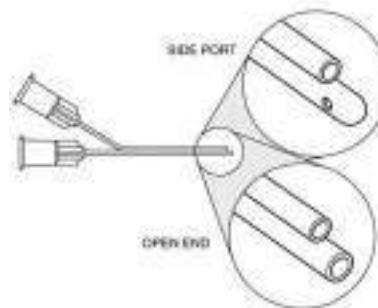

**J-Shaped Double I/A Cannula**

23 gauge and 25 gauge, straight shaft, open ended top tip, J-shaped bottom tip with 0.2mm sideport. Disposable, sold 10 per box.

|         |                                    |
|---------|------------------------------------|
| AXI4706 | <b>J-Shaped Double I/A Cannula</b> |
|---------|------------------------------------|



**Double Barrel I/A Cannula [Simcoe]**

Disposable Double Barrel Irrigating and Aspirating Cannulas are 23 gauge with curved shafts. They have rounded closed tips with 0.3mm sideport on the top or bottom and an open-ended slanted tip. Each cannula comes with 6" silicone tubing and measures 16mm in overall length. Sold 10 per box.

|         |   |
|---------|---|
| AXI4710 | <b>Double Barrel I/A Cannula, Reverse</b><br>Sideport on bottom, open-ended slanted tip on top. |
|---------|---|

|          |  |
|----------|--|
| AXI61571 | <b>Double Barrel I/A Cannula, Standard</b><br>Sideport on top, open-ended slanted tip on bottom. |
|----------|--|

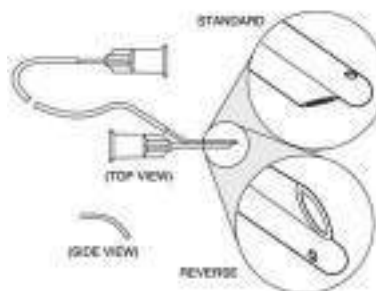

**Cortex Extractor [Charleux]**

23 gauge, curved shaft, open pointed tip. Overall length: 13mm. Disposable, sold 10 per box.

|         |                              |
|---------|------------------------------|
| AXI4713 | <b>Cortex Extractor, 23g</b> |
|---------|------------------------------|



ACCUSURGICAL SINGLE-USE CANNULAS & CYSTOTOMES

| Item # | Description | Image |
|--------|-------------|-------|
|--------|-------------|-------|

**Cortex Extractor [Simcoe]**

Disposable Simcoe Cortex Extractor Cannulas are 23 gauge with curved shafts and rounded closed tips with 0.3mm sideport. Various lengths are available. Sold 10 per box.

AXI4711 **Cortex Extractor, 23g**  
Overall length: 13mm.

AXI55075 **Cortex Extractor, 23g**  
Overall length: 22mm.



**Button Coaxial I/A System**

Disposable Button Coaxial Irrigating and Aspirating Systems have a 17 gauge thin wall outer cannula and a 21 gauge inner cannula. Straight shafts with closed, rounded tip and 0.3mm sideport. Overall length: 30mm. Sold 10 per box.

AXI4714 **Button Coaxial I/A System, Angled**  
30-degree angled tip.

AXI4715 **Button Coaxial I/A System, Straight**  
Straight tip.

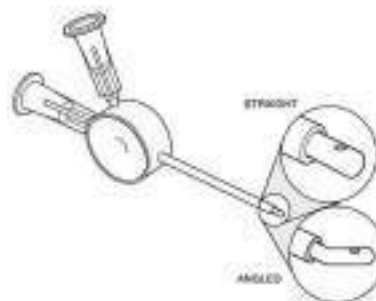

**J-Shaped Cannula**

Disposable J-shaped tip cannulas with both straight and angled shafts. Available in sizes from 21 gauge to 30 gauge and various sized tips. Overall length: 22mm. Sold 10 per box, unless specified otherwise.

AXI4725 **J-Shaped Cannula, 21g**  
21 gauge, straight shaft, 2mm high x 2mm wide tip.

AXI4723 **J-Shaped Cannula, 23g**  
23 gauge, straight shaft, 2mm high x 2mm wide tip.

AXI4724 **J-Shaped Cannula, 23g**  
23 gauge, 45 degree angled shaft, 10mm from bend to tip, 2mm high x 2mm wide tip.

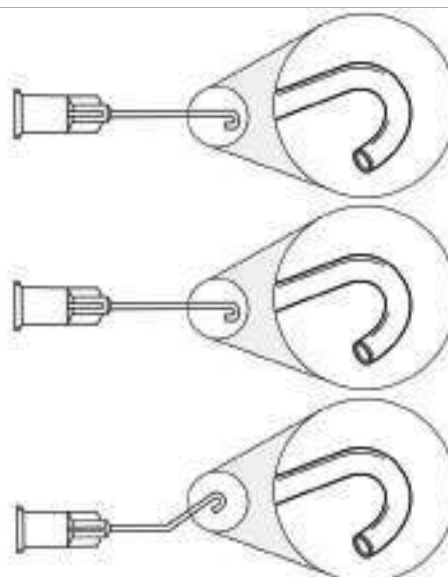

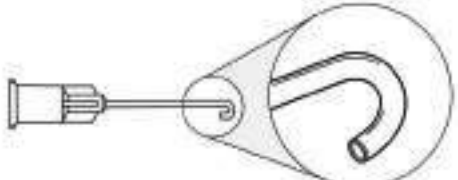
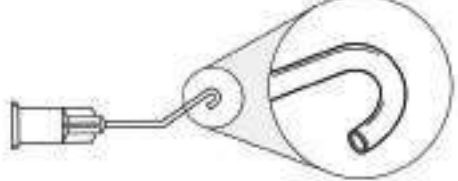
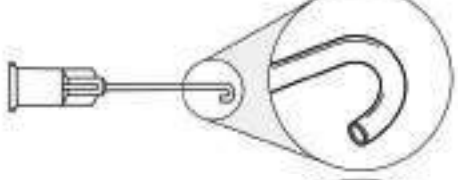
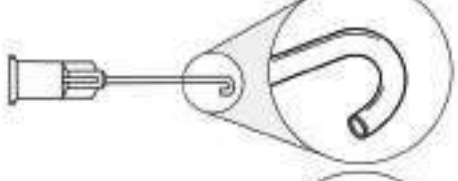
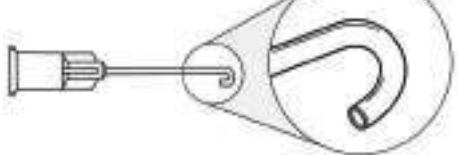

ACCUSURGICAL SINGLE-USE CANNULAS & CYSTOTOMES

| Item #        | Description   | Image  |
|---------------|---|--|
| AXI0761       | <b>J-Shaped Cannula, 25g</b><br>25 gauge, straight shaft, 1.5mm high x 1.5mm wide tip.                            |    |
| AXI4719       | <b>J-Shaped Cannula, 25g</b><br>25 gauge, 45 degree angled shaft, 10mm from bend to tip, 2mm high x 2mm wide tip. |    |
| AXI51297      | <b>J-Shaped Cannula, 27g</b><br>27 gauge, straight shaft, 1.5mm high x 1.5mm wide tip.                            |    |
| AXI51297-BULK | <b>J-Shaped Cannula, 27g</b><br>27 gauge, straight shaft, 1.5mm high x 1.5mm wide tip. Sold 100 per bag.          |   |
| AXI51287      | <b>J-Shaped Cannula, 30g</b><br>30 gauge, straight shaft, 1.5mm high x 1.5mm wide tip.                            |  |

**J-Shaped Cannula [Binkhorst]**

The J-Shaped Binkhorst Cannula is available for left or right hand usage. Both choices are 25 gauge with 18 degree angled shaft, 12mm from bend to tip. A J-shaped tip that measures 1.5mm high x 1.75mm wide. Overall length: 22mm. Sold 10 per box.

|         |  |  |
|---------|--|--|
| AXI4720 | <b>J-Shaped Cannula, 25g, Left</b><br>Angled left shaft.   |  |
| AXI4721 | <b>J-shaped Cannula, 25g, Right</b><br>Angled right shaft. |  |

**Micro J-Shaped Cannula [Hessburg]**

25 gauge, straight shaft, J-shaped tip, 0.85mm long x 1.7mm wide. Overall length: 22mm. Disposable, sold 10 per box.

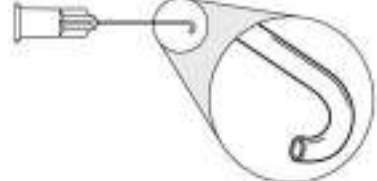
|         |                               |  |
|---------|-------------------------------|--|
| AXI4722 | <b>Micro J-Shaped Cannula</b> |  |
|---------|-------------------------------|--|

ACCUSURGICAL SINGLE-USE CANNULAS & CYSTOTOMES

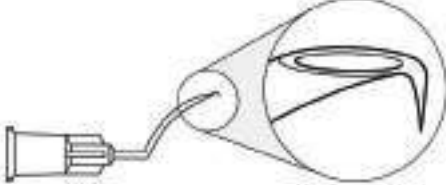
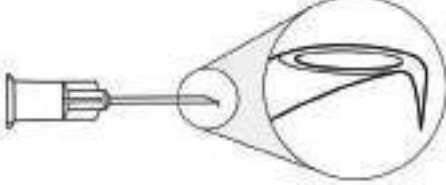
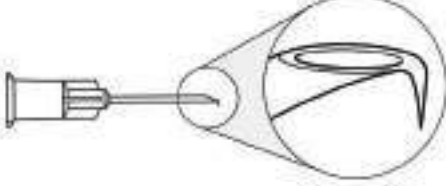
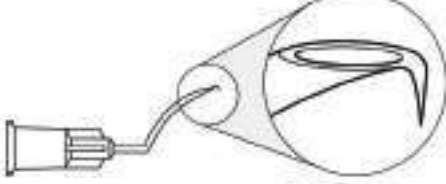
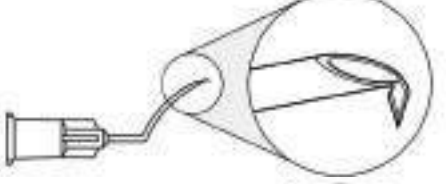
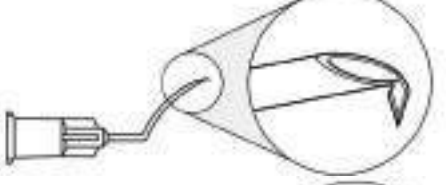
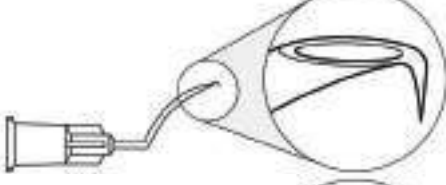
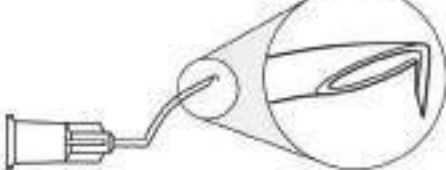
| Item #  | Description  | Image  |
|---|--|--|
| <b>Irrigating Cystotome</b>   |  |  |
| Disposable Irrigating Cystotomes and Capsulorhexis Cystotomes with various shaft and tip styles. Each cystotome has a bent, pointed tip and is available in 23 to 30 gauge in size. Ranges in gauge and shaft styles. Overall length ranges from 16mm to 22mm. Sold 10 per box, unless specified otherwise. |  |  |
| AXI31599  | <p data-bbox="261 449 493 470"><b>Irrigating Cystotome, 23g</b></p> <p data-bbox="261 485 659 506">23 gauge, formed shaft. Overall length: 16mm.</p>   |    |
| AXI4731   | <p data-bbox="261 642 493 663"><b>Irrigating Cystotome, 23g</b></p> <p data-bbox="261 678 659 699">23 gauge, straight shaft. Overall length: 16mm.</p>   |    |
| AXI4732   | <p data-bbox="261 835 493 856"><b>Irrigating Cystotome, 23g</b></p> <p data-bbox="261 871 659 892">23 gauge, straight shaft. Overall length: 19mm.</p>   |   |
| AXI4739   | <p data-bbox="261 1029 493 1050"><b>Irrigating Cystotome, 23g</b></p> <p data-bbox="261 1064 659 1085">23 gauge, formed shaft. Overall length: 19mm.</p>   |  |
| AXI4752   | <p data-bbox="261 1222 537 1243"><b>Capsulorhexis Cystotome, 23g</b></p> <p data-bbox="261 1257 786 1299">23 gauge, formed shaft with pointed tips that are twisted 90 degrees. Overall length: 16mm.</p>    |  |
| AXI4753   | <p data-bbox="261 1415 537 1436"><b>Capsulorhexis Cystotome, 23g</b></p> <p data-bbox="261 1451 786 1493">23 gauge, straight shaft with pointed tips that are twisted 90 degrees. Overall length: 16mm.</p>  |  |
| AXII348   | <p data-bbox="261 1608 493 1629"><b>Irrigating Cystotome, 25g</b></p> <p data-bbox="261 1644 659 1665">25 gauge, formed shaft. Overall length: 16mm.</p>   |  |
| AXII891   | <p data-bbox="261 1801 493 1822"><b>Irrigating Cystotome, 25g</b></p> <p data-bbox="261 1837 732 1879">25 gauge, formed shaft, reverse formed, tip angled 90 degrees toward bevel. Overall length: 16mm.</p> |  |

ACCUSURGICAL SINGLE-USE CANNULAS & CYSTOTOMES

| Item #        | Description  | Image |
|---------------|--|-------|
| AXI31610A     | <p><b>Irrigating Cystotome, 25g</b><br/>                     25 gauge, straight shaft. Overall length: 16mm.</p>                 |       |
| AXI31610      | <p><b>Irrigating Cystotome, 25g</b><br/>                     25 gauge, formed shaft. Overall length: 16mm.</p>                   |       |
| AXI31610-BULK | <p><b>Irrigating Cystotome, 25g</b><br/>                     25 gauge, formed shaft. Overall length: 16mm. Sold 100 per bog.</p> |       |
| AXI35004      | <p><b>Irrigating Cystotome, 25g</b><br/>                     25 gauge, formed shaft, small radius tip. Overall length: 16mm.</p> |       |
| AXI35049      | <p><b>Irrigating Cystotome, 25g</b><br/>                     25 gauge, angled shaft. Overall length: 16mm.</p>                   |       |
| AXI4743       | <p><b>Irrigating Cystotome [Joyce], 25g</b><br/>                     25 gauge, curved shaft. Overall length: 16mm.</p>           |       |
| AXI4736       | <p><b>Irrigating Cystotome, 25g</b><br/>                     25 gauge, formed shaft. Overall length: 16mm.</p>                   |       |
| AXI4737       | <p><b>Irrigating Cystotome, 25g</b><br/>                     25 gauge, formed shaft. Overall length: 22mm.</p>                   |       |

ACCUSURGICAL SINGLE-USE CANNULAS & CYSTOTOMES

| Item #   | Description  | Image |
|----------|--|-------|
| AXI4730  | <p><b>Irrigating Cystotome, 25g</b><br/>25 gauge, straight shaft. Overall length: 22mm.</p>  |       |
| AXI35113 | <p><b>Capsulorhexis Cystotome, 25g</b><br/>25 gauge, formed shaft with pointed tips that are twisted 90 degrees. Overall length: 16mm.</p>   |       |
| AXI4751  | <p><b>Capsulorhexis Cystotome, 25g</b><br/>25 gauge, straight shaft with pointed tips that are twisted 90 degrees. Overall length: 16mm.</p> |       |
| AXI4742  | <p><b>Irrigating Cystotome [Joyce], 27g</b><br/>27 gauge, curved shaft. Overall length: 16mm.</p>  |       |
| AXI31618 | <p><b>Irrigating Cystotome, 27g</b><br/>27 gauge, formed shaft. Overall length: 16mm.</p>  |       |
| AXI35093 | <p><b>Irrigating Cystotome, 27g</b><br/>27 gauge, angled shaft. Overall length: 16mm.</p>  |       |
| AXI4727  | <p><b>Irrigating Cystotome, 27g</b><br/>27 gauge, straight shaft. Overall length: 16mm.</p>  |       |
| AXI4745  | <p><b>Irrigating Cystotome, 27g</b><br/>27 gauge, formed shaft, small radius tip. Overall length: 16mm.</p>                                  |       |

ACCUSURGICAL SINGLE-USE CANNULAS & CYSTOTOMES

| Item #   | Description   | Image |
|----------|---|-------|
| AXI4728  | <p><b>Irrigating Cystotome, 27g</b><br/>                     27 gauge, straight shaft. Overall length: 19mm.</p>  |       |
| AXI4735  | <p><b>Irrigating Cystotome, 27g</b><br/>                     27 gauge, formed shaft. Overall length: 19mm.</p>  |       |
| AXI35042 | <p><b>Capsulorhexis Cystotome, 27g</b><br/>                     27 gauge, formed shaft with pointed tips that are twisted 90 degrees. Overall length: 16mm.</p>   |       |
| AXI4749  | <p><b>Capsulorhexis Cystotome, 27g</b><br/>                     27 gauge, straight shaft with pointed tips that are twisted 90 degrees. Overall length: 16mm.</p> |       |
| AXI4726  | <p><b>Irrigating Cystotome, 30g</b><br/>                     30 gauge, straight shaft. Overall length: 16mm.</p>  |       |

**Irrigating Double Sharp Cystotome [Kelman]**

22 gauge, straight shaft, bent, pointed tip. Overall length: 25mm. Disposable, sold 10 per box.

|         |  |  |
|---------|--|--|
| AXI4755 | <p><b>Irrigating Double Sharp Cystotome, 22g</b></p> |  |
|---------|--|--|

ACCUSURGICAL SINGLE-USE CANNULAS & CYSTOTOMES

| Item # | Description | Image |
|--------|-------------|-------|
|--------|-------------|-------|

**Irrigating Sharp Cystotome [Kelman]**

22 gauge, straight shaft, bent, pointed tip. Overall length: 25mm. Disposable, sold 10 per box.

AXI4754 **Irrigating Sharp Cystotome, 22g**



**Capsule Polisher**

Single-use Capsule Polisher cannula available in 21 gauge or 23 gauge sizes with a 37 degree angled shaft. Angled shaft is 7mm from bend to tip and has various types of 3mm sandblasted tips. Overall length: 22mm. Sold 10 per box.

AXI4756 **Capsule Polisher, 21g**  
21 gauge, 3mm sandblasted closed distal tip with 0.3mm sideport.

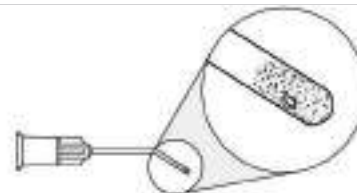

AXI4758 **Capsule Polisher, 21g**  
21 gauge, 3mm sandblasted distal end tip, open ended.

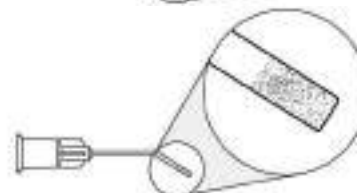

AXI4757 **Capsule Polisher, 23g**  
23 gauge, 3mm sandblasted closed distal tip with 0.3mm sideport.

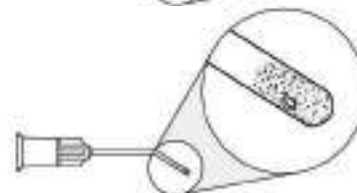

AXI4759 **Capsule Polisher, 23g**  
23 gauge, 3mm sandblasted distal end tip, open ended.

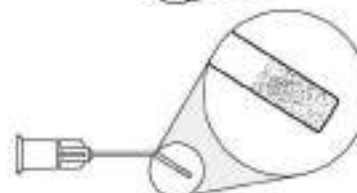

**Posterior Capsule Polisher**

23 gauge, 45-degree angled shaft, 12mm from bend to tip, 2mm sandblasted distal end, angled 90 degrees. Overall length: 22mm. Disposable, sold 10 per box.

AXI4760 **Posterior Capsule Polisher, 23g**

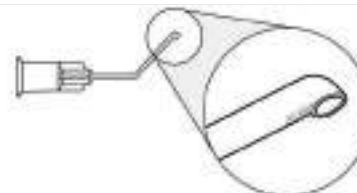

ACCUSURGICAL SINGLE-USE CANNULAS & CYSTOTOMES

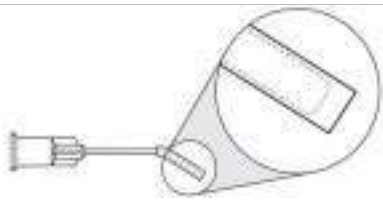
| Item #   | Description   | Image  |
|--|---|--|
| <b>Silicone Tip Capsule Polisher</b>   |   |  |
| Disposable Silicone Tip Capsule Polisher cannula with 32-degree angled shafts. Cannulas come with various lengths of squeegee, silicone tubing. Overall length: 22mm. Sold 10 per box. |   |  |
| AXI75041   | <b>Capsule Polisher, 23g</b><br>23 gauge, 7mm from bend to tip, 10mm silicone tubing. |  |
| AXI4763  | <b>Capsule Polisher, 23g</b><br>23 gauge, 9mm from bend to tip, 12mm silicone tubing. |  |
| AXI75005   | <b>Capsule Polisher, 27g</b><br>27 gauge, 7mm from bend to tip, 10mm silicone tubing. |  |

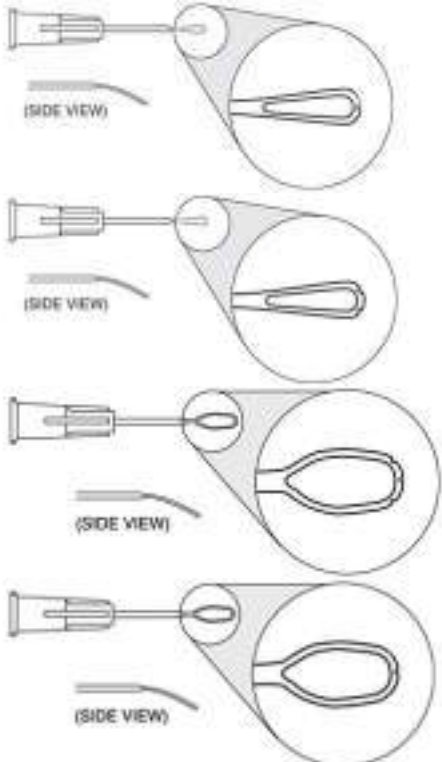
|  |  |   |
|--|--|---|
| <b>Irrigating Vectis</b>   |  |   |
| 24 gauge Irrigating Vectis cannula is part of the AccuSurgical Single Use line. Each cannula has a straight shaft with a curved looped tip and one to three ports. Tips are available in 3mm to 5mm widths. Sold 10 per box. |  |   |
| AXI4765  | <b>Irrigating Vectis, 3mm</b><br>Curved 3mm loop tip, one 0.3mm port.    |  |
| AXI4766  | <b>Irrigating Vectis, 4mm</b><br>Curved 4mm loop tip, two 0.3mm ports.   |   |
| AXI4767  | <b>Irrigating Vectis, 5mm</b><br>Curved 5mm loop tip, three 0.3mm ports. |   |
| AXI4764  | <b>Irrigating Vectis, 5mm</b><br>Curved 5mm loop tip, one 0.3mm port.    |   |

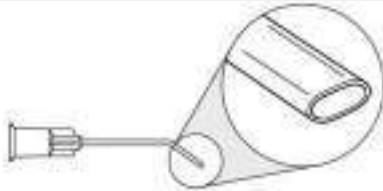
|  |   |  |
|--|---|--|
| <b>Bishop-Harmon Washout Cannula</b>   |   |  |
| Disposable 19 gauge Bishop-Harmon Washout Cannulas with 37-degree angled shafts and smooth oval shaped tips. Overall length: 25mm. Sold 10 per box unless specified otherwise. |   |  |
| AXI65041   | <b>Washout Cannula, 19g</b><br>19 gauge, 37-degree angled shaft, 5mm from bend to tip.                      |  |
| AXI65040   | <b>Washout Cannula, 19g</b><br>19 gauge, 37-degree angled shaft, 8mm from bend to tip.                      |  |
| AXI65040-BULK  | <b>Washout Cannula, 19g</b><br>19 gauge, 37-degree angled shaft, 8mm from bend to tip.<br>Sold 100 per bag. |  |



## ACCUSURGICAL SINGLE-USE CANNULAS &amp; CYSTOTOMES

| Item # | Description | Image |
|--------|-------------|-------|
|--------|-------------|-------|

**Nucleus Hydrodissection Cannula**

Disposable Nucleus Hydrodissection Cannula with 32-degree angled shaft, 8mm from bend to tip. Cannulas are available in 23 gauge to 30 gauge sizes with flattened, smooth, oval-shaped tip. Overall length: 22mm. Sold 10 per box, unless specified otherwise.

|         |   |  |
|---------|---|--|
| AXI4772 | <b>Nucleus Hydrodissection Cannula, 23g</b> |  |
|---------|---|--|

23 gauge.

|          |   |
|----------|---|
| AXI25037 | <b>Nucleus Hydrodissection Cannula, 25g</b> |
|----------|---|

25 gauge.

|               |   |
|---------------|---|
| AXI25037-BULK | <b>Nucleus Hydrodissection Cannula, 25g</b> |
|---------------|---|

25 gauge. Sold 100 per bag.

|          |   |
|----------|---|
| AXI25158 | <b>Nucleus Hydrodissection Cannula, 27g</b> |
|----------|---|

27 gauge.

|         |   |
|---------|---|
| AXI3014 | <b>Nucleus Hydrodissection Cannula, 30g</b> |
|---------|---|

30 gauge.

**Hydrodissection Cannula [Chang]**

27 gauge, straight shaft, flattened tip. Overall length: 22mm. Disposable, sold 10 per box.

|         |                                |   |
|---------|--------------------------------|---|
| AXI4784 | <b>Hydrodissection Cannula</b> |  |
|---------|--------------------------------|---|

**Hydrodissection Cannula [Kellan]**

Kellan Hydrodissection Cannulas are part of the AccuSurgical Single Use product line. These cannulas are available in 25 gauge or 27 gauge with curved shafts and blunt, oval-shaped tips. Overall length: 22mm. Sold 10 per box.

|         |                                     |  |
|---------|-------------------------------------|--|
| AXI4778 | <b>Hydrodissection Cannula, 25g</b> |  |
|---------|-------------------------------------|--|

25 gauge.

|           |                                     |
|-----------|-------------------------------------|
| AXI21273D | <b>Hydrodissection Cannula, 27g</b> |
|-----------|-------------------------------------|

27 gauge.

ACCUSURGICAL SINGLE-USE CANNULAS & CYSTOTOMES

| Item # | Description | Image |
|--------|-------------|-------|
|--------|-------------|-------|

**J-Shaped Hydrodissection Cannula**

Disposable J-Shaped Hydrodissection Cannulas range in size from 25 gauge to 30 gauge. Each cannula has a straight shaft with a smooth oval and J-shaped tip that is available in different widths. Overall length: 22mm. Sold 10 per box.

|          |   |
|----------|---|
| AXI4775  | <b>J-Shaped Hydrodissection Cannula, 25g</b><br>25 gauge, 1.5mm high x 2mm wide tip.    |
| AXI25029 | <b>J-Shaped Hydrodissection Cannula, 27g</b><br>27 gauge, 1.5mm high x 1.75mm wide tip. |
| AXI4773  | <b>J-Shaped Hydrodissection Cannula, 30g</b><br>30 gauge, 1.5mm high x 1.5mm wide tip.  |

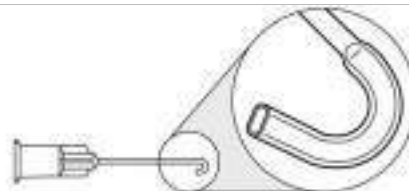

**Hydrodelineation Needle [Kellan]**

Disposable Kellan Hydrodelineation Needles are available in 25 gauge or 27 gauge sizes. Each one has a curved shaft with a shortened bevel, needle tip. Overall length: 22mm. Sold 10 per box.

|         |  |
|---------|--|
| AXI4776 | <b>Hydrodelineation Needle, 25g</b><br>25 gauge. |
| AXI4777 | <b>Hydrodelineation Needle, 27g</b><br>27 gauge. |

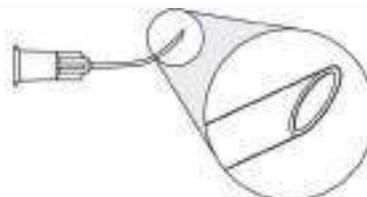

**Nucleus Hydrolysis Needle [P. Koch]**

25 gauge, curved shaft, flattened, oval-shaped tip. Overall length: 22mm. Disposable, sold 10 per box.

|         |                                       |
|---------|---------------------------------------|
| AXI4780 | <b>Nucleus Hydrolysis Needle, 25g</b> |
|---------|---------------------------------------|

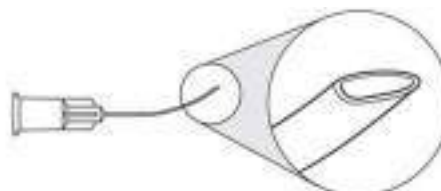

**Nucleus Hydrodissector/Rotator [Sinskey]**

25 gauge, 32-degree angled shaft, 8mm from bend to tip, forked blunt tip. Overall length: 22mm. Disposable, sold 10 per box.

|         |                                       |
|---------|---------------------------------------|
| AXI4781 | <b>Nucleus Hydrodissector/Rotator</b> |
|---------|---------------------------------------|

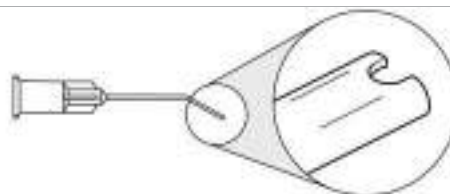

**Cotrical Cleaving Hydrodissector**

27 gauge, angled shaft, 11mm from bend to tip, horizontally flattened tip, flattened 4mm from tip. Overall length: 22mm. Disposable, sold 10 per box.

|          |  |
|----------|--|
| AXI25157 | <b>Cotrical Cleaving Hydrodissector, 27g</b> |
|----------|--|

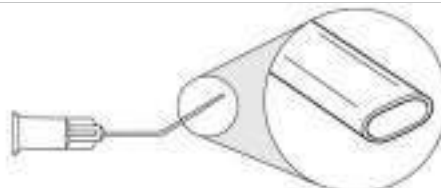

ACCUSURGICAL SINGLE-USE CANNULAS & CYSTOTOMES

| Item # | Description | Image |
|--------|-------------|-------|
|--------|-------------|-------|

**Nucleus Hydrodissector**

27 gauge, curved shaft, tip flattened horizontally 4mm from end. Overall length: 22mm. Disposable, sold 10 per box.

|          |                                    |  |
|----------|------------------------------------|--|
| AXI25155 | <b>Nucleus Hydrodissector, 27g</b> |  |
|----------|------------------------------------|--|

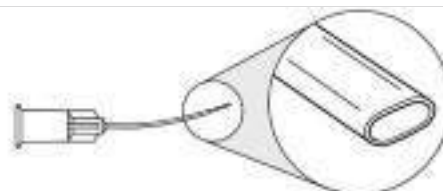

**Lacrimal Cannula**

Disposable Lacrimal Cannulas are available with either straight or curved shafts. Sizes range from 19 gauge to 26 gauge. Sold 10 per box.

|         |   |  |
|---------|---|--|
| AXI4786 | <b>Lacrimal Cannula Straight, 19g</b><br>19 gauge tapered to 23 gauge, straight shaft, tapered 12mm from tip. Overall length: 38mm. |  |
|---------|---|--|

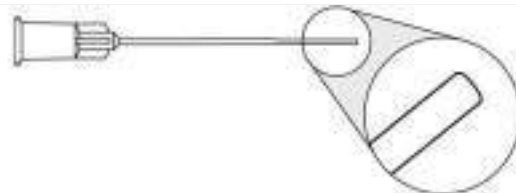

|         |   |  |
|---------|---|--|
| AXI4785 | <b>Lacrimal Cannula Curved, 25g</b><br>25 gauge, slightly curved shaft, tumble polished edge. Overall length: 28mm. |  |
|---------|---|--|

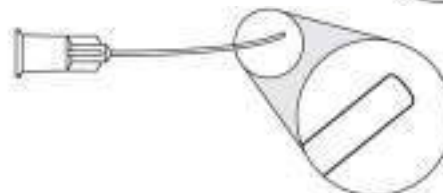

|         |  |  |
|---------|--|--|
| AXI0649 | <b>Lacrimal Cannula Curved, 26g</b><br>26 gauge, curved shaft, open tip. Overall length: 28mm. |  |
|---------|--|--|

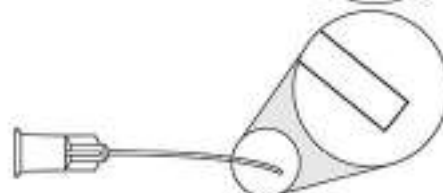

**Irrigating Dialer**

30 gauge, 45-degree angled shaft, 10mm from bend to tip, 1mm distal end angled 65 degrees. Overall length: 22mm. Disposable, sold 10 per box.

|         |                          |  |
|---------|--------------------------|--|
| AXI4802 | <b>Irrigating Dialer</b> |  |
|---------|--------------------------|--|

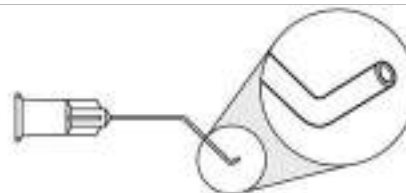

**Alpha-Chymotrypsin Cannula**

25 gauge, curved shaft, 1mm smooth, bulbous tip. Overall length: 28mm. Disposable, sold 10 per box.

|         |                                   |  |
|---------|-----------------------------------|--|
| AXI4808 | <b>Alpha-Chymotrypsin Cannula</b> |  |
|---------|-----------------------------------|--|

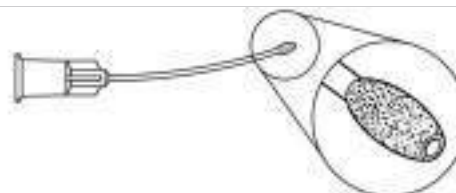

ACCUSURGICAL SINGLE-USE CANNULAS & CYSTOTOMES

| Item # | Description | Image |
|--------|-------------|-------|
|--------|-------------|-------|

**Olive Tip Capsule Polisher**

Disposable Olive Tip Cannulas range from 23 gauge to 25 gauge in size and are available with angled or curved shafts. Each cannula has a 1mm sandblasted or smooth bulbous tip. Sold 10 per box.

AXI4810 **Olive Tip Capsule Polisher, 23g**  
23 gauge, curved shaft. Smooth tip. Overall length: 22mm.

AXI4812 **Olive Tip Capsule Polisher, 23g**  
23 gauge, angled shaft, 10mm from bend to tip. Sandblasted tip. Overall length: 22mm.

AXI4811 **Olive Tip Capsule Polisher, 23g**  
23 gauge, curved shaft. Sandblasted tip. Overall length: 22mm.

AXI4809 **Olive Tip Capsule Polisher, 25g**  
25 gauge, curved shaft. Sandblasted tip. Overall length: 28mm.

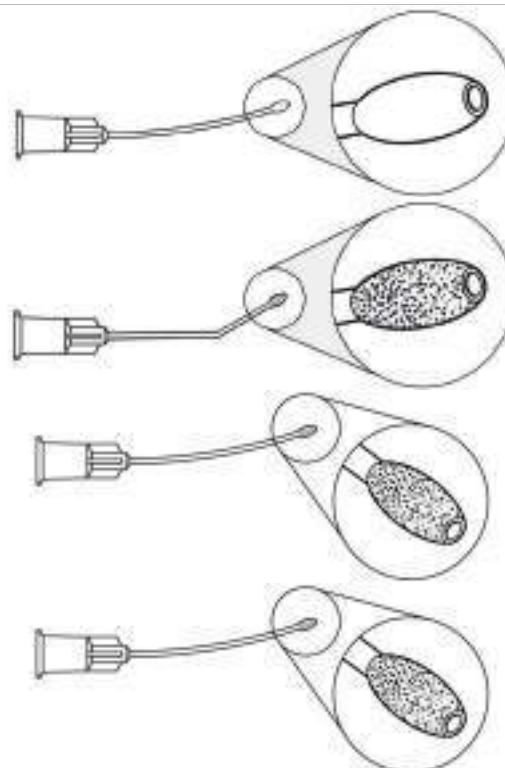

**Chamber Maintainer**

Disposable Chamber Maintainer cannulas range from 20 gauge to 27 gauge in size. Each cannula has a straight shaft with a sharp, closed end tip with a 0.2mm or 0.3mm sideport. Comes with 6" silicone tubing and has an overall length of 22mm. Sold 10 per box.

AXI4820 **Chamber Maintainer, 20g**  
20 gauge, 0.3mm sideport, 6" silicone tubing: ID - 0.75mm (0.030"), OD - 1.65mm (0.065").

AXI4819 **Chamber Maintainer, 23g**  
23 gauge, 0.3mm sideport, 6" silicone tubing: ID - 0.5mm (0.020"), OD - 0.95mm (0.037").

AXI4818 **Chamber Maintainer, 25g**  
25 gauge, 0.2mm sideport, 6" silicone tubing: ID - 0.3mm (0.012"), OD - 0.6mm (0.025").

AXI4817 **Chamber Maintainer, 27g**  
27 gauge, 0.2mm sideport, 6" silicone tubing: ID - 0.3mm (0.012"), OD - 0.6mm (0.025").

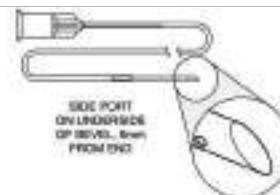

**ACCUSURGICAL SINGLE-USE CANNULAS & CYSTOTOMES**

| Item # | Description | Image |
|--------|-------------|-------|
|--------|-------------|-------|

**Chamber Maintainer with Serrated Tip**

Disposable Chamber Maintainer cannulas range from 23 gauge to 25 gauge in size. Each cannula has a straight shaft with a 4mm serrated, pointed tip with 6" silicone tubing. Overall length: 22mm. Sold 10 per box.

|         |   |
|---------|---|
| AXI4822 | <p><b>Chamber Maintainer, 23g</b></p> <p>23 gauge, 6" silicone tubing: ID - 0.5mm (0.020"), OD - 0.95mm (0.037").</p> |
|---------|---|

|         |  |
|---------|--|
| AXI4821 | <p><b>Chamber Maintainer, 25g</b></p> <p>25 gauge, 6" silicone tubing: ID - 0.3mm (0.012"), OD - 0.6mm (0.025").</p> |
|---------|--|

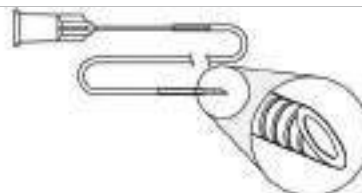

**Infusion Cannula**

Disposable Infusion Cannulas are available in 20 gauge size with straight shafts and 2.5mm to 6mm wide tips. Comes with 6" silicone tubing. Sold 10 per box.

|         |   |
|---------|---|
| AXI4824 | <p><b>Infusion Cannula, 2.5mm</b></p> <p>2.5mm tip, 6" silicone tubing: ID - 0.75mm (0.030"), OD - 1.65 (0.065").</p> |
|---------|---|

|         |   |
|---------|---|
| AXI4825 | <p><b>Infusion Cannula, 4mm</b></p> <p>4mm tip, 6" silicone tubing: ID - 0.75mm (0.030"), OD - 1.65 (0.065").</p> |
|---------|---|

|         |   |
|---------|---|
| AXI4826 | <p><b>Infusion Cannula, 6mm</b></p> <p>6mm tip, 6" silicone tubing: ID - 0.75mm (0.030"), OD - 1.65 (0.065").</p> |
|---------|---|

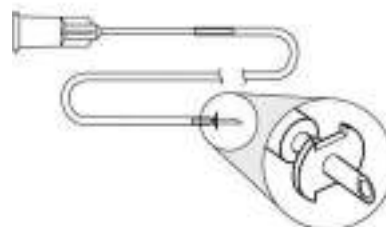

**Membrane Micropick [Eaton]**

20 gauge, straight shaft, tapered to 30 gauge x 5mm distal end, 0.5mm sharp tip, angled 50 degrees toward bevel. Overall length: 25mm. Disposable, sold 10 per box.

|         |                                       |
|---------|---------------------------------------|
| AXI4843 | <p><b>Membrane Micropick, 20g</b></p> |
|---------|---------------------------------------|



**Retinal Backflush Cannula**

Retinal Backflush Cannulas are 23 gauge and have either brush or charles flute tips. Straight shaft. Disposable. Sold 5 per box.

|         |   |
|---------|---|
| AXI5635 | <p><b>Brush Tip Cannula, 23g</b></p> <p>0.9mm silicone brush tip.</p> |
|---------|---|

|         |  |
|---------|--|
| AXI5636 | <p><b>Charles Flute Cannula, 23g</b></p> <p>Blunt tip.</p> |
|---------|--|

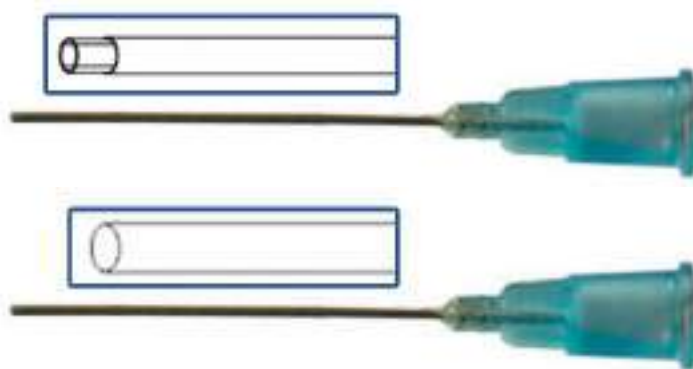

ACCUSURGICAL SINGLE-USE CANNULAS & CYSTOTOMES

| Item #   | Description  | Image |
|--|--|-------|
| <b>Extrusion Cannula</b>   |  |       |
| Disposable Extrusion Cannulas are available in 19 gauge to 23 gauge sizes with a straight shaft. Comes with a tumble polished edge tip and an overall length of 22mm or 25mm. Sold 10 per box. |  |       |
| AXI4835  | <p><b>Extrusion Cannula, 19g</b><br/>                     19 gauge, tapered tip, tapered to 23 gauge, 4mm from end, 1mm distal end, angled 45 degrees. Overall length: 25mm.</p> |       |
| AXI4832  | <p><b>Extrusion Cannula, 19g</b><br/>                     19 gauge, blunt tip. Overall length: 25mm.</p>   |       |
| AXI4833  | <p><b>Extrusion Cannula, 19g</b><br/>                     19 gauge, tapered tip, tapered to 23 gauge, 4mm from end. Overall length: 25mm.</p>                                    |       |
| AXI4827  | <p><b>Extrusion Cannula, 20g</b><br/>                     20 gauge, blunt tip. Overall length: 25mm.</p>   |       |
| AXI4828  | <p><b>Extrusion Cannula, 20g</b><br/>                     20 gauge, tapered tip, tapered to 25 gauge, 4mm from end. Overall length: 25mm.</p>                                    |       |
| AXI4830  | <p><b>Extrusion Cannula, 20g</b><br/>                     20 gauge, tapered tip, tapered to 25 gauge, 4mm from end, 1mm distal end, angled 45 degrees. Overall length: 25mm.</p> |       |
| AXI4837  | <p><b>Extrusion Cannula, 23g</b><br/>                     23 gauge, blunt tip, tumble polished edge. Overall length: 22mm.</p>   |       |

**ACCUSURGICAL SINGLE-USE CANNULAS & CYSTOTOMES**

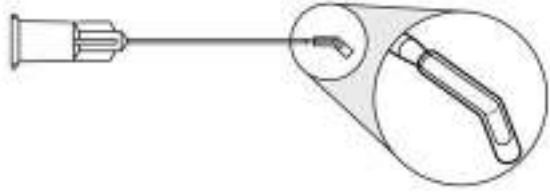
| Item #   | Description  | Image  |
|--|--|--|
| <b>Extrusion Cannula with Silicone Tubing</b>  |  |  |
| Disposable Extrusion Cannulas are available in 19 gauge or 20 gauge sizes with a straight or angled shaft. Has a tapered tip with tubing that bends 4mm from end. Overall length of 25mm. Sold 10 per box. |  |  |
| AXI4834  | <b>Extrusion Cannula, Straight</b><br>19 gauge, tapered to 23 gauge, straight shaft. |  |
| AXI4836  | <b>Extrusion Cannula, Angled</b><br>19 gauge, tapered to 23 gauge, angled shaft.     |  |
| AXI4829  | <b>Extrusion Cannula, Straight</b><br>20 gauge, tapered to 25 gauge, straight shaft. |  |
| AXI4831  | <b>Extrusion Cannula, Angled</b><br>20 gauge, tapered to 25 gauge, angled shaft.     |  |

**High Viscosity Fluid Cannula [Peyman]**

16 gauge, curved shaft, pointed tip. Overall length: 9mm. Disposable, sold 10 per box.

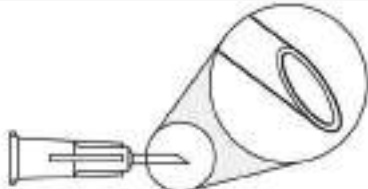
|         |  |   |
|---------|--|---|
| AXI4838 | <b>High Viscosity Fluid Cannula, 16g</b> |  |
|---------|--|---|

**Membrane Dissector [Kingham]**

20 gauge, straight shaft, 0.5mm sharp tip, angled 45 degrees toward bevel. Overall length: 25mm. Disposable, sold 10 per box.

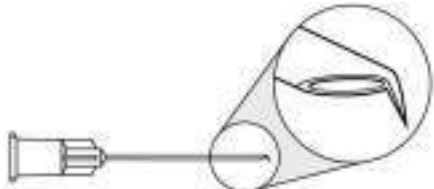
|         |                                |  |
|---------|--------------------------------|--|
| AXI4839 | <b>Membrane Dissector, 20g</b> |  |
|---------|--------------------------------|--|

**Subretinal Injector [Lambert]**

20 gauge, straight shaft, curved, tapered tip, tapered to 33 gauge x 7mm, distal end. Overall length: 25mm. Disposable, sold 10 per box.

|         |                            |  |
|---------|----------------------------|--|
| AXI4840 | <b>Subretinal Injector</b> |  |
|---------|----------------------------|--|

**Subretinal Aspirator [Landers]**

20 gauge, straight shaft, tapered, angled tip, 2.5mm from bend to tip, tapered to 27 gauge x 6mm. Overall length: 25mm. Disposable, sold 10 per box.

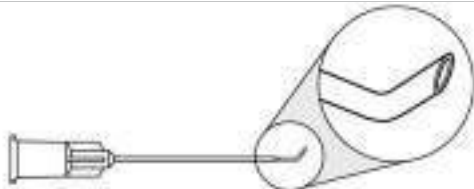
|         |                             |  |
|---------|-----------------------------|--|
| AXI4841 | <b>Subretinal Aspirator</b> |  |
|---------|-----------------------------|--|



**ACCUSURGICAL SINGLE-USE CANNULAS & CYSTOTOMES**

| Item # | Description | Image |
|--------|-------------|-------|
|--------|-------------|-------|

**Vitreoretinal Micropick [Glaser]**

Disposable Glaser Vitreoretinal Micropick cannulas are available in either 20 gauge or 23 gauge with straight tapered shafts. Sharp tips measure 0.5mm in width and are angled 50 degrees toward the bevel. Overall length: 25mm. Sold 10 per box.

|         |  |
|---------|--|
| AXI4844 | <p><b>Vitreoretinal Micropick, 20g</b><br/>20 gauge, tapered to 25 gauge x 3/16" distal end.</p> |
| AXI4845 | <p><b>Vitreoretinal Micropick, 23g</b><br/>23 gauge, tapered to 27 gauge x 3/16" distal end.</p> |

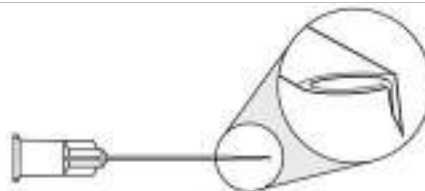

**Vitreoretinal Cannula [Vander]**

Disposable Vitreoretinal Cannulas are 20 gauge in size with straight shafts that are tapered to 30 gauge. Sold 10 per box.

|         |  |
|---------|--|
| AXI4846 | <p><b>Straight Vitreoretinal Cannula</b><br/>Straight tapered tip.</p> |
|---------|--|



|         |  |
|---------|--|
| AXI4847 | <p><b>Angled Vitreoretinal Cannula</b><br/>Angled tapered tip.</p> |
|---------|--|



**Subretinal Injector [Glaser]**

Disposable Glaser Subretinal Injector cannulas come in 20 gauge with a curved or straight shaft. Has a tapered to 33 gauge tip and 3mm distal end. Overall length: 25mm. Sold 10 per box.

|         |  |
|---------|--|
| AXI4848 | <p><b>Curved Subretinal Injector</b><br/>Curved shaft.</p> |
|---------|--|

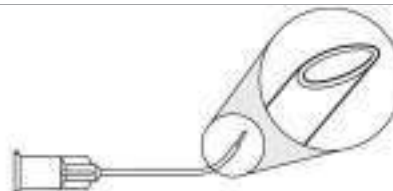

|         |  |
|---------|--|
| AXI4849 | <p><b>Straight Subretinal Injector</b><br/>Straight shaft.</p> |
|---------|--|

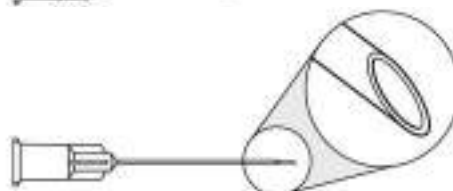

**MVR Cannula [Glaser]**

20 gauge, angled shaft, 1mm from bend to tip, tapered tip 33 gauge x 4mm, distal end. Overall length: 25mm. Disposable, sold 10 per box.

|         |                                |
|---------|--------------------------------|
| AXI4850 | <p><b>MVR Cannula, 20g</b></p> |
|---------|--------------------------------|

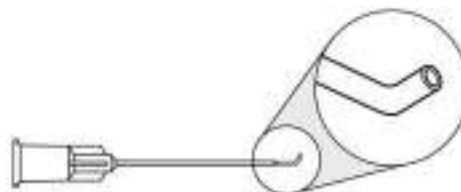



ACCUSURGICAL SINGLE-USE CANNULAS & CYSTOTOMES

| Item # | Description | Image |
|--------|-------------|-------|
|--------|-------------|-------|

**Subretinal Cannula [Lambert]**

20 gauge, straight shaft, curved distal end, tapered to 33 gauge x 7mm. Overall length: 25mm. Disposable, sold 10 per box.

AXI4851      [Subretinal Cannula](#)



**LASIK Cannula [Dishler]**

27 gauge, formed shaft, 9mm from bend to tip, rounded closed tip with 4 sideports. Overall length: 16mm. Disposable, sold 10 per box.

AXI4852      [LASIK Cannula, 27g](#)

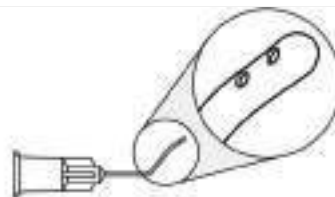

**LASIK Cannula [Slade]**

26 gauge, formed shaft, 9mm from bend to tip, slanted tip. Overall length: 22mm. Disposable, sold 10 per box.

AXI4853      [LASIK Cannula, 26g](#)



**LASIK Cannula [Linn]**

25 gauge, angled shafts, 9mm from bend to tip, flat bend, 2 ports, open end. Disposable, sold 10 per box.

AXI4855      [LASIK Cannula, 25g](#)

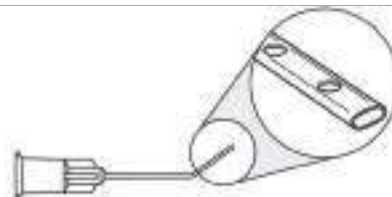

**Refractive Cannula**

25 gauge, angled shaft, dual shafts, 8 ports, closed tip. Disposable, sold 10 per box.

AX205256      [Refractive Cannula, 25g](#)



ACCUSURGICAL SINGLE-USE CANNULAS & CYSTOTOMES

| Item # | Description | Image |
|--------|-------------|-------|
|--------|-------------|-------|

**Femtosecond Cannula [Solomon]**

30 gauge hydrodissector, angled shaft, 7mm from bend to tip, sandblasted, oval-shaped tip. Disposable, sold 10 per box.

AXI5227 **Femtosecond Cannula**



**Brody Femtosecond Dissecting Cannula**

The Brody Femtosecond Dissecting Cannula for laser-assisted cataract surgery is a disposable 25 gauge stainless steel cannula that both easily opens laser incisions and allows for fast, efficient injection of intraocular lidocaine and/or viscoelastic. This elegant device is placed either on a TB syringe filled with lidocaine or directly on the viscoelastic syringe (for those not using intraocular anesthetic). The shovel-like tip allows for easy and safe opening of both the sideport and the main incision. Single-use design removes the need for sterilization. Combination of spatula and cannula reduces the number of instrument hand-offs between scrub tech and surgeon, saving time and improving efficiency. Unique tip design with 25 gauge width reduces wound stretching when compared to other laser incision instrumentation.

AX20001 **Femtosecond Dissecting Cannula**

Sold 10 per box.

AX20001-BULK **Femtosecond Dissecting Cannula**

Sold 100 per bag.



**AccuDrop Cannula**

AccuDrop is Accutome's dropleless therapy cannula. It was designed by Accutome for administration of dropleless cataract drug formulation. The AccuDrop Cannula is a blunt tip cannula that is designed to reduce zonular trauma. Sideport opening allows for gentle drug dispersion. Angled 90 degree shaft facilitates easier insertion into the anterior chamber to make a targeted drug delivery. Disposable, sold 10 per box.

AXI5581 **AccuDrop Cannula, 25g**

25 gauge.

AXI5630 **AccuDrop Cannula, 27g**

27 gauge.



REUSABLE CANNULAS & CYSTOTOMES







| Item #  | Description  | Image |
|---|--|-------|
| <b>Atkinson Retrobulbar Needle</b>  |  |       |
| Reusable Atkinson Retrobulbar Needles are available from 19 gauge to 27 gauge in size with straight shafts and sharp, beveled tips. Overall length: 35mm. |  |       |
| AC0190 19   | <b>Atkinson Retrobulbar Needle, 19g</b><br>19 gauge. |       |
| AC0190 20   | <b>Atkinson Retrobulbar Needle, 20g</b><br>20 gauge. |       |
| AC0190 23   | <b>Atkinson Retrobulbar Needle, 23g</b><br>23 gauge. |       |
| AC0190 25   | <b>Atkinson Retrobulbar Needle, 25g</b><br>25 gauge. |       |
| AC0190 27   | <b>Atkinson Retrobulbar Needle, 27g</b><br>27 gauge. |       |

**Air Injection Cannula**

Reusable Air Injection Cannulas are available from 23 gauge to 30 gauge in size and have either an angled or straight shaft. Various tip types are available. Overall length: 19mm.

|        |  |  |
|--------|--|--|
| AC0125 | <b>Air Injection Cannula, 23g</b><br>23 gauge, angled shaft, 45-degree angle, 7mm from bend to tip, blunt tip. |  |
| AC0145 | <b>Air Injection Cannula, 25g</b><br>25 gauge, angled shaft, 45-degree angle, 5mm from bend to tip, blunt tip. |  |
| AC0110 | <b>Air Injection Cannula, 27g</b><br>27 gauge, angled shaft, 45-degree angle, 5mm bend to tip.                 |  |
| AC0122 | <b>Air Injection Cannula, 27g</b><br>27 gauge, straight shaft.   |  |
| AC0105 | <b>Air Injection Cannula, 27g</b><br>27 gauge, angled shaft, 45-degree angle, 5mm from bend to tip, oval tip.  |  |

REUSABLE CANNULAS & CYSTOTOMES







| Item # | Description   | Image  |
|--------|---|--|
| AC0120 | <b>Air Injection Cannula, 27g</b><br>27 gauge, angled shaft, 45-degree angle, 7mm bend to tip, blunt tip. |    |
| AC0121 | <b>Air Injection Cannula, 27g</b><br>27 gauge, angled shaft, 8mm bend to tip.                             |    |
| AC0130 | <b>Air Injection Cannula, 30g</b><br>30 gauge, angled shaft, 45-degree angle, 5mm bend to tip, blunt tip. |    |
| AC0131 | <b>Air Injection Cannula, 30g</b><br>30 gauge, straight shaft, blunt tip.                                 |   |
| AC0140 | <b>Air Injection Cannula, 30g</b><br>30 gauge, angled shaft, 45-degree angle, 7mm bend to tip, blunt tip. |  |
| AC0141 | <b>Air Injection Cannula, 30g</b><br>30 gauge, angled shaft, 45-degree angle, 8mm bend to tip, blunt tip. |  |

Gills-Welsh Aspirating Cannula

Reusable 25 gauge Gills-Welsh Aspirating Cannulas have 45-degree angled shafts with blunt, open tips. Various overall lengths and bend size.

|           |  |  |
|-----------|--|--|
| AC0320 5  | <b>Aspirating Cannula, 5mm Bend</b><br>5mm from bend to tip. Overall length: 18mm.   |  |
| AC0320 7  | <b>Aspirating Cannula, 7mm Bend</b><br>7mm from bend to tip. Overall length: 21mm.   |  |
| AC0320 8  | <b>Aspirating Cannula, 8mm Bend</b><br>8mm from bend to tip. Overall length: 21mm.   |  |
| AC0320 10 | <b>Aspirating Cannula, 10mm Bend</b><br>10mm from bend to tip. Overall length: 21mm. |  |

REUSABLE CANNULAS & CYSTOTOMES

| Item #   | Description  | Image  |
|--|--|--|
| <b>McIntyre Anterior Chamber Cannula</b>   |  |  |
| Reusable McIntyre Anterior Chamber Cannulas range from 23 gauge to 30 gauge and come in both angled and straight shaft patterns with blunt, open tips. Overall length: 18mm. |  |  |
| AC0620   | <p data-bbox="261 449 464 470"><b>McIntyre Cannula, 23g</b></p> <p data-bbox="261 485 769 533">23 gauge, angled shaft, 45-degree angle, 12mm from bend to tip.</p>     |    |
| AC0760   | <p data-bbox="261 638 464 659"><b>McIntyre Cannula, 23g</b></p> <p data-bbox="261 674 477 701">23 gauge, straight shaft.</p>   |    |
| AC0630   | <p data-bbox="261 827 464 848"><b>McIntyre Cannula, 26g</b></p> <p data-bbox="261 863 769 911">26 gauge, angled shaft, 45-degree angle, 12mm from bend to tip.</p>     |    |
| AC0740   | <p data-bbox="261 1016 464 1037"><b>McIntyre Cannula, 26g</b></p> <p data-bbox="261 1052 477 1079">26 gauge, straight shaft.</p>                                       |  |
| AC0640   | <p data-bbox="261 1205 464 1226"><b>McIntyre Cannula, 30g</b></p> <p data-bbox="261 1241 769 1289">30 gauge, angled shaft, 45-degree angle, 12mm from bend to tip.</p> |  |
| AC0750   | <p data-bbox="261 1394 464 1415"><b>McIntyre Cannula, 30g</b></p> <p data-bbox="261 1430 477 1457">30 gauge, straight shaft.</p>                                       |  |

REUSABLE CANNULAS & CYSTOTOMES

| Item # | Description | Image |
|--------|-------------|-------|
|--------|-------------|-------|

**McIntyre-Binkhorst Irrigating Cannula**

Reusable 26 gauge McIntyre-Binkhorst Irrigating Cannulas with angled or straight shafts. Tip is a 2.6mm wide J-shaped tip with a blunt front opening. Overall length: 18mm.

AC0800 **McIntyre-Binkhorst Irrigating Cannula, Right**  
26 gauge, angled right shaft, 13mm from bend to tip.

AC0810 **McIntyre-Binkhorst Irrigating Cannula, Straight**  
26 gauge, straight shaft.

AC0820 **McIntyre-Binkhorst Irrigating Cannula, Left**  
26 gauge, angled left shaft, 13mm from bend to tip.



**Bishop-Harmon Irrigating Cannula**

Reusable Bishop-Harmon Irrigating Cannulas are available from 18 gauge to 27 gauge in size and have angled or straight shafts. Tips are flattened and blunt. Overall length: 24mm.

AC0230 18 **Bishop-Harmon Irrigating Cannula, 18g**  
18 gauge, angled shaft, 35-degree angle, 7mm from bend to tip.

AC0230 19 **Bishop-Harmon Irrigating Cannula, 19g**  
19 gauge, angled shaft, 35-degree angle, 7mm from bend to tip.



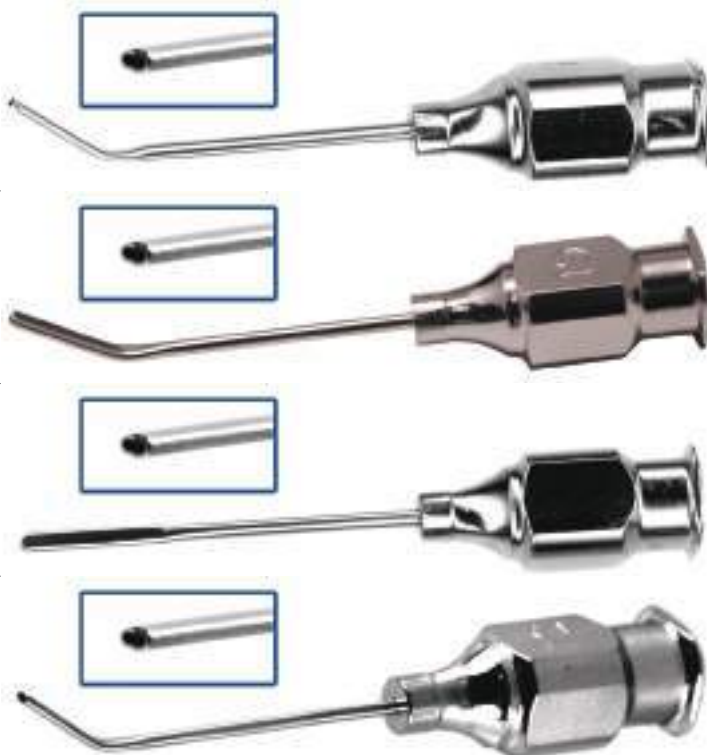

AC0231 19 **Bishop-Harmon Irrigating Cannula, 19g**  
19 gauge, straight shaft.

AC0230 21 **Bishop-Harmon Irrigating Cannula, 21g**  
21 gauge, angled shaft, 35-degree angle, 7mm from bend to tip.



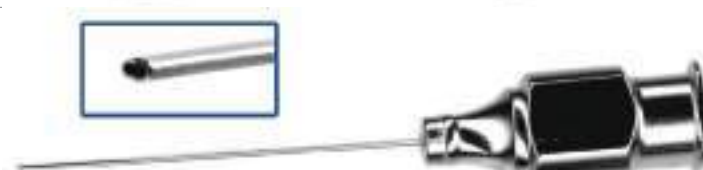

REUSABLE CANNULAS & CYSTOTOMES

| Item #    | Description  | Image  |
|-----------|--|--|
| AC0230 23 | <b>Bishop-Harmon Irrigating Cannula, 23g</b><br>23 gauge, angled shaft, 35-degree angle, 7mm from bend to tip. |    |
| AC0230 25 | <b>Bishop-Harmon Irrigating Cannula, 25g</b><br>25 gauge, angled shaft, 35-degree angle, 7mm from bend to tip. |    |
| AC0230 26 | <b>Bishop-Harmon Irrigating Cannula, 26g</b><br>26 gauge, angled shaft, 35-degree angle, 7mm from bend to tip. |    |
| AC0230 27 | <b>Bishop-Harmon Irrigating Cannula, 27g</b><br>27 gauge, angled shaft, 35-degree angle, 7mm from bend to tip. |   |
| AC0231 27 | <b>Bishop-Harmon Irrigating Cannula, 27g</b><br>27 gauge, straight shaft.                                      |  |

**Bishop-Harmon Irrigating Cannula Bulb**

Bishop-Harmon Irrigating Cannula Bulb measures 25mm in diameter, translucent silicone. Overall length: 63mm.

AC0220 **Bishop-Harmon Irrigating Cannula Bulb**



**Adapter for Irrigators**

Bishop-Harmon Adapter. Adapts to cannula hubs. Plastic, blue material. Overall length: 22mm.

AC0230 A **Bishop-Harmon Adapter**



REUSABLE CANNULAS & CYSTOTOMES

| Item # | Description | Image |
|--------|-------------|-------|
|--------|-------------|-------|

**Bishop-Harmon Irrigating Cannula Set**

Reusable Bishop-Harmon Irrigating Cannula Sets are available from 19 gauge to 25 gauge in size and have angled shafts. Each set includes 1 cannula, 1 adapter for irrigators (AC0230A), and 1 silicone bulb (AC0220).

AC0230 19 CS **Bishop-Harmon Cannula Set, 19g**

19 gauge.

AC0230 23 CS **Bishop-Harmon Cannula Set, 23g**

23 gauge.

AC0230 25 CS **Bishop-Harmon Cannula Set, 25g**

25 gauge.



**Cystotome Cannula**

Reusable Cystotome Cannulas range from 25 gauge to 27 gauge with angled shafts that are 12mm from bend to tip. Cannulas have small cystotome sharp cutting edge tips and are irrigating. Overall length: 15mm.

AC4175 **Cystotome Cannula, 25g**

25 gauge.

AC4174 **Cystotome Cannula, 27g**

27 gauge.



**Lewicky Cystotome**

Angled shaft, 10mm from bend to tip, equilateral triangular tip, blunt base. Round handle. Overall length: 114mm.

AH0305 **Lewicky Cystotome**



**Hydrodissection Cannula**

Hydrodissection cannulas ranging in gauge size from 23 gauge to 30 gauge with straight or angled shafts.

AC0460 23 **Hydrodissection Cannula, 23g**

23 gauge, angled shaft, 35 degree angle 8mm from bend to tip, flattened horizontal tip. Overall length: 22mm.

AC0460 **Hydrodissection Cannula, 25g**

25 gauge, angled shaft, 35 degree angle 8mm from bend to tip, flattened horizontal tip. Overall length: 22mm.

AC0465 **Hydrodissection Cannula, 25g**

25 gauge, straight shaft, 2.5mm J-shaped tip with 0.3mm flattened tip. Overall length: 18mm.







REUSABLE CANNULAS & CYSTOTOMES

| Item # | Description   | Image |
|--------|---|-------|
| AC0485 | <p><b>Hydrodissection Cannula, 25g</b><br/>                     25 gauge, straight shaft, 3mm wide U-shaped tip. Overall length: 25mm.</p>  |       |
| AC0459 | <p><b>Hydrodissection Cannula, 25g</b><br/>                     25 gauge, angled shaft, 11mm from bend to tip, flattened tip. Overall length: 22mm.</p>                           |       |
| AC0462 | <p><b>Hydrodissection Cannula, 25g</b><br/>                     25 gauge, angled left shaft, 10mm from bend to tip, 3mm wide U-shaped tip. Overall length: 25mm.</p>              |       |
| AC0463 | <p><b>Hydrodissection Cannula, 25g</b><br/>                     25 gauge, angled right shaft, 10mm from bend to tip, 3mm wide U-shaped tip. Overall length: 25mm.</p>             |       |
| AC0457 | <p><b>Hydrodissection Cannula, 27g</b><br/>                     27 gauge, angled shaft, 11mm from bend to tip, flattened tip. Overall length: 22mm.</p>                           |       |
| AC0467 | <p><b>Hydrodissection Cannula, 27g</b><br/>                     27 gauge, straight shaft, J-shaped tip. Overall length: 25mm.</p>   |       |
| AC0469 | <p><b>Hydrodissection Cannula, 27g</b><br/>                     27 gauge, angled left shaft, 10mm from bend to tip, 3mm wide U-shaped tip. Overall length: 25mm.</p>              |       |
| AC0461 | <p><b>Hydrodissection Cannula, 27g</b><br/>                     27 gauge, angled shaft, 35-degree angle 8mm from bend to tip, flattened horizontal tip. Overall length: 22mm.</p> |       |

REUSABLE CANNULAS & CYSTOTOMES

| Item # | Description  | Image  |
|--------|--|--|
| AC0473 | <b>Hydrodissection Cannula, 27g</b><br>27 gauge, angled right shaft, 10mm from bend to tip, 3mm wide U-shaped tip. Overall length: 25mm. |  |
| AC0458 | <b>Hydrodissection Cannula, 30g</b><br>30 gauge, angled shaft, 11mm from bend to tip, flattened tip. Overall length: 22mm.               |  |
| AC0466 | <b>Hydrodissection Cannula, 30g</b><br>30 gauge, straight shaft, J-shaped tip. Overall length: 25mm.                                     |  |

**Akahoshi II Hydrodissection Cannula**

27 gauge, curved shaft, 1mm bend to tip, beveled tip. Overall length: 19mm.

|        |  |  |
|--------|--|--|
| AC0478 | <b>Akahoshi II Hydrodissection Cannula</b> |  |
|--------|--|--|

**Chang Nucleus Hydrodissection Cannula**

Reusable Chang Nucleus Hydrodissection Cannulas come in 27 gauge with 90-degree angled shafts and flat tips with beveled openings. Overall length: 16mm.

|        |  |  |
|--------|--|--|
| AC0475 | <b>1.5mm Chang Hydrodissection Cannula</b><br>1.5mm flat standard tip. |  |
| AC0476 | <b>3mm Chang Hydrodissection Cannula</b><br>3.0mm flat long tip.       |  |

REUSABLE CANNULAS & CYSTOTOMES

| Item # | Description | Image |
|--------|-------------|-------|
|--------|-------------|-------|

**Simcoe Cortex Extractor Cannula**

Reusable 23 and 25 gauge Simcoe Cortex Extractor Cannulas with 13mm and 21mm curved shafts. Cannulas have closed rounded tips with a 0.3mm aspiration port that faces into the shaft. Overall length: 21mm.

|           |  |
|-----------|--|
| ACI030 21 | <b>Simcoe Cannula, 23g</b><br>23 gauge, 21mm curved shaft. |
| ACI030 13 | <b>Simcoe Cannula, 23g</b><br>23 gauge, 13mm curved shaft. |
| ACI030 25 | <b>Simcoe Cannula, 25g</b><br>25 gauge, 21mm curved shaft. |



**Infusion Cannula**

Infusion cannulas ranging from 20 gauge to 23 gauge, come with tubing and luer-adapter.

|        |   |
|--------|---|
| AC0665 | <b>Infusion Cannula, 20g</b><br>20 gauge, 6mm beveled tip luer-adapter, comes with 26cm tubing.   |
| AC0666 | <b>Infusion Cannula, 20g</b><br>20 gauge, 4mm beveled tip luer-adapter, comes with 26cm tubing.   |
| AC0675 | <b>Infusion Cannula, 22g</b><br>22 gauge, angled luer-adapter, 7mm from bend to tip, self-retaining beveled tip, comes with silicone tubing and luer-adapter. |
| AC2262 | <b>Infusion Cannula, 23g</b><br>23 gauge, 5mm beveled tip luer-adapter, comes with 26cm tubing.   |
| AC2263 | <b>Infusion Cannula, 23g</b><br>23 gauge, 6mm beveled tip luer-adapter, comes with 26cm tubing.   |



**Anis Cortex Aspirating Cannula**

23 gauge, angled shaft, 35-degree angle, thin wall, 1.5mm from bend to tip, 0.4mm sideport opening, sandblasted tip. Reusable. Overall length: 26mm.

|        |                                       |
|--------|---------------------------------------|
| AC0160 | <b>Anis Cortex Aspirating Cannula</b> |
|--------|---------------------------------------|



**Graether Collar Button Cannula**

23 gauge Graether Collar Button Cannulas with straight or curved shafts. Collar button tip with roughened posterior surface.

|        |   |
|--------|---|
| AC0390 | <b>Collar Button Cannula, Straight</b><br>Straight shaft. Overall length: 25mm. |
|--------|---|



REUSABLE CANNULAS & CYSTOTOMES

| Item # | Description  | Image  |
|--------|--|--|
| AC0400 | <p><b>Collar Button Cannula, Angled</b></p> <p>Angled shaft, 45-degree angle, 10mm from bend to tip.<br/>Overall length: 22mm.</p> |  |

**Infusion Handle**

Reusable Infusion Handles that are made from stainless steel. Available with various connectors and overall lengths.

|        |   |  |
|--------|---|--|
| AC1300 | <p><b>Male Infusion Handle</b></p> <p>Male to male connector. Overall length: 10cm.</p> |  |
|--------|---|--|

|        |   |  |
|--------|---|--|
| AC1305 | <p><b>Female Infusion Handle</b></p> <p>Male to female luer lock connector. Overall length: 10cm.</p> |  |
|--------|---|--|

|        |  |  |
|--------|--|--|
| AC6540 | <p><b>Tubing Infusion Handle</b></p> <p>Male to tubing connector. Overall length: 7.5cm.</p> |  |
|--------|--|--|

|        |   |  |
|--------|---|--|
| AC1301 | <p><b>Tubing Infusion Handle</b></p> <p>Male to tubing connector. Overall length: 11.5cm.</p> |  |
|--------|---|--|

**Henderson MICS Capsule Polisher Cannula**

23 gauge, curved shaft, 0.3mm port facing down, lightly sandblasted 1.25mm saucer-shaped tip. Overall length: 21mm.

|        |   |  |
|--------|---|--|
| AC2155 | <p><b>Henderson MICS Capsule Polisher Cannula</b></p> |  |
|--------|---|--|

REUSABLE CANNULAS & CYSTOTOMES

| Item # | Description | Image |
|--------|-------------|-------|
|--------|-------------|-------|

**Jensen Capsule Polisher**

Reusable Jensen Capsule Polishers are available in 23 gauge and 25 gauge with curved shafts. Whole capsule and posterior capsule polishers are available with carbide impregnated sandblasted tips. Overall length: 28mm.

|        |   |  |
|--------|---|--|
| AC2140 | <b>Posterior Capsule Polisher, 23g</b><br>Posterior capsule polisher, 23 gauge. |  |
| AC2130 | <b>Posterior Capsule Polisher, 25g</b><br>Posterior capsule polisher, 25 gauge. |  |
| AC2110 | <b>Capsule Polisher, 23g</b><br>Whole capsule polisher, 23 gauge.               |  |
| AC2120 | <b>Capsule Polisher, 25g</b><br>Whole capsule polisher, 25 gauge.               |  |

**Gills-Welsh Olive Tip Cannula**

25 gauge, angled shaft, 45-degree angle, 10mm from bend to tip, 1mm stainless steel ball tip. Overall length: 26mm.

|        |                                      |  |
|--------|--------------------------------------|--|
| AC0350 | <b>Gills-Welsh Olive Tip Cannula</b> |  |
|--------|--------------------------------------|--|

**Lacrimal Cannula**

Lacrimal cannulas ranging from 20 gauge to 27 gauge with various shafts and tips.

|        |   |  |
|--------|---|--|
| AC0584 | <b>Lacrimal Cannula, 20g</b><br>20 gauge, straight shaft, blunt closed tip with sideport opening. Overall length: 28mm.     |  |
| AC0590 | <b>Lacrimal Cannula, 22g</b><br>22 gauge, malleable straight shaft, blunt flared probe tip. Overall length: 19mm.           |  |
| AC0560 | <b>Lacrimal Cannula, 23g</b><br>23 gauge, curved 19 gauge reinforced shaft, 10mm tip, open blunt tip. Overall length: 31mm. |  |
| AC0570 | <b>Lacrimal Cannula, 23g</b><br>23 gauge, straight 19 gauge reinforced shaft, 12mm blunt open tip. Overall length: 32mm.    |  |

REUSABLE CANNULAS & CYSTOTOMES

| Item #    | Description   | Image |
|-----------|---|-------|
| AC0580    | <b>Lacrimal Cannula, 23g</b><br>23 gauge, straight shaft, blunt open tip. Overall length: 25mm.                               |       |
| AC0583    | <b>Lacrimal Cannula, 25g</b><br>25 gauge, straight shaft, blunt open tip. Overall length: 25mm.                               |       |
| AC0560 27 | <b>Lacrimal Cannula, 27g</b><br>27 gauge, curved 19 gauge reinforced shaft, 10mm tip, open blunt tip. Overall length: 32mm.   |       |
| AC0561    | <b>Lacrimal Cannula, 27g</b><br>27 gauge, straight 19 gauge reinforced shaft, 12mm tip, open blunt tip. Overall length: 32mm. |       |
| AC0582    | <b>Lacrimal Cannula, 27g</b><br>27 gauge, straight shaft, blunt open tip. Overall length: 25mm.                               |       |

**Bailey Lacrimal Cannula**

Reusable reinforced Bailey Lacrimal Cannulas are available in 23 gauge or 27 gauge with straight, 19 gauge reinforced shafts. Tips are 6mm in size and have a blunt, open end. Overall length: 14mm.



|        |  |  |
|--------|--|--|
| AC0200 | <b>Bailey Lacrimal Cannula, 23g</b><br>23 gauge. |  |
| AC0201 | <b>Bailey Lacrimal Cannula, 27g</b><br>27 gauge. |  |

**Fasanella Lacrimal Cannula**

Reusable Fasanella Lacrimal Cannulas ranging from 23 gauge to 27 gauge with gently curved reinforced shafts and 22mm open, blunt tips. Overall length: 42mm.

|        |  |  |
|--------|--|--|
| AC0565 | <b>Lacrimal Cannula, 23g</b><br>23 gauge, 19 gauge reinforced shaft. |  |
| AC0566 | <b>Lacrimal Cannula, 25g</b><br>25 gauge, 20 gauge reinforced shaft. |  |
| AC0567 | <b>Lacrimal Cannula, 27g</b><br>27 gauge, 21 gauge reinforced shaft. |  |

## REUSABLE CANNULAS &amp; CYSTOTOMES





| Item #   | Description                        | Image   |
|--|------------------------------------|---|
| <b>Simcoe I/A Cannula</b>  |                                    |   |
| 23 gauge, curved thin wall shaft, 0.3mm aspiration through top port, irrigation through side opening, comes with 10-inch tubing and luer-lock adapter. Overall length: 15mm. |                                    |   |
| AC1040   | <a href="#">Simcoe I/A Cannula</a> |  <p>The image shows a Simcoe I/A Cannula, which consists of a thin, curved metal shaft with a black luer-lock adapter at one end. A clear plastic tube is attached to the other end. An inset image provides a magnified view of the tip of the cannula, showing the aspiration and irrigation ports.</p> |
| <b>Slade LASIK Cannula</b>   |                                    |   |
| 26 gauge, angled shaft, 9mm from bend to tip, flattened spatulated tip with front port opening. Overall length: 16mm.  |                                    |   |
| AC5400   | <a href="#">Slade Cannula, 26g</a> |  <p>The image shows a Slade LASIK Cannula, which is a stainless steel instrument with a long, thin, angled shaft. The shaft ends in a flattened, spatulated tip with a small front port opening. The handle is a cylindrical metal piece with a luer-lock adapter.</p>                                    |





# Capsule Polishers



## NON-IRRIGATING CAPSULE POLISHERS

| Item #   | Description                                   | Image  |
|--|---|--|
| <b>Accutome Capsule Polishing Sweeper and Curette</b>  |   |  |
| Double-ended, one angled shaft with sweeper tip, 10mm from bend to tip, rounded, teardrop shaped, flat tip, 0.8mm wide. One straight shaft with ring curette, 90 degree angled ring tip, 1.8mm in diameter. Round handle. Overall length: 147mm. |   |  |
| AH0228   | <a href="#">Accutome Capsule Polisher</a>     |    |
| <b>Gills-Welsh Capsule Polishing Curette</b>   |   |  |
| Angled shaft, 8mm from bend to tip, 2mm diameter cup tip. Flat handle. Overall length: 121mm.  |   |  |
| AH0130   | <a href="#">Gills-Welsh Capsule Curette</a>   |    |
| <b>Holladay Posterior Capsule Polisher and Curette</b>   |   |  |
| Straight shaft, 0.5mm diameter tip, sandblasted side on reverse of curette. Round handle. Overall length: 127mm.   |   |  |
| AH0240   | <a href="#">Holladay Posterior Capsule</a>    |  |
| <b>Nightingale Posterior Capsule Polishing Curette</b>   |   |  |
| Angled shaft, open ring tip, 1.75 diameter, semi-sharp edge. Round handle. Overall length: 124mm.  |   |  |
| AH0220   | <a href="#">Nightingale Polishing Curette</a> |  |
| <b>Shepherd Capsule Polishing Curette</b>  |   |  |
| Angled shaft, 10mm from bend to tip, 1.75mm diameter ring tip, semi-sharp top and bottom edges. Flat handle. Overall length: 121mm.  |   |  |
| AH0225   | <a href="#">Shepherd Capsule Polisher</a>     |  |



## NON-IRRIGATING CAPSULE POLISHERS

| Item #  | Description                                 | Image  |
|---|---|--|
| <b>Singer Sweep Polisher</b>  |   |  |
| Double-ended, angled shafts, angled left and right, 10mm from bend to tip, rounded paddle tips, 0.75mm wide tips. Round handle. Overall length: 148mm.  |   |  |
| AH7210  | <a href="#">Singer Sweep Polisher</a>       |  <p>The image shows a Singer Sweep Polisher, a double-ended dental instrument with two angled shafts. Two inset boxes provide close-up views of the rounded paddle tips. The main image shows the full instrument with its round handle.</p>                                   |
| <b>Whitman Sheperd Capsule Polisher</b>   |   |  |
| Double-ended, angled shafts, angled left and right, 10mm from bend to tip, low profile ring tips, 1.75mm diameter rings, semi-sharp top and bottom edges of rings. Round handle. Overall length: 145mm. |   |  |
| AH0226  | <a href="#">Whitman Sheperd Polisher</a>    |  <p>The image shows a Whitman Sheperd Capsule Polisher, a double-ended dental instrument with two angled shafts. The main image shows the full instrument with its round handle.</p>   |
| <b>Accutome 360-Degree Capsule Polishing Curette</b>  |   |  |
| Angled shaft, 13mm from bend to tip, unique multi-bend tip, 1.60mm diameter ring tip with semi-sharp top and bottom edges. Round handle. Overall length: 121mm.   |   |  |
| AH0222  | <a href="#">360-Degree Capsule Polisher</a> |  <p>The image shows an Accutome 360-Degree Capsule Polishing Curette, a dental instrument with a single angled shaft and a unique multi-bend tip. An inset box provides a close-up view of the ring tip. The main image shows the full instrument with its round handle.</p> |



# Chalazion Instruments

CURETTES

| Item #  | Description  | Image  |
|---|--|--|
| <b>Heath Chalazion Ring Curette</b>                                     |  |  |
| Straight shaft, ring height 1.5mm. Round handle. Overall length: 131mm. |  |  |
| AH0140  | <b>Heath Chalazion Curette, No. 1</b><br>1mm diameter ring.                  |  |
| AH0150  | <b>Heath Chalazion Curette, No. 2</b><br>2mm diameter ring.                  |  |
| AH0160  | <b>Heath Chalazion Curette, No. 3</b><br>3mm diameter ring.                  |  |
| <b>Meyerhoeffer Chalazion Curette</b>                                   |  |  |
| Straight 31mm shaft and various cup sizes. Flat handle.                 |  |  |
| AH0170  | <b>Chalazion Curette, Number 0 Cup</b><br>1.5mm cup. Overall length: 125mm.  |  |
| AH0180  | <b>Chalazion Curette, Number 1 Cup</b><br>1.75mm cup. Overall length: 125mm. |  |
| AH0190  | <b>Chalazion Curette, Number 2 Cup</b><br>2.0mm cup. Overall length: 124mm.  |  |
| AH0200  | <b>Chalazion Curette, Number 3 Cup</b><br>2.5mm cup. Overall length: 124mm.  |  |
| AH0210  | <b>Chalazion Curette, Number 4 Cup</b><br>3.5mm cup. Overall length: 125mm.  |  |

# Lens Manipulators & Choppers

LENS MANIPULATORS

| Item # | Description | Image |
|--------|-------------|-------|
|--------|-------------|-------|

**Anis Ball Tip Nucleus Manipulator**

Angled shaft, 10mm from bend to tip, ball tip, 0.5mm diameter tip. Round handle. Overall length: 115mm.

|        |   |  |
|--------|---|--|
| AH4450 | <a href="#">Anis Ball Tip Nucleus Manipulator</a> |  |
|--------|---|--|



**Barrett Duo Nucleus Rotator/Manipulator/Splitter**

Titanium, double-ended, angled shafts, 14mm from bend to tip, straight sharp inner/outer sides of splitter tip, cutting edge 90 degrees to axis, 10mm from bend to tip, 0.65mm mushroom tip manipulator. Round handle. Overall length: 121mm.

|        |  |  |
|--------|--|--|
| AH4282 | <a href="#">Round Handle Nucleus Rotator</a> |  |
|--------|--|--|



**Bechert Lens Pusher**

Angled shaft, 7mm from bend to tip, Y-shaped tip, vertical rotator tip. Round handle. Overall length: 124mm.

|        |                                     |  |
|--------|-------------------------------------|--|
| AH1580 | <a href="#">Bechert Lens Pusher</a> |  |
|--------|-------------------------------------|--|

**Bechert Nucleus Rotator**

Angled shaft, 7mm from bend to tip, Y-shaped tip. Round handle. Overall length: 120mm.

|        |   |  |
|--------|---|--|
| AH4100 | <a href="#">Stainless Steel Rotator</a> |  |
|        | Stainless steel handle.                 |  |

|         |                                  |  |
|---------|----------------------------------|--|
| AH4100T | <a href="#">Titanium Rotator</a> |  |
|         | Titanium handle.                 |  |





**Clayman Nucleus Rotator**

Angled shaft, 10mm from bend to tip, V-notched tip, 0.5mm wide flat spatula. Flat handle. Overall length: 121mm.

|        |   |  |
|--------|---|--|
| AH4110 | <a href="#">Clayman Nucleus Rotator</a> |  |
|--------|---|--|



LENS MANIPULATORS

| Item #   | Description  | Image  |
|--|--|--|
| <b>Drysdale Nucleus Manipulator</b>  |  |  |
| Angled shaft, 10mm from bend to tip, flattened paddle tip. Round handle.   |  |  |
| AH4120   | <b>Drysdale Nucleus Manipulator</b><br>Overall length: 110mm   |    |
| AH4125   | <b>Drysdale Manipulator Anterior</b><br>Anterior capsule polisher. Overall length: 112mm.                  |  |
| <b>Fenzel Lens Manipulating Hook</b>   |  |  |
| Angled and straight shaft, 0.15mm diameter tip. Round handle.  |  |  |
| AH0560   | <b>Fenzl Lens Manipulating Hook, Angled</b><br>Angled shaft, 10mm from bend to tip. Overall length: 115mm. |   |
| AH0550   | <b>Fenzl Lens Manipulating Hook, Straight</b><br>Straight shaft, T-shaped tip. Overall length: 121mm.      |  |
| <b>Grayson Nucleus Manipulator</b>   |  |  |
| Angled shaft, 10mm from bend to tip, 0.8mm flat, olive-shaped tip, flattened with smooth, defined internal edge. Round handle. Overall length: 115mm.                  |  |  |
| AH4121   | <b>Grayson Nucleus Manipulator</b>   |  |
| <b>Grayson/Kuglen Double-Ended Manipulator</b>   |  |  |
| Double-ended, angled shafts, 10mm from bend to tip, 0.8mm flat olive shaped tip, 9mm from bend to tip, push/pull model, H-shaped. Round handle. Overall length: 140mm. |  |  |
| AH4122   | <b>Grayson-Kuglen Double-Ended Manipulator</b>   |  |



**LENS MANIPULATORS**

| Item # | Description | Image |
|--------|-------------|-------|
|--------|-------------|-------|

**Hunkeler IOL Manipulator**

Angled shaft, 10mm from bend to tip, slightly curved, 0.3mm diameter hemi-ball tip. Round handle. Overall length: 115mm.

|        |  |   |
|--------|--|---|
| AH1510 | <a href="#">Hunkeler IOL Manipulator</a> |  |
|--------|--|---|



**Jaffe-Bechert Nucleus Rotator**

Angled shaft, 9mm from bend to tip, Y-shaped tip. Round handle. Overall length: 120mm.

|        |  |   |
|--------|--|---|
| AH4140 | <a href="#">Stainless Steel Rotator</a><br>Stainless steel handle. |  |
|--------|--|---|

|          |  |   |
|----------|--|---|
| AH4140TI | <a href="#">Titanium Rotator</a><br>Titanium handle. |  |
|----------|--|---|



**Koch Phacoemulsification Manipulator**

Curved shaft, 0.8mm wide, duckbill shaped tip. Round handle. Overall length: 115mm.

|        |  |   |
|--------|--|---|
| AH5380 | <a href="#">Koch Phaco Manipulator</a> |  |
|--------|--|---|



**Koch Stop and Chop Manipulator**

Angled shaft, 10mm from bend to tip, 1.5mm long tip. Round handle. Overall length: 118mm.

|        |  |   |
|--------|--|---|
| AH5385 | <a href="#">Koch Stop and Chop Manipulator</a> |  |
|--------|--|---|











**Lester IOL Manipulator**

Hourglass/teardrop-shaped tip, 0.25mm tip. Round handle. Overall length: 115mm.

|        |  |   |
|--------|--|---|
| AH1520 | <a href="#">Vaulted IOL Manipulator</a><br>Vaulted shaft, 10mm from bend to tip. |  |
|--------|--|---|



LENS MANIPULATORS

| Item #  | Description   | Image   |
|---------|---|---|
| AHI530  | <b>Angled IOL Manipulator</b><br>Angled shaft, 10mm from bend to tip.           | <br>   |
| AHI530T | <b>Angled IOL Manipulator</b><br>Titanium, angled shaft, 10mm from bend to tip. | <br>   |
| AHI540  | <b>Straight IOL Manipulator</b><br>Straight shaft.                              | <br>   |
| AHI540T | <b>Straight IOL Manipulator</b><br>Titanium, straight shaft.                    | <br> |



**Lewicky Lens Manipulator Hook**

Angled shaft, 9mm from bend to tip, slightly curved, 0.15mm tip. Flat handle. Overall length: 115mm.

|        |                                      |  |
|--------|--------------------------------------|--|
| AHI140 | <b>Lewicky Lens Manipulator Hook</b> |  |
|--------|--------------------------------------|--|

**Lieberman Microfinger Nucleus Manipulator**

Angled shaft, 10mm from bend to tip, unique C-shaped microfinger tip. Round handle. Overall length: 115mm.

|          |   |   |
|----------|---|---|
| AH0860   | <b>Right Microfinger Nucleus Manipulator</b><br>Right-hand use. |  |
| AH0870 C | <b>Left Microfinger Nucleus Manipulator</b><br>Left-hand use.   |   |
|          |   |   |

LENS MANIPULATORS

| Item # | Description | Image |
|--------|-------------|-------|
|--------|-------------|-------|

**Lindstrom STAR Manipulator**

Titanium, angled shaft, 12mm from bend to tip, multi-directional cross action star tip. Round handle. Overall length: 117mm.

AH0695T [Lindstrom STAR Manipulator](#)



**Mackool Double-Ended Chopper and Spatula**

Double-ended, angled shafts, 10mm from bend to tip. Micro 0.38mm ball-shaped blunt tip. Interior cutting edge, 11mm from bend to tip, cylindrical spatula, 0.4mm blade. Round handle. Overall length: 138mm.

AH7125 [Mackool Double-Ended Chopper and Spatula](#)



**Maloney No Hole IOL Manipulator**

Straight shaft, vaulted 7mm from tip, 0.25mm diameter teardrop shaped tip. Round handle. Overall length: 118mm.

AH1550 [Maloney No Hole IOL Manipulator](#)



**Maloney Nucleus Rotator**

Double-ended, angled shafts, 12mm from bend to tips, 0.5mm spatula tip, 0.6mm forked tip. Round handle. Overall length: 134mm.

AH4135 [Maloney Nucleus Rotator](#)











**Maltsman-Fenzel Lens Manipulating Hook**

Straight and angled shafts, V-shaped tip, 0.15mm tip. Round handle. Overall length: 118mm.





AH0680 [Maltzman-Fenzl Lens Hook, Straight](#)  
Straight shaft.









## LENS MANIPULATORS

| Item #  | Description   | Image   |
|---|---|---|
| AH0690  | <b>Maltzman-Fenzl Lens Hook, Angled</b><br>Angled shaft, 10mm from bend to tip. | <br>     |
| <b>Hunkeler IOL Manipulator</b>   |   |   |
| Angled shaft, hemi-ball tip, 0.3mm diameter tip. Round handle. Overall length: 105mm.   |   |   |
| AH1560  | <b>Hunkeler IOL Manipulator</b>   |   |
| <b>Masket Phaco Spatula</b>   |   |   |
| Double-ended, angled shafts, 9mm from bend to tip, phaco splitter. 60-degree interior cutting edge, blunt tip, 12mm from bend to tip, cylindrical spatula, flat disc shaped tip. Round handle. Overall length: 136mm. |   |   |
| AH4300  | <b>Masket Phaco Spatula</b>   |    |
| <b>Nordan Capsule Elevator</b>  |   |   |
| Angled shaft, used for placing IOL in the bag. Round handle.  |   |   |
| AH1570  | <b>Nordan Capsule Elevator</b>  | <br> |
| <b>O'Gawa Lens Dialer</b>   |   |   |
| Angled shaft, 10mm from bend to tip, collar button style tip. Round handle. Overall length: 118mm.  |   |   |
| AH4220  | <b>O'Gawa Lens Dialer</b>   | <br> |







## LENS MANIPULATORS

| Item #   | Description   | Image  |
|--|---|--|
| <b>Osher "Y" IOL Hook</b>  |   |  |
| Straight shaft, Y-shaped tip. Round handle. Overall length: 124mm.   |   |  |
| AH0710   | <a href="#">Osher "Y" IOL Hook</a>  |    |
| <b>Osher Iris Retractor</b>  |   |  |
| Straight shaft, oval button tip. Round handle. Overall length: 121mm.                                      |   |  |
| AH2135   | <a href="#">Osher Iris Retractor</a>                                      |    |
| <b>Osher Nucleus Manipulator</b>   |   |  |
| Straight shaft, blunt finger-like tip, 0.5mm two-prong, K-shaped tip. Round handle. Overall length: 114mm. |   |  |
| AH0730   | <a href="#">Osher Nucleus Manipulator</a>                                 |  |
| <b>Pisacano Nucleus Rotator</b>  |   |  |
| Angled shaft, 10.5mm from bend to tip, 1mm disc shaped tip. Round handle. Overall length: 115mm.           |   |  |
| AH4160   | <a href="#">Horizontal Nucleus Rotator</a><br>Horizontal disc-shaped tip. |  |
| AH4161   | <a href="#">Vertical Nucleus Rotator</a><br>Vertical disc-shaped tip.     |  |

LENS MANIPULATORS

| Item #  | Description  | Image  |
|---|--|--|
| <b>Rentsch Boat Hook Lens Manipulator</b>   |  |  |
| Straight shaft, split hook tip. Round handle. Overall length: 115mm.  |  |  |
| AH0740  | <a href="#">Rentsch Boat Hook Lens Manipulator</a>   |    |
| <b>Siepsner Endocapsular Controller</b>   |  |  |
| Angled shaft, 12mm from bend to tip, 0.7mm trumpet-shaped tip. Round handle. Overall length: 118mm.                     |  |  |
| AH4190  | <a href="#">Siepsner Endocapsular Controller</a>   |    |
| <b>Sinskey C-Hook, Modified</b>   |  |  |
| Curved shaft, 10mm from tip to first bend, offset shaft, 0.2mm diameter tip, blunt. Flat handle. Overall length: 120mm. |  |  |
| AH1150  | <a href="#">Sinskey C-Hook, Modified</a>   |  |
| <b>Sinskey Lens Manipulating Hook</b>   |  |  |
| Straight and angled shafts with 0.2mm or 0.25mm diameter blunt tip.   |  |  |
| AH1155  | <a href="#">Sinskey Hook, Angled</a><br>Angled shaft, 12mm from bend to tip, 0.2mm diameter blunt tip reversed. Round handle. Overall length: 115mm. |  |
| AH1160  | <a href="#">Sinskey Hook, Angled</a><br>Angled shaft, 10mm from bend to tip, 0.2mm diameter blunt tip. Round handle. Overall Length: 111mm.          |  |
| AH1165  | <a href="#">Sinskey Hook, Straight</a><br>Straight shaft, 0.2mm diameter blunt tip. Round handle. Overall length: 115mm.                             |  |

LENS MANIPULATORS

| Item #   | Description  | Image  |
|----------|--|--|
| AH1170   | <b>Sinskey Hook, Angled</b><br>Angled shaft, 10mm from bend to tip, 0.2mm diameter blunt tip. Flat handle. Overall length: 115mm.            |    |
| AH1175   | <b>Sinskey Hook, Straight</b><br>Straight shaft, 0.2mm diameter blunt tip. Flat handle. Overall length: 120mm.                               |    |
| AH1210   | <b>Sinskey Hook, Angled</b><br>Titanium. Angled shaft, 10mm from bend to tip, 0.2mm diameter blunt tip. Round handle. Overall length: 115mm. |    |
| AH1110   | <b>Sinskey Hook, Angled</b><br>Angled shaft, 10mm from bend to tip, 0.25mm diameter blunt tip. Flat handle. Overall length: 115mm.           |   |
| AH1200   | <b>Sinskey Hook, Angled</b><br>Angled shaft, 10mm from bend to tip, 0.25mm diameter blunt tip. Round handle. Overall length: 115mm.          |  |
| AH1190   | <b>Sinskey Hook, Straight</b><br>Straight shaft, 0.25mm diameter blunt tip. Round handle. Overall length: 120mm.                             |  |
| AH1190TI | <b>Sinskey Hook, Straight</b><br>Titanium, straight shaft, 0.25mm diameter blunt tip. Round handle. Overall length: 120mm.                   |  |

**Tennant Nucleus Manipulator**

Angled shaft, 10mm from bend to tip, 0.37mm ball shaped tip. Round handle. Overall length: 118mm.

|        |                                    |  |
|--------|------------------------------------|--|
| AH4200 | <b>Tennant Nucleus Manipulator</b> |  |
|--------|------------------------------------|--|







CHOPPERS

| Item # | Description | Image |
|--------|-------------|-------|
|--------|-------------|-------|

**Accutome Wand**

The Accutome Wands are made from titanium and stainless steel. They are available with straight and angled shafts and curved and angled tips with a 0.5mm diameter ball. Round handle. Overall length: 115mm.

|         |  |  |
|---------|--|--|
| AH7100T | <p><b>Straight Wand</b><br/>Titanium, straight shaft, curved tip.</p>                              |    |
| AH7101  | <p><b>Curved Wand</b><br/>Stainless steel, curved shaft, curved tip.</p>                           |    |
| AH7105T | <p><b>Angled Wand</b><br/>Titanium, angled shaft, 10.0mm from bend to tip.</p>                     |   |
| AH7106T | <p><b>Angled Wand</b><br/>Titanium, angled shaft, 10mm from bend to tip, 90-degree angled tip.</p> |  |
| AH7107T | <p><b>Straight Wand</b><br/>Titanium, straight shaft, 90-degree angled tip.</p>                    |  |

**Akahoshi Nucleus Sustainer**

Angled shaft, 10mm from bend to tip, paddle-shaped blade, right side dished out. Round handle. Overall length: 115mm.

|        |  |  |
|--------|--|--|
| AH7110 | <p><b>Akahoshi Nucleus Sustainer</b></p> |  |
|--------|--|--|

CHOPPERS

| Item # | Description | Image |
|--------|-------------|-------|
|--------|-------------|-------|

**Ambidextrous Seibel Nucleus Chopper**

Angled shaft, 15mm from bend to tip, curved interior cutting edge, 0.5mm olive-shaped tip. Ambidextrous, round handle. Overall length: 117mm.

|        |   |   |
|--------|---|---|
| AH4173 | <a href="#">Ambidextrous Seibel Nucleus Chopper</a> |  |
|--------|---|---|



**Castroviejo Dissector**

Angled shaft, 5mm from bend to tip, 1.5mm wide x 5mm flat angled blade. Flat handle. Overall length: 119mm.

|        |                                       |  |
|--------|---------------------------------------|--|
| AH6545 | <a href="#">Castroviejo Dissector</a> |  |
|--------|---------------------------------------|--|



**Chang Microfinger Phaco Chopper and Quick Chopper**

Double-ended, angled shafts, 10mm from bend to tip, C-shaped blunt chopper tip, 1.0mm pointed sharp quick chop tip. Round handle. Overall length: 137mm.

|        |  |  |
|--------|--|--|
| AH4290 | <a href="#">Left Chopper</a><br>Left-hand use. |  |
|--------|--|--|

|        |  |   |
|--------|--|---|
| AH4295 | <a href="#">Right Chopper</a><br>Right-hand use. |  |
|--------|--|---|

|         |  |  |
|---------|--|--|
| AH4290T | <a href="#">Left Chopper</a><br>Titanium, left-hand use. |  |
|---------|--|--|



**Chang-Seibel Microfinger Chopper and Vertical Safety Chopper**

Double-ended, angled shafts, 10mm from bend to tips, unique C-shaped microfinger chopper with blunt tip, 0.5mm olive-shaped blade with 1.0mm bend. Round handle. Overall length: 138mm.

|        |  |  |
|--------|--|--|
| AH4289 | <a href="#">Right Chopper</a><br>Right-hand use. |  |
|--------|--|--|

|        |  |   |
|--------|--|---|
| AH4288 | <a href="#">Left Chopper</a><br>Left-hand use. |  |
|--------|--|---|



**Davidoff Ambidextrous Nucleus Chopper**

Angled shaft, 10mm from bend to tip, blunt tip, triangle-shaped cutting edge. Ambidextrous use, round handle. Overall length: 115mm.

|        |  |  |
|--------|--|--|
| AH4205 | <a href="#">Stainless Steel Davidoff Nucleus Chopper</a><br>Stainless steel. |  |
|--------|--|--|

|         |  |  |
|---------|--|--|
| AH4205T | <a href="#">Titanium Davidoff Nucleus Chopper</a><br>Titanium. |  |
|---------|--|--|



CHOPPERS

| Item # | Description | Image |
|--------|-------------|-------|
|--------|-------------|-------|

**Dodick-Kammann Nucleus Chopper**

Angled shaft, 12mm from bend to tip, 2mm long interior cutting edge, blunt tip. Round handle. Overall length: 112mm.

AH4236 [Dodick-Kammann Nucleus Chopper](#)



**Escaf Nucleus Sustainer**

Angled shaft, 10mm from bend to tip, smooth ball tip. Round handle. Overall length: 115mm.

AH7130 [Escaf Nucleus Sustainer](#)



**Fukasaku Snapper Chopper**

Angled shaft, 10mm from bend to tip, blunt tip, wedge shaped interior cutting edge. Round handle. Overall length: 118mm.

AH4210 [Fukasaku Nucleus Chopper](#)



**Goldberg Sideport Splitter**

Angled shaft, 10mm from bend to tip, 0.8mm flat teardrop shaped tip, blunt. Round handle. Overall length: 113mm.

AH4115 [Goldberg Sideport Splitter](#)



**Haefliger Phaco Cleaver**

Angled shaft, 10mm from bend to tip, dull, curved cleaver tip. Round handle. Overall length: 115mm.

AH4216 [Haefliger Phaco Cleaver, Right](#)  
Right-hand use.

AH4215 [Haefliger Phaco Cleaver, Left](#)  
Left-hand use.



CHOPPERS

| Item # | Description | Image |
|--------|-------------|-------|
|--------|-------------|-------|

**He Hook Chopper**

Titanium, angled shaft, 10.5mm from bend to tip, interior cutting edge, hook shaped tip, blunt tip. Round handle. Overall length: 113mm.

|        |  |
|--------|--|
| AH4380 | <b>Right Hook Chopper</b><br>Right-hand use. |
|--------|--|

|        |  |
|--------|--|
| AH4381 | <b>Left Hook Chopper</b><br>Left-hand use. |
|--------|--|



**Keener Lens/Nucleus Divider**

One preformed snare wire loop. Round handle. Comes with three additional loops.

|        |                        |
|--------|------------------------|
| AH3215 | <b>Nucleus Divider</b> |
|--------|------------------------|



**Koch Spatula and Nagahara Chopper**

Double-ended, curved shaft, 0.8mm wide spatula duckbill-shaped tip, angled shaft, 10mm from bend to tip. 1.5mm, 60-degree chopper cutting edge. Round handle. Overall length: 126mm.

|        |  |
|--------|--|
| AH4195 | <b>Koch Spatula and Nagahara Chopper</b> |
|--------|--|



**Lieberman Microfinger and Spatula**

Double-ended, angled shafts, 10mm from bend to tip. C-shaped chopper, blunt tip, 0.5mm wide flat spatula. Round handle. Overall length: 142mm.

|        |   |
|--------|---|
| AH0880 | <b>Right Microfinger/Spatula</b><br>Right-hand use. |
|--------|---|

|        |   |
|--------|---|
| AH0890 | <b>Left Microfinger/Spatula</b><br>Left-hand use. |
|--------|---|



**Mackool Phaco Chopper**

Angled shaft, 10mm from bend to tip, micro ball shaped tip, blunt, interior cutting edge. Round handle. Overall length: 114mm.

|        |  |
|--------|--|
| AH4145 | <b>Stainless Steel Chopper</b><br>Stainless steel. |
|--------|--|









|        |                                      |
|--------|--------------------------------------|
| AH7115 | <b>Titanium Chopper</b><br>Titanium. |
|--------|--------------------------------------|



CHOPPERS

| Item #   | Description  | Image |
|--|--|-------|
| <b>Mackool Phaco Chopper and Nucleus Chopper</b>   |  |       |
| Double-ended. Round handle.  |  |       |
| AH4375   | <b>Mackool Double-Ended Chopper, Right</b><br>Right-hand use.      |       |
| AH4376   | <b>Mackool Double-Ended Chopper, Left</b><br>Left-hand use.        |       |
| <b>Maloney Quick-Chop</b>  |  |       |
| Titanium. Double-ended, angled shafts, 9mm from bend to tip, quick-chop tip, 10mm from bend to tip, micro sharp pick tip. Round handle. Overall length: 133mm. |  |       |
| AH4385T  | <b>Maloney Quick-Chop</b>  |       |
| <b>Nagahara Fine Chopper and Nichamin Quick Chopper</b>  |  |       |
| Double-ended, 10mm from bend to tips, wedge-shaped cutting edge, fine interior cutting edge, blunt tip. Left-hand use, round handle. Overall length: 140mm.    |  |       |
| AH4182   | <b>Nagahara Fine Chopper-Nichamin</b>                              |       |
| <b>Nagahara Phaco Chopper</b>  |  |       |
| Angled shaft, 45 degrees, 10mm from bend to tip, 1.5mm tip, flat interior cutting edge, 60 degrees. Round handle. Overall length: 114mm.                       |  |       |
| AH4240   | <b>Stainless Steel Chopper</b><br>Stainless steel, ambidextrous.   |       |
| AH4240TI   | <b>Titanium Chopper</b><br>Titanium, ambidextrous.                 |       |
| AH4242   | <b>Stainless Steel Chopper</b><br>Stainless steel, right-hand use. |       |
| AH4242T  | <b>Titanium Chopper</b><br>Titanium, right-hand use.               |       |
| AH4243   | <b>Stainless Steel Chopper</b><br>Stainless steel, left-hand use.  |       |

CHOPPERS

| Item #  | Description  | Image   |
|---|--|---|
| <b>Nichamin Double-Ended Nucleus Chopper and Spatula</b>  |  |   |
| Double-ended, wedge-shaped chopper, 0.5mm spatula, blunt tip. Round handle. Overall length: 140mm.  |  |   |
| AH4400  | <a href="#">Nichamin Double-Ended Nucleus Chopper and Spatula</a>                  |   |
| <b>Nichamin Quick Chopper</b>   |  |   |
| Titanium, angled shaft, 10mm from bend to tip, wedge-shaped cutting edge. Round handle. Overall length: 115mm.  |  |   |
| AH4184T1  | <a href="#">Nichamin Quick Chopper, Left</a><br>Left-hand use.                     |    |
| AH4185T   | <a href="#">Nichamin Quick Chopper, Right</a><br>Right-hand use.                   |   |
| <b>Nichamin Quick Chopper II</b>  |  |   |
| Vaulted shaft, 10mm from bend to tip, eye-shaped wedged cutting edge, slightly angled tip. Right-hand use, round handle. Overall length: 114mm.   |  |   |
| AH4184  | <a href="#">Nichamin II Quick Chopper, Right</a>                                   | <br> |
| <b>Nichamin Triple Chopper</b>  |  |   |
| Angled shaft, 10mm from bend to tip, unique multi-directional cutting edge. Round handle. Overall length: 114mm.  |  |   |
| AH4265  | <a href="#">Nichamin Triple Chopper</a>  |   |
| <b>Nucleus Chopper and Safety Quick Chopper</b>   |  |   |
| Double-ended, angled shafts. One end is angled 15mm from bend to tip with curved interior cutting edge and 0.5mm olive-shaped tip. One end is angled 10mm from bend to tip with 0.5mm olive-shaped blade and 1.0mm bend. Round handle. Overall length: 138mm. |  |   |
| AH4171T   | <a href="#">Titanium Chopper, Right</a><br>Titanium, right-hand use.               |   |
| AH4345  | <a href="#">Stainless Steel Chopper, Right</a><br>Stainless steel, right-hand use. |    |
| AH4172T   | <a href="#">Titanium Chopper, Left</a><br>Titanium, left-hand use.                 |   |
| AH4346  | <a href="#">Stainless Steel Chopper, Left</a><br>Stainless steel, left-hand use.   |   |

CHOPPERS

| Item # | Description | Image |
|--------|-------------|-------|
|--------|-------------|-------|

**Rosen Chopper**

Angled shaft, 9.0mm from bend to tip, blunt tip, interior cutting edge, wedge-shaped. Round handle. Overall length: 114mm.

|          |   |  |
|----------|---|--|
| AH4170   | <b>Stainless Steel Chopper</b><br>Stainless steel, 45-degree interior cutting edge. |  |
| AH4170TI | <b>Titanium Chopper</b><br>Titanium, 45-degree interior cutting edge.               |  |
| AH4180   | <b>Stainless Steel Chopper</b><br>Stainless steel, 60-degree interior cutting edge. |  |
| AH4180T  | <b>Titanium Chopper</b><br>Titanium, 60-degree interior cutting edge.               |  |

**Seibel Nucleus Chopper**

Angled shaft, 15mm from bend to tip, curved interior cutting edge, 0.5mm olive-shaped tip. Round handle. Overall length: 117mm.

|        |   |  |
|--------|---|--|
| AH4175 | <b>Seibel Nucleus Chopper, Right</b><br>Right-hand use. |  |
| AH4176 | <b>Seibel Nucleus Chopper, Left</b><br>Left-hand use.   |  |

**Seibel Nucleus Chopper and Safety Quick Chopper**

Double-ended, angled shafts, 10mm from bend to tips, 0.5mm olive-shaped tips, one quick-chop tip, one curved interior cutting edge tip. Round handle. Overall length: 140mm.

|        |   |  |
|--------|---|--|
| AH4177 | <b>Double-Ended Chopper, Right</b><br>Right-hand use. |  |
| AH4178 | <b>Double-Ended Chopper, Left</b><br>Left-hand use.   |  |

**Seibel Safety Quick Chopper**

Angled shaft, 10mm from bend to tip, 0.5mm olive shaped tip, 1.0mm bend at tip. Left-hand use, round handle. Overall length: 115mm.

|        |  |  |
|--------|--|--|
| AH4179 | <b>Seibel Safety Quick Chopper, Left</b> |  |
|--------|--|--|



CHOPPERS

| Item # | Description | Image |
|--------|-------------|-------|
|--------|-------------|-------|

**Steinert II Nucleus Claw Chopper**

Vaulted shaft, 10mm from bend to tip, J-shaped chopper, cutting edge. Ambidextrous, round handle. Overall length: 118mm.

|        |  |
|--------|--|
| AH4218 | <a href="#">Steinert II Nucleus Claw Chopper</a> |
|--------|--|



**Sweeney Manipulator Cracker**

Angled shaft, 10mm from bend to tip, flat paddle-shaped tip that is spooned out on left side. Round handle. Overall length: 113mm.

|        |   |
|--------|---|
| AH4126 | <a href="#">Stainless Steel Manipulator Cracker</a><br>Stainless steel. |
|--------|---|

|         |   |
|---------|---|
| AH4126T | <a href="#">Titanium Manipulator Cracker</a><br>Titanium. |
|---------|---|



**Verges Phaco Chopper**





Angled shaft, 12mm from bend to tip, semi-curved centered interior cutting edge, 0.4mm olive-shaped tip. Ambidextrous, round handle. Overall length: 112mm.

|        |                                      |
|--------|--------------------------------------|
| AH4275 | <a href="#">Verges Phaco Chopper</a> |
|--------|--------------------------------------|







# Hooks & Retractors

## HOOKS





| Item #   | Description  | Image  |
|--|--|--|
| <b>Bonn Iris Hook</b>  |  |  |
| Straight shaft, curved 0.3mm hooked tip. Flat handle. Overall length: 123mm.   |  |  |
| AH2100   | <a href="#">Bonn Iris Hook</a>                       |    |
| <b>Clayman Micro Iris Hook</b>   |  |  |
| Angled shaft, 45-degree, 9mm shaft, 0.3mm hook. Flat handle. Overall length: 105mm.  |  |  |
| AH2110   | <a href="#">Clayman Iris Hook</a>                    |    |
| <b>Clayman-Jaffe Lens Manipulating Hook</b>  |  |  |
| Angled shaft, 10mm from bend to tip, 0.15mm diameter blunt tip. Flat handle. Overall length: 115mm.  |  |  |
| AH1100   | <a href="#">Clayman-Jaffe Lens Manipulating Hook</a> |  |
| <b>Crawford Retrieving Hook</b>  |  |  |
| Straight shaft, hooked tip. Round handle. Overall length: 143mm.   |  |  |
| AH0905   | <a href="#">Crawford Retrieving Hook</a>             |  |
| <b>Crawford/Benger Probe Retrieving Hook</b>   |  |  |
| Angled shaft, 10mm from bend to tip, 65mm shaft, used for retrieving the Crawford/Benger intubation probes, flattened J-shaped tip. Round handle. Overall length: 130mm. |  |  |
| AH7120   | <a href="#">Crawford Hook</a>                        |  |

## HOOKS







| Item #   | Description  | Image  |
|--|--|--|
| <b>Culler Rectus Muscle Hook</b>   |  |  |
| Straight shaft, flattened hook tip, 7mm hook. Flat handle. Overall length: 125mm.  |  |  |
| AH0605   | <a href="#">Culler Rectus Muscle Hook</a>  |    |
| <b>Double Fixation Hook</b>  |  |  |
| Straight shaft, double prong hooked tip, sharp tips. Flat handle. Overall length: 128mm.   |  |  |
| AH0530   | <a href="#">1.5mm Fixation Hook</a><br>1.5mm spread between curved tips.               |    |
| AH0540   | <a href="#">2mm Fixation Hook</a><br>2mm spread between curved tips.                   |  |
| <b>Fukasaku Snapper Hook</b>   |  |  |
| Angled shaft, 10mm from bend to tip, wedge-shaped flat interior cutting edge, blunt tip, front notch for engaging iris. Round handle. Overall length: 114mm. |  |  |
| AH1600   | <a href="#">Fukasaku Snapper Hook</a>  |  |
| <b>Gass Retinal Detachment Hook</b>  |  |  |
| Straight shaft, Graefe hook tip, 13mm hook, 1.5mm oval hole. Flat handle. Overall length: 143mm.   |  |  |
| AH0580   | <a href="#">Gass Retinal Detachment Hook</a>   |  |
| <b>Graether Collar Button-Handle</b>   |  |  |
| Straight and angled shafts. Iris retractor and capsule polisher with roughened posterior surface. Round handle. Overall length: 116mm.                       |  |  |
| AH2120   | <a href="#">Graether Collar Button, Angled</a><br>Angled shaft, 10mm from bend to tip. |  |











## HOOKS

| Item #  | Description  | Image  |
|---|--|--|
| AH2130  | <b>Graether Collar Button, Straight</b><br>Straight shaft. |   |
| <b>Hirschman Iris Hook</b>  |  |  |
| Angled shaft, 45 degree, 9mm from bend to tip, H-shaped 0.75mm hook tip. Round handle. Overall length: 122mm. |  |  |
| AH2140  | <b>Hirschman Iris Hook</b>                                 |    |
| <b>Iris Hook</b>  |  |  |
| Straight shaft, blunt curved hook. Flat handle. Overall length: 125mm.  |  |  |
| AH2150  | <b>Iris Hook</b>   |  |
| <b>Jaffe Iris Hook</b>  |  |  |
| Straight shaft, 1.2mm hooked tip, blunt. Flat handle. Overall length: 127mm.                                  |  |  |
| AH2160  | <b>Jaffe Iris Hook</b>                                     |  |
| <b>Jaffe Lens Manipulating Hook</b>   |  |  |
| Straight shaft, blunt tip, 0.15mm diameter tip. Flat handle. Overall length: 121mm.                           |  |  |
| AH1130  | <b>Jaffe Lens Manipulating Hook</b>                        |  |

HOOKS

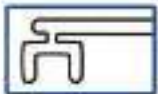
| Item #  | Description   | Image   |
|---|---|---|
| <b>Jaffe-Maltzman Lens Manipulating Hook</b>  |   |   |
| Angled shaft, 10mm from bend to tip, 0.15mm V-shaped tip. Flat handle. Overall length: 118mm.   |   |   |
| AH0600  | <a href="#">Jaffe-Maltzman Lens Hook</a>  |  <p>The image shows a Jaffe-Maltzman Lens Manipulating Hook, which is a long, thin, angled instrument with a flat handle and a V-shaped tip. A small inset icon in the top right corner shows a stylized 'J' shape.</p> |
| <b>Kirby Expressor Double-Ended Hook and Loop</b>   |   |   |
| Double-ended, straight shafts, curved 5mm x 10mm loop, smooth loop, 10mm wide muscle/expressor hook. Round handle. Overall length: 155mm. |   |   |
| AH3160  | <a href="#">Kirby Expressor Double-Ended Hook and Loop</a>  |  <p>The image shows a Kirby Expressor Double-Ended Hook and Loop, which is a long, thin instrument with a round handle and two curved loops at the ends.</p>  |
| <b>Kuglen Iris Hook Lens Manipulator</b>  |   |   |
| Straight and angled shafts with either K-hook or push-pull type tips. Round or flat handle options. Overall length: 115mm.                |   |   |
| AH0630  | <a href="#">Iris Hook and Lens Manipulator, Angled</a><br>Angled shaft, push-pull tip, 10mm from bend to tip. Flat handle.            |  <p>The image shows an Iris Hook and Lens Manipulator, Angled, with a flat handle and a push-pull tip. A small inset icon in the top right corner shows a stylized 'K' shape.</p>                                     |
| AH0630TI  | <a href="#">Iris Hook and Lens Manipulator, Angled</a><br>Titanium, angled shaft, 10mm from bend to tip, push-pull tip. Round handle. |  <p>The image shows an Iris Hook and Lens Manipulator, Angled, with a round handle and a push-pull tip. A small inset icon in the top right corner shows a stylized 'K' shape.</p>                                    |
| AH0630T   | <a href="#">Iris Hook and Lens Manipulator, Angled</a><br>Titanium, angled shaft, 10mm from bend to tip, push-pull tip. Flat handle.  |  <p>The image shows an Iris Hook and Lens Manipulator, Angled, with a flat handle and a push-pull tip. A small inset icon in the top right corner shows a stylized 'K' shape.</p>                                     |
| AH0640  | <a href="#">Iris Hook and Lens Manipulator, Straight</a><br>Straight shaft, push-pull tip. Flat handle.                               |  <p>The image shows an Iris Hook and Lens Manipulator, Straight, with a flat handle and a push-pull tip. A small inset icon in the top right corner shows a stylized 'K' shape.</p>                                   |

HOOKS

| Item #  | Description  | Image  |
|---------|--|--|
| AH0650  | <b>Iris Hook and Lens Manipulator, Straight</b><br>Straight shaft, push-pull tip. Round handle.                              | <br>  |
| AH0660  | <b>Iris Hook and Lens Manipulator, Angled</b><br>Angled shaft, 10mm from bend to tip, push-pull tip. Round handle.           | <br>  |
| AH0670  | <b>Iris Hook and Lens Manipulator, Straight</b><br>Straight shaft, 0.5mm K-hook. Flat handle.                                | <br>  |
| AH0675T | <b>Iris Hook and Lens Manipulator, Angled</b><br>Titanium, angled shaft, 10mm from bend to tip, push-pull tip. Round handle. | <br> |

**Maumenee Iris Hook**

Straight shaft, curved hook tip. 1mm blunt tip. Flat handle. Overall length: 121mm.

|        |                           |  |
|--------|---------------------------|--|
| AH2190 | <b>Maumenee Iris Hook</b> |  |
|--------|---------------------------|--|



**Shepard Iris Hook**

Straight shaft, 1mm hooked tip, 1 blunt prong, small. Flat handle. Overall length: 127mm.





|        |                          |  |
|--------|--------------------------|--|
| AH2230 | <b>Shepard Iris Hook</b> |  |
|--------|--------------------------|--|

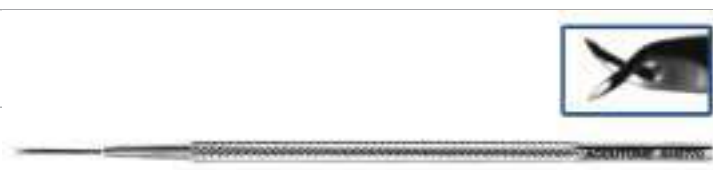



## HOOKS

| Item #  | Description  | Image   |
|---|--|---|
| <b>Sinskey Iris and IOL Hook</b>  |  |   |
| Straight shaft, 0.2mm hooked tip. Flat serrated handle. Overall length: 118mm.  |  |   |
| AH1180  | <a href="#">Sinskey Iris and IOL Hook</a>  |  A long, thin surgical hook with a flat serrated handle and a 0.2mm hooked tip. An inset image shows a close-up of the tip. |
| <b>Smith Expressor Hook</b>   |  |   |
| Straight shaft, curved 11.5mm hooked tip. Flat handle. Overall length: 150mm.   |  |   |
| AH6950  | <a href="#">Smith Expressor Hook</a>   |  A long, thin surgical hook with a flat handle and a curved 11.5mm hooked tip.  |
| <b>Stevens Tenotomy Hook</b>  |  |   |
| Straight shaft, 6mm hook shaped tip, blunt. Flat handle. Overall length: 120mm. |  |   |
| AH0750  | <a href="#">Stevens Tenotomy Hook</a>  |  A long, thin surgical hook with a flat handle and a 6mm hook shaped tip.   |
| <b>Twist Fixation Hook</b>  |  |   |
| Straight shaft, clockwise and counter-clockwise twist hooks. Round handle.      |  |   |
| AH0760  | <a href="#">Twist Fixation Hook, 0.3mm</a><br>Small, 0.3mm, left, counter-clockwise twist hook. Overall length: 110mm. |  A long, thin surgical hook with a round handle and a twist fixation tip. An inset image shows a close-up of the tip.     |
| AH0770  | <a href="#">Twist Fixation Hook, 0.3mm</a><br>Small, 0.3mm, right, clockwise twist hook. Overall length: 110mm.        |   |
| AH0780  | <a href="#">Twist Fixation Hook, 0.5mm</a><br>Large, 0.5mm, left, counter-clockwise twist hook. Overall length: 127mm. |   |
| AH0790  | <a href="#">Twist Fixation Hook, 0.5mm</a><br>Large, 0.5mm, right, clockwise twist hook. Overall length: 127mm.        |   |



## HOOKS

| Item #   | Description   | Image  |
|--|---|--|
| <b>Tyrell Iris Hook</b>  |   |  |
| Straight shaft, 2mm hooked tip, 1 sharp prong. Flat handle. Overall length: 127mm.   |   |  |
| AH2240   | <a href="#">Tyrell Iris Hook</a>  |    |
| <b>University of Kansas Spatula and Hook</b>   |   |  |
| Double-ended, 2mm wide x 24mm long spatula tip, malleable, 3mm wide hooked tip, 90 degree angle. Flat handle. Overall length: 124mm. |   |  |
| AH5360   | <a href="#">University of Kansas Spatula and Hook</a>   |    |
| <b>Green Strabismus Hook</b>   |   |  |
| Straight shaft, 7mm wide tip, flat-ended hook tip. Flat handle. Overall length: 130mm.   |   |  |
| AH0590   | <a href="#">Green Strabismus Hook</a>   |  |
| <b>Jameson Muscle Hook</b>   |   |  |
| Straight shaft, 6mm flat hook with bulbous tip. Flat handle. Overall length: 133mm.  |   |  |
| AH0610   | <a href="#">2mm Muscle Hook</a><br>2mm bulbous tip.   |  |
| AH0620   | <a href="#">1.5mm Muscle Hook</a><br>1.5mm bulbous tip.   |  |
| <b>Von Graefe Strabismus Hook</b>  |   |  |
| Straight shaft, flattened hook tip. Flat handle.   |   |  |
| AH0800   | <a href="#">Von Graefe Strabismus Hook, Size 1</a><br>8mm from hook bend to tip. Overall length: 140mm. |  |

## HOOKS

| Item # | Description   | Image  |
|--------|---|--|
| AH0810 | <b>Von Graefe Strabismus Hook, Size 2</b><br>9mm from hook bend to tip. Overall length: 140mm.  |  |
| AH0820 | <b>Von Graefe Strabismus Hook, Size 3</b><br>10mm from hook bend to tip. Overall length: 143mm. |  |

## RETRACTORS

| Item #  | Description   | Image  |
|---|---|--|
| <b>Berke-Jaeger Lid Plate</b>   |   |  |
| Double-ended stainless steel lid plate, flat with rounded ends, 20mm and 23mm wide blades. Overall length: 109mm. |   |  |
| AL2110  | <b>Berke-Jaeger Lid Plate</b>   |   |
| <b>Conway Lid Retractor</b>   |   |  |
| 7.5mm wide blade, flat handle. Overall length: 142mm.   |   |  |
| AL2155  | <b>Conway Lid Retractor</b>   |  |
| <b>Desmarres Lid Retractor</b>  |   |  |
| Wide retractor blade. Flat, serrated handle with polished finish.   |   |  |
| AL2120  | <b>Desmarres Lid Retractor, Size 0</b><br>11mm wide retractor blade. Overall length: 140mm. |  |
| AL2130  | <b>Desmarres Lid Retractor, Size 1</b><br>13mm wide retractor blade. Overall length: 137mm. |  |
| AL2140  | <b>Desmarres Lid Retractor, Size 2</b><br>15mm wide retractor blade. Overall length: 143mm. |  |
| AL2150  | <b>Desmarres Lid Retractor, Size 3</b><br>17mm wide retractor blade. Overall length: 145mm. |  |

RETRACTORS

| Item # | Description | Image |
|--------|-------------|-------|
|--------|-------------|-------|

**Knapp Lacrimal Sac Retractor**

Blunt 4mm x 8mm wide 4-prong tip. Flat serrated handle with polished finish. Overall length: 135mm.

AL2180 [Knapp Lacrimal Retractor](#)



**Pupil Iris Retractor**

4-prong, intraocular handle, curved.

AL3300 [Pupil Iris Retractor](#)



**Rizzuti Expressor and Iris Retractor**

Double-ended, small retractor blade, 2.5mm wide, muscle hook/lens expressor tip. Round handle. Overall length: 147mm.

AH2210 [Rizzuti Expressor and Iris Retractor](#)



**Schepens Orbital Retractor**



Smooth 14mm x 56mm blade with 4.5mm wide notch in blade. Flat serrated handle. Overall length: 148mm.

AL2210 [Schepens Orbital Retractor](#)



# DSEK Instruments

## DSEK

| Item #   | Description                                      | Image  |
|--|--|--|
| <b>Carlson DSEK Smoother</b>   |  |  |
| Angled shaft, 7.5mm from bend to tip, 2.5mm ball tip. Round handle. Overall length: 115mm.   |  |  |
| AH7200   | <a href="#">DSEK Smoother</a>                    |    |
| <b>Descemet's DSEK/DSAEK Stripper</b>  |  |  |
| Strongly curved shaft, 15mm from bend to tip, T-shaped tip, 0.75mm in diameter. Round handle. Overall length: 114mm.   |  |  |
| AH7220   | <a href="#">DSEK/DSAEK Stripper</a>              |    |
| <b>Rosenwasser Endothelial Stripper</b>  |  |  |
| The Rosenwasser Endothelial Stripper, also known as Melles DSAEK PLK Scraper Style 2, has an angled shaft, 11mm from bend to tip, angled 45 degrees and 90-degree angled sandblasted tip. Round handle. Overall length: 125mm. |  |  |
| AH7202   | <a href="#">Rosenwasser Endothelial Stripper</a> |  |

# Fixation Rings & Picks

**FIXATION RINGS**

| Item #  | Description   | Image |
|---|---|-------|
| <b>Fine-Thornton Fixation Ring</b>  |   |       |
| Swivel style, open ring, with various degree markings on top of ring. Round, knurled handle. Overall length: 133mm. |   |       |
| AR0190  | <b>13mm Fixation Ring</b><br>13mm diameter ring with 10-degree markings on top.           |       |
| AR0190TI  | <b>13mm Fixation Ring</b><br>Titanium. 13mm diameter ring with 10-degree markings on top. |       |
| AR0191  | <b>13mm Fixation Ring</b><br>13mm diameter ring with 15-degree markings on top.           |       |
| AR0197  | <b>14mm Fixation Ring</b><br>14mm diameter ring with 10-degree markings on top.           |       |
| AR0200  | <b>16mm Fixation Ring</b><br>16mm diameter ring with 10-degree markings on top.           |       |

**Flieringa Scleral Fixation Ring**

Flieringa Scleral Fixation Rings are stainless steel with a polished finish. Various sizes ranging from 12mm to 23mm. Sets are available.

|           |   |  |
|-----------|---|--|
| AM0330 12 | <b>12mm Scleral Fixation Ring</b><br>Stainless steel scleral fixation ring set. 12mm in diameter.   |  |
| AM0330 13 | <b>13mm Scleral Fixation Ring</b><br>Stainless steel scleral fixation ring set. 13mm in diameter.   |  |
| AM0330 14 | <b>14mm Scleral Fixation Ring</b><br>Stainless steel scleral fixation ring set. 14mm in diameter.   |  |
| AM0330 15 | <b>15mm Scleral Fixation Ring</b><br>Stainless steel scleral fixation ring set. 15mm in diameter.   |  |
| AM0330 16 | <b>16mm Scleral Fixation Ring</b><br>Stainless steel scleral fixation ring set. 16mm in diameter.   |  |
| AM0330 17 | <b>17mm Scleral Fixation Ring</b><br>Stainless steel scleral fixation ring set. 17mm in diameter.   |  |
| AM0330 18 | <b>18mm Scleral Fixation Ring</b><br>Stainless steel scleral fixation ring set. 18mm in diameter.   |  |
| AM0330 19 | <b>19mm Scleral Fixation Ring</b><br>Stainless steel scleral fixation ring set. 19mm in diameter.   |  |
| AM0330 20 | <b>20mm Scleral Fixation Ring</b><br>Stainless steel scleral fixation ring set. 20mm in diameter.   |  |
| AM0330 21 | <b>21mm Scleral Fixation Ring</b><br>Stainless steel scleral fixation ring set. 21mm in diameter.   |  |
| AM0330 22 | <b>22mm Scleral Fixation Ring</b><br>Stainless steel scleral fixation ring set. 22mm in diameter.   |  |
| AM0330 23 | <b>23mm Scleral Fixation Ring</b><br>Stainless steel scleral fixation ring set. 23mm in diameter.   |  |
| AM0330    | <b>Set of 8 Scleral Fixation Rings</b><br>Stainless steel scleral fixation ring set. This set includes 8 different sized rings that increase in 1.0mm increments. Diameter sizes include: 16mm, 17mm, 18mm, 19mm, 20mm, 21mm, 22mm, and 23mm. |  |



**FIXATION RINGS**

| Item #     | Description   | Image |
|------------|---|-------|
| AM0330 SET | <p><b>Set of 12 Scleral Fixation Rings</b></p> <p>Stainless steel scleral fixation ring set. This set includes 12 different sized rings that increase in 1.0mm increments. Diameter sizes include: 12mm, 13mm, 14mm, 15mm 16mm, 17mm, 18mm, 19mm, 20mm, 21mm, 22mm, and 23mm.</p> |       |

**Globe Fixation Ring**

Fixed style, open ring. 16mm diameter. Concentric grooves on the bottom of ring for fixation of globe. Round handle. Overall length: 133mm.

|        |                            |  |
|--------|----------------------------|--|
| AR0395 | <b>Globe Fixation Ring</b> |  |
|--------|----------------------------|--|

**Thornton Fixation Ring**

Fixed style. Overall length: 133mm.



|        |   |   |
|--------|---|---|
| AR0430 | <p><b>Thornton Fixation Ring, Open</b></p> <p>Open ring. 13mm diameter with 7mm opening. Flat handle.</p> |  |
|--------|---|---|

|        |   |  |
|--------|---|--|
| AR0420 | <p><b>Thornton Fixation Ring, Closed</b></p> <p>Closed ring. 16mm diameter. Round handle.</p> |  |
|--------|---|--|

**FIXATION PICKS**

| Item #  | Description                             | Image  |
|---|---|--|
| <b>Anis Scleral Twist Fixation Cone</b>                 |   |  |
| Straight shaft, cone with 2.5mm diameter. Round handle. |   |  |
| AH0510  | <b>Anis Scleral Twist Fixation Cone</b> |  |

## FIXATION PICKS

| Item #                     | Description   | Image   |
|----------------------------|---|---|
| <b>Burch Fixation Pick</b> | Straight shaft, dual pronged tips, sharp tipped, 3.0mm apart. Flat handle. Overall length: 131mm. |  |
| AH0520                     | <a href="#">Burch Fixation Pick</a>   |   |

# Forceps & Clamps

**CAPSULE FORCEPS**

| Item # | Description | Image |
|--------|-------------|-------|
|--------|-------------|-------|

**Arruga Capsule Forceps**

Vaulted shafts, narrow cup jaws. Flat handle. Overall length: 101mm.

|        |   |
|--------|---|
| AF0215 | <a href="#">Arruga Capsule Forceps, Curved</a><br>2.0mm cup jaws. |
|--------|---|

|        |   |
|--------|---|
| AF0210 | <a href="#">Arruga Capsule Forceps, Curved</a><br>2.5mm cup jaws. |
|--------|---|



**Castroviejo Capsule Forceps**

Vaulted, cross-action shafts with 2.5mm cup jaws. Flat handle. Overall length: 105mm.

|        |   |
|--------|---|
| AF0230 | <a href="#">Castroviejo Capsule Forceps</a> |
|--------|---|



**Gaskin Fragment Forceps**

Angled shafts, 11mm from bend to tip, smooth jaws. Flat handle. Overall length: 108mm.

|        |   |
|--------|---|
| AF6395 | <a href="#">Gaskin Fragment Forceps</a> |
|--------|---|



**Kraff Capsule Tag Forceps**

Angled shafts, 11mm long jaws with 1.5mm smooth platform. Flat, 3-hole handle. Overall length: 108mm.

|        |   |
|--------|---|
| AF0250 | <a href="#">Kraff Capsule Tag Forceps</a> |
|--------|---|



**CAPSULORHEXIS FORCEPS**

| Item # | Description | Image |
|--------|-------------|-------|
|--------|-------------|-------|

**Devgan MICS Capsulorhexis Forceps**

Vaulted cross-action shafts. Marks on top of shafts at 2.5mm and 5mm. Very fine Utrata style tips. Round handle. Overall length: 119mm.

AF0365T [Devgan MICS Capsulorhexis Forceps](#)



**Gianetti MICS Capsulorhexis Forceps**

Vaulted thin shanks, 1.5mm maximum tip spread, extremely small delicate tips. Round handle. Overall length: 101mm.

AF0292 [Gianetti MICS Capsulorhexis Forceps](#)



**Gimbel Capsulorhexis Forceps**

Angled shafts, 12mm from bend to tip. Fine, serrated grasping tips, jaws set to open only 3mm. Light tension. Flat handle. Overall length: 80mm.

AF0295 [Gimbel Capsulorhexis Forceps](#)



**Kellan Capsulorhexis Forceps**

Angled shafts, 11mm from bend to tip at 45 Degrees with Arruga style tips. Round knurled handle with guide pin. Overall length: 100mm.

AF0288 [Kellan Capsulorhexis Forceps](#)





**Lehner-Utrata Capsulorhexis Forceps**

Vaulted shafts, 12mm from bend to tip, delicate grasping tips. Flat handle. Overall length: 82mm.







AF0300 C [Lehner-Utrata Capsulorhexis Forceps](#)





**CAPSULORHEXIS FORCEPS**

| Item #   | Description  | Image   |
|--|--|---|
| <b>Masket Capsulorhexis Forceps</b>  |  |   |
| Vaulted 11mm shafts, very delicate triangular tips for grasping capsule. Flat handle. Overall length: 101mm.           |  |   |
| AF0340   | <a href="#">Masket Capsulorhexis Forceps</a>   |  <p>The image shows the Masket Capsulorhexis Forceps, which has two long, vaulted shafts with delicate triangular tips. The handle is flat and features a textured grip section. An inset image in the top right corner provides a magnified view of the fine, triangular tips.</p>   |
| <b>Nevyas Capsulorhexis Forceps</b>  |  |   |
| Angled shafts, 12mm from bend to tip. Cystotome shaped tip for puncturing capsule. Flat handle. Overall length: 104mm. |  |   |
| AF0530   | <a href="#">Nevyas Capsulorhexis Forceps</a>   |  <p>The image shows the Nevyas Capsulorhexis Forceps, featuring two angled shafts that meet at a point. The tips are finely serrated and have a cystotome shape. The handle is flat with three circular holes for grip. The overall length is 104mm.</p>  |
| <b>O’Gawa-Utrata Capsulorhexis Forceps</b>   |  |   |
| Angled shafts, 12mm from bend to tip. Fine, serrated tips for grasping capsule. Round handle. Overall length: 98mm.    |  |   |
| AF0355   | <a href="#">O’Gawa-Utrata Capsulorhexis Forceps</a>  |  <p>The image shows the O’Gawa-Utrata Capsulorhexis Forceps, which has two angled shafts with fine, serrated tips. The handle is round and textured. The overall length is 98mm.</p>  |
| <b>Utrata Capsulorhexis Forceps</b>  |  |   |
| Angled and vaulted shafts, serrated and triangular tips for grasping capsule.  |  |   |
| AF0290   | <p><a href="#">Utrata Capsulorhexis Forceps, Angled</a></p> <p>Angled shafts, 12mm bend from tip. Fine, serrated tips for grasping capsule. Flat handle. Overall length: 82mm.</p>         |  <p>The image shows the Utrata Capsulorhexis Forceps, Angled version (AF0290). It features two angled and vaulted shafts with serrated and triangular tips. The handle is flat with a textured grip. An inset image in the top right corner shows a magnified view of the tips.</p>                                       |
| AF0290 A   | <p><a href="#">Utrata Capsulorhexis Forceps, Angled</a></p> <p>Angled shafts, 12mm bend from tip. Fine, serrated tips for grasping capsule. Flat handle. Overall length: 80mm.</p>         |  <p>The image shows the Utrata Capsulorhexis Forceps, Angled version (AF0290 A). It has two angled shafts with serrated tips. The handle is flat with a textured grip and three circular holes. An inset image in the top right corner shows a magnified view of the tips. The handle is labeled 'ACCUHOME AF0290 A'.</p> |
| AF0290K  | <p><a href="#">Utrata Capsulorhexis Forceps, Angled</a></p> <p>Angled shafts, 12mm bend from tip. Fine, serrated tips for grasping capsule. Flat, 3-hole handle. Overall length: 82mm.</p> |  <p>The image shows the Utrata Capsulorhexis Forceps, Angled version (AF0290K). It features two angled shafts with serrated tips. The handle is flat with a textured grip and three circular holes. An inset image in the top right corner shows a magnified view of the tips. The handle is labeled 'AF0290K'.</p>       |





CAPSULORHEXIS FORCEPS

| Item #    | Description  | Image  |
|-----------|--|--|
| AF0290TI  | <p><b>Utrata Capsulorhexis Forceps, Angled</b></p> <p>Titanium. Angled shafts, 11mm bend from tip. Fine, serrated tips for grasping capsule. Flat handle. Overall length: 82mm.</p>          |    |
| AF0299    | <p><b>Utrata Capsulorhexis Forceps, Angled</b></p> <p>Angled shafts, 12mm bend from tip. Fine, sharp serrated tips for grasping capsule. Flat handle. Overall length 82mm.</p>               |    |
| AF0300    | <p><b>Utrata Capsulorhexis Forceps, Angled</b></p> <p>Angled shafts, 12mm bend from tip. Fine, serrated tips for grasping capsule. Round handle. Overall length: 98mm.</p>                   |    |
| AF0300TI  | <p><b>Utrata Capsulorhexis Forceps, Angled</b></p> <p>Titanium. Angled shafts, 12mm bend from tip. Fine, serrated tips for grasping capsule. Round handle. Overall length: 98mm.</p>         |   |
| AF0310    | <p><b>Utrata Capsulorhexis Forceps, Vaulted</b></p> <p>Vaulted shafts. Fine, serrated tips for grasping capsule. Round handle. Overall length: 98mm.</p>                                     |  |
| AF0310TI  | <p><b>Utrata Capsulorhexis Forceps, Vaulted</b></p> <p>Titanium. Vaulted shafts. Fine, serrated tips for grasping capsule. Round handle. Overall length: 98mm.</p>                           |  |
| AF0350    | <p><b>Utrata Capsulorhexis Forceps, Vaulted</b></p> <p>Vaulted shafts, 12mm bend from tip. Fine, serrated tips for grasping capsule. Cross-action handle. Overall length: 116mm.</p>         |  |
| AF0290K T | <p><b>Utrata Capsulorhexis Forceps, Angled</b></p> <p>Titanium. Angled shafts, 12mm bend from tip. Fine, serrated tips for grasping capsule. Flat, 3-hole handle. Overall length: 101mm.</p> |  |

**CAPSULORHEXIS FORCEPS**

| Item #  | Description  | Image   |
|---|--|---|
| AF0290L   | <p><b>Utrata Capsulorhexis Forceps, Angled</b></p> <p>Angled shafts, 12mm from bend to tip, delicate, triangular tips, laser marks on shaft at 2.5mm and 5.0mm. Short, flat 3-hole handle. Overall length: 89mm.</p> |   |
| <p><b>Utrata MICS Capsulorhexis Forceps</b></p> <p>Angled shafts, 12mm from bend to tip. Fine, serrated tips for grasping capsule. 1.8mm maximum blade spread. Flat handle. Overall length: 81mm.</p> |  |   |
| AF0290M   | <p><b>Stainless Steel Capsulorhexis Forceps</b></p> <p>Stainless steel.</p>  |  |
| AF0290M T   | <p><b>Titanium Capsulorhexis Forceps</b></p> <p>Titanium.</p>  |   |

**CHALAZION FORCEPS**

| Item #   | Description  | Image  |
|--|--|--|
| <p><b>Baird Chalazion Forceps</b></p> <p>Oval 13mm solid lower plate, 12mm x 8mm open upper plate, locking thumb screw. Flat handle. Overall length: 97mm.</p> |  |  |
| AF0400   | <p><b>Baird Chalazion Forceps</b></p>  |  |
| <p><b>Desmarres Chalazion Forceps</b></p> <p>Solid lower plate with open upper plate, locking thumb screw. Flat handle. Overall length: 89mm.</p>              |  |  |
| AF0410   | <p><b>Desmarres Chalazion Forceps, 24mm</b></p> <p>24mm solid lower plate, 12mm x 17mm open upper plate.</p> |  |
| AF0411   | <p><b>Desmarres Chalazion Forceps, 30mm</b></p> <p>30mm solid lower plate, 12mm x 20mm open upper plate.</p> |  |
| <p><b>Francis Chalazion Forceps</b></p> <p>17mm lower plate, 12mm x 14mm upper plate, cross-action flat handle. Overall length: 98mm.</p>                      |  |  |
| AF0430   | <p><b>Francis Chalazion Forceps</b></p>  |  |



**CHALAZION FORCEPS**

| Item # | Description | Image |
|--------|-------------|-------|
|--------|-------------|-------|

**Heath Chalazion Forceps**

Solid oval lower plate, 12mm x 14mm open upper plate, locking thumb screw. Flat handle. Overall length: 98mm.

|        |   |
|--------|---|
| AF0440 | <a href="#">Heath Chalazion Forceps</a> |
|--------|---|



**Hunt Chalazion Forceps**

Solid round lower plate, 12mm open upper plate, locking thumb screw, flat handle. Overall length: 98mm.

|        |  |
|--------|--|
| AF0450 | <a href="#">Hunt Chalazion Forceps</a> |
|--------|--|



**Lambert Chalazion Forceps**

Solid round lower plate, open upper plate, locking thumb screw. Flat handle. Overall length: 92mm.

|        |  |
|--------|--|
| AF0460 | <a href="#">Lambert Chalazion Forceps, Large</a><br>Large, solid round lower plate, 15mm open upper plate. |
|--------|--|



|        |   |
|--------|---|
| AF0470 | <a href="#">Lambert Chalazion Forceps, Small</a><br>Small, solid round lower plate, 8.0mm open upper plate. |
|--------|---|



**Wies Chalazion Forceps**

15mm solid lower plate with 9mm x 12mm open serrated upper plate, locking thumb screw, flat handle.

|        |  |
|--------|--|
| AF0520 | <a href="#">Wies Chalazion Forceps</a> |
|--------|--|



CILIA FORCEPS

| Item # | Description | Image |
|--------|-------------|-------|
|--------|-------------|-------|

**Barraquer Cilia Forceps**

Slightly angled shafts, 6mm smooth platform tips. Overall length: 111mm.

|        |  |
|--------|--|
| AF0800 | <b>Flat Handle Forceps</b><br>Flat handle. |
|--------|--|



|        |  |
|--------|--|
| AF0801 | <b>3-Hole Handle Forceps</b><br>Flat, 3-hole handle. |
|--------|--|



**Cilia Forceps**

Straight shafts, 1.0mm x 3.0mm smooth platform tips. Flat handle. Overall length: 75mm.

|        |                      |
|--------|----------------------|
| AF0810 | <b>Cilia Forceps</b> |
|--------|----------------------|



**Drews Cilia Forceps**

Straight, narrow shafts with 7mm long smooth platform. Flat handle. Overall length: 105mm.

|        |                            |
|--------|----------------------------|
| AF0820 | <b>Drews Cilia Forceps</b> |
|--------|----------------------------|



**Gradle Cilia Forceps**

Straight shafts, 2mm fine tips. Flat, cross-action handle. Overall length: 95mm.



|        |                             |
|--------|-----------------------------|
| AF0830 | <b>Gradle Cilia Forceps</b> |
|--------|-----------------------------|



CILIA FORCEPS

| Item #   | Description                                    | Image  |
|--|--|--|
| <b>Swiss Cilia and Suture Forceps</b>  |  |  |
| Straight shafts, 45-degree 3mm wide jaws. Flat handle. Overall length: 95mm. |  |  |
| AF0840   | <a href="#">Swiss Cilia and Suture Forceps</a> |  |

CORNEAL FORCEPS

| Item #   | Description   | Image  |
|--|---|--|
| <b>Castroviejo Colibri Corneal Forceps</b>   |   |  |
| Curved shafts, 0.12mm 1 x 2 teeth set at 45 degrees, 6mm tying platform. Flat, wide handle. Overall length: 108mm. |   |  |
| AF1110   | <a href="#">Stainless Steel Forceps</a><br>Stainless steel.           |   |
| AF1110T  | <a href="#">Titanium Forceps</a><br>Titanium.                         |  |
| <b>Girard Corneoscleral Forceps</b>  |   |  |
| Curved shafts, 1 x 2 teeth set at 90 degrees, 6mm tying platform. Round handle. Overall length: 108mm.             |   |  |
| AF1150   | <a href="#">Scleral Forceps, Right</a><br>Right-hand use, 0.12mm tip. |  |
| AF1160   | <a href="#">Scleral Forceps, Left</a><br>Left-hand use, 0.12mm tip.   |  |
| AF1170   | <a href="#">Scleral Forceps, Left</a><br>Left-hand use, 0.3mm tip.    |  |

**CORNEAL FORCEPS**

| Item # | Description | Image |
|--------|-------------|-------|
|--------|-------------|-------|

**Hyde Corneal Forceps**

Curved shafts, 0.12mm 2 x 2 teeth set at 45 degrees, 6mm tying platform. Flat handle. Overall length: 108mm.

AF1190 [Hyde Corneal Forceps](#)



**Katzin-Barraquer Colibri Corneal Utility Forceps**

Colibri style. 0.4mm 1 x 2 teeth set at 90 degrees, with 6mm tying platform. Overall length: 73mm.

AF1185 [Corneal Utility Forceps](#)



**Pierse Colibri Corneal Forceps**

Very delicate 0.11mm 1 x 1 Pierse-type teeth, flat handle. Overall length: 76mm.

AF1240 [Pierse Colibri Corneal Forceps](#)



**Polack Colibri Corneal Forceps**

Colibri style. Double 0.12mm 1 x 2 teeth separated by 1.0mm and 2.75mm long. Overall length: 70mm.

AF1250 [Polack Colibri Corneal Forceps](#)



**Thorpe Corneal Forceps**

Straight shafts, 0.12mm 2 x 3 teeth set at 45 degrees, with 5mm tying platform. Flat handle. Overall length: 94mm.



AF1270 [Thorpe Corneal Forceps](#)



**CORNEAL FORCEPS**

| Item #  | Description   | Image  |
|---|---|--|
| <b>Troutman-Barraquer Colibri Corneal Forceps</b>   |   |  |
| Colibri style corneal forceps that are available in both stainless steel and titanium options. Forceps have curved shafts and various tip sizes with 1 x 2 teeth sets. Flat handle. Overall length: 76mm. |   |  |
| AFI295  | <b>0.3mm Corneal Forceps</b><br>0.3mm teeth set at 90 degrees, 6mm tying platform.                        |  |
| AFI280  | <b>0.5mm Corneal Forceps</b><br>0.5mm teeth set at 45 degrees.  |  |
| AFI180  | <b>0.12mm Corneal Forceps</b><br>0.12mm teeth set at 45 degrees, 4.5mm tying platform.                    |  |
| AFI180TI  | <b>0.12mm Titanium Corneal Forceps</b><br>Titanium, 0.12mm teeth set at 45 degrees, 4.5mm tying platform. |  |
| AFI290  | <b>0.12mm Corneal Forceps</b><br>0.12mm set at 90 degrees.  |  |
| AFI290TI  | <b>0.12mm Titanium Corneal Forceps</b><br>Titanium. 0.12mm teeth set at 90 degrees.                       |  |

**DSEK FORCEPS**

| Item #   | Description                       | Image  |
|--|-----------------------------------|--|
| <b>Charlie II Donor Forceps</b>  |                                   |  |
| Titanium. Very delicate, angled shafts, extremely thin semi-pointed tips. When tips are closed, there is a 150 micron (0.15mm) gap to keep from cell damage. Round knurled handle with guide pin. Overall length: 105mm. |                                   |  |
| AF0285T  | <b>Charlie Donor Forceps</b>      |  |
| <b>Rossenwasser Donor Lamella Forceps</b>  |                                   |  |
| Angled/vaulted shafts, 12mm from bend to tip with 2mm thin semi-pointed tips. When tips are closed there is a 150 micron (0.15mm) gap to keep from cell damage. Flat, 3-hole handle. Overall length: 102mm.              |                                   |  |
| AF0286   | <b>Rossenwasser Donor Lamella</b> |  |

DSEK FORCEPS

| Item # | Description | Image |
|--------|-------------|-------|
|--------|-------------|-------|

**Snyder Stripping Forceps**

Angled shafts, 12mm from bend to tip. Tips pointed upward for grasping of Descemet's Membrane. Flat handle. Overall length: 83mm.

|        |                                   |  |
|--------|-----------------------------------|--|
| AF0291 | <a href="#">Stripping Forceps</a> |  |
|--------|-----------------------------------|--|

DRESSING FORCEPS

| Item # | Description | Image |
|--------|-------------|-------|
|--------|-------------|-------|

**Bishop-Harmon Dressing Forceps**

Straight shafts, 0.6mm cross-serrated tips. Flat, 3-hole handle. Overall length: 82mm.

|        |  |   |
|--------|--|---|
| AF2100 | <a href="#">Bishop-Harmon Dressing Forceps</a> |  |
|--------|--|---|

**Dressing Forceps**

Straight and curved shafts, 11mm serrated tips. Flat handle. Overall length: 98mm.

|        |  |  |
|--------|--|--|
| AF2110 | <a href="#">Dressing Forceps, Curved</a><br>Heavy, slightly curved shafts. |  |
|--------|--|--|

|        |   |  |
|--------|---|--|
| AF2120 | <a href="#">Dressing Forceps, Curved</a><br>Delicate, strong curved shafts. |  |
|--------|---|--|

|        |  |  |
|--------|--|--|
| AF2140 | <a href="#">Dressing Forceps, Straight</a><br>Delicate, straight shafts. |  |
|--------|--|--|

|        |   |  |
|--------|---|--|
| AF2130 | <a href="#">Dressing Forceps, Curved</a><br>Delicate, slightly curved shafts. |  |
|--------|---|--|

**DRESSING FORCEPS**

| Item # | Description  | Image   |
|--------|--|---|
| AF2150 | <b>Dressing Forceps, Straight</b><br>Heavy, straight shafts. | A pair of straight dressing forceps with a wide, serrated handle and long, straight shafts. An inset image shows a close-up of the serrated handle. |

**FEMTOSECOND FORCEPS**

| Item #  | Description                          | Image  |
|---|--------------------------------------|--|
| <b>Femto LRI Enhancement Forceps</b>  |                                      |  |
| Cross-action handle with 1.0mm paddles designed to open femtosecond cataract incisions. |                                      |  |
| AF6178  | <b>Femto LRI Enhancement Forceps</b> | A pair of femtosecond forceps with a cross-action handle and two long, thin paddles. An inset image shows a close-up of the paddles. |

**FIXATION FORCEPS**

| Item #   | Description                         | Image  |
|--|-------------------------------------|--|
| <b>Castroviejo Fixation Forceps</b>  |                                     |  |
| Straight shafts, 0.3mm 1 x 2 teeth, without platforms, wide serrated flat handle. Overall length: 111mm. |                                     |  |
| AF2320   | <b>Castroviejo Fixation Forceps</b> | A pair of fixation forceps with a wide, serrated handle and two long, straight shafts. An inset image shows a close-up of the teeth on the shafts. |

| Item #   | Description                         | Image   |
|--|-------------------------------------|---|
| <b>Fechtner Conjunctiva Forceps</b>  |                                     |   |
| Straight shafts, delicate ring tips with tying platform. Flat, 3-hole handle. Overall length: 101mm. |                                     |   |
| AF1115   | <b>Fechtner Conjunctiva Forceps</b> | A pair of conjunctiva forceps with a flat, three-hole handle and two long, straight shafts with delicate ring tips. An inset image shows a close-up of the ring tips. |

**FIXATION FORCEPS**

| Item # | Description | Image |
|--------|-------------|-------|
|--------|-------------|-------|

**Graefe Fixation Forceps**

Straight shafts, jaws with fine teeth. Flat handle. Overall length: 111mm.

|        |  |
|--------|--|
| AF2360 | <b>4.5mm Graefe Fixation Forceps</b><br>4.5mm wide jaws.                       |
| AF2370 | <b>3.5mm Graefe Fixation Forceps</b><br>3.5mm wide jaws.                       |
| AF2380 | <b>4.5mm Graefe Fixation Forceps</b><br>4.5mm wide jaws, fine teeth with lock. |



**Green Fixation Forceps**

Straight shafts, 10mm wide jaws with teeth. Flat handle. Overall length: 98mm.

|        |                               |
|--------|-------------------------------|
| AF2395 | <b>Green Fixation Forceps</b> |
|--------|-------------------------------|



**Kremer Corneal Fixation Forceps**

Angled shafts, U-shaped double 0.12mm 1 x 2 teeth, separated 13.0mm, with lock. Flat handle. Overall length: 105mm.

|        |  |
|--------|--|
| AF2400 | <b>Kremer Corneal Fixation Forceps</b> |
|--------|--|



**Lester Fixation Forceps**

Straight shafts, fine 2 x 3 teeth set at 90 degrees, flat handle. Overall length: 95mm.

|        |                                |
|--------|--------------------------------|
| AF2440 | <b>Lester Fixation Forceps</b> |
|--------|--------------------------------|



**McGregor Conjunctiva Forceps**

Straight shafts, 6mm tying platform. Flat handle: Overall length: 108mm.

|        |                                     |
|--------|-------------------------------------|
| AF6950 | <b>McGregor Conjunctiva Forceps</b> |
|--------|-------------------------------------|





**FIXATION FORCEPS**

| Item #   | Description                                     | Image  |
|--|---|--|
| <b>Moody Fixation Forceps</b>  |   |  |
| Curved, 0.5mm 1 x 2 teeth, with lock. Flat handle. Overall length: 86mm. |   |  |
| AF2450   | <b>Fixation Forceps, Left</b><br>Curved left.   |  |
| AF2451   | <b>Fixation Forceps, Right</b><br>Curved right. |  |



|   |                               |  |
|---|-------------------------------|--|
| <b>Osher Fixation Forceps</b>   |                               |  |
| 0.12mm Elschmig 1 x 2 teeth, delicate tying platform, wide serrated flat handle. Overall length: 105mm. |                               |  |
| AF0600  | <b>Osher Fixation Forceps</b> |  |

|   |                                   |  |
|---|-----------------------------------|--|
| <b>Thorpe Conjunctiva Forceps</b>   |                                   |  |
| Straight shafts, 2 x 3 teeth set at 90 degrees and tying platform. Flat handle: Overall length: 94mm. |                                   |  |
| AF2540  | <b>Thorpe Conjunctiva Forceps</b> |  |

**HEMOSTATIC FORCEPS**

| Item #  | Description  | Image  |
|---|--|--|
| <b>Hemostatic Forceps</b>   |  |  |
| Stainless steel hemostatic forceps that are available with both straight and curved serrated jaws. All handles have a ratchet lock with ring handles and dull finish. |  |  |
| AF4100  | <b>Curved Hemostatic Forceps</b><br>Curved, 22mm serrated jaws. Overall length: 99mm.      |  |
| AF4110  | <b>Straight Hemostatic Forceps</b><br>Straight, 22mm serrated jaws. Overall length: 127mm. |  |

**HEMOSTATIC FORCEPS**

| Item # | Description   | Image  |
|--------|---|--|
| AF4120 | <b>Curved Hemostatic Forceps</b><br>Curved, 20mm serrated jaws. Overall length: 99mm.     |  |
| AF4130 | <b>Straight Hemostatic Forceps</b><br>Straight, 20mm serrated jaws. Overall length: 99mm. |  |

**Kelly Hemostatic Forceps**

Straight and curved shafts with serrated jaws. Ring handle. Overall length: 140mm.

|        |  |  |
|--------|--|--|
| AF0700 | <b>Kelly Forceps, Straight</b><br>Straight shafts. |   |
| AF0750 | <b>Kelly Forceps, Curved</b><br>Curved shafts.     |  |

**Sponge Forceps**

Straight shafts, serrated jaws. Ring handle. Overall length: 178mm.

|        |                       |  |
|--------|-----------------------|--|
| AF9075 | <b>Sponge Forceps</b> |  |
|--------|-----------------------|--|

IOL FORCEPS

| Item # | Description | Image |
|--------|-------------|-------|
|--------|-------------|-------|

**Accutome Folding Forceps**

Angled, cross-action shafts. Cradle jaws. Flat handle. Overall length: 97mm.

AF2405 [Accutome Folding Forceps](#)



**Faulkner Lens Holding Forceps**

Angled shafts, round smooth polished jaws. Flat, 3-hole handle. Overall length: 114mm.

AF3150 [Faulkner Lens Holding Forceps](#)



**Haberle-McPherson Lens Holding Forceps**

Angled shafts, 7.5mm smooth jaws with diagonal groove in tip. Flat, 3-hole handle.

AF3480 [Haberle-McPherson Lens Holding Forceps](#)



**Implant Removal Forceps**

Angled, cross-action, thin shafts. Tooth in top jaw with grooves in bottom jaw. Designed to grasp the lens optic or lens segment to efficiently remove from the anterior chamber. Overall length: 120mm.

AF3305 [Implant Removal Forceps](#)



**IOL Lens Loading Forceps**

Designed for loading AcrySoft IOL into Monarch II and III Cartridges.

AF8000 [IOL Lens Loading Forceps](#)



IOL FORCEPS

| Item # | Description | Image |
|--------|-------------|-------|
|--------|-------------|-------|

**Accutome IOL Lens Loading Forceps**

Straight shafts, with smooth, flat jaws. Flat handle.

|        |   |
|--------|---|
| AF3345 | <a href="#">Accutome IOL Lens Loading Forceps</a> |
|--------|---|



**Livernois IOL Folding Forceps**

Angled shafts, concave jaw surface. Flat, 3-hole handle.

|        |   |
|--------|---|
| AF3225 | <a href="#">Livernois IOL Folding Forceps</a> |
|--------|---|



**Livernois IOL Holding Forceps**

Livernois IOL Holding Forceps are available in both angled and straight shafts. Rounded jaws that are to be used on soft IOLs. Flat, 3-hole handle. Overall length: 108mm.

|        |   |
|--------|---|
| AF3230 | <a href="#">IOL Forceps, Angled</a><br>Angled shafts. |
|--------|---|



|        |   |
|--------|---|
| AF3240 | <a href="#">IOL Forceps, Straight</a><br>Straight shafts. |
|--------|---|





**Steinert Folding Forceps**

Angled shafts. Flat handle. Overall length: 108mm.





|        |  |
|--------|--|
| AF3390 | <a href="#">Steinert Folding Forceps</a> |
|--------|--|





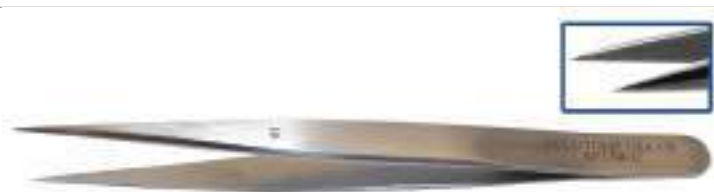

IOL FORCEPS

| Item #   | Description   | Image  |
|--|---|--|
| <b>Universal II IOL Insertion Forceps</b>  |   |  |
| Titanium. Cross-action shafts for small incision insertion of second generation foldable IOLs, petite tips, with lock. For thin silicone IOLs. |   |  |
| AF3360   | <a href="#">Universal II IOL Insertion Forceps</a>  |  |
| <b>Universal III IOL Insertion Forceps</b>   |   |  |
| Titanium. Cross-action shafts for small incision insertion of third generation foldable IOLs, petite tips, with lock. For thin acrylic IOLs.   |   |  |
| AF3370   | <a href="#">Universal III IOL Insertion Forceps</a> |  |

JEWELER FORCEPS

| Item #  | Description  | Image  |
|---|--|--|
| <b>Jeweler Forceps</b>  |  |  |
| Straight, angled, and curved shafts with fine pointed tips. Smooth handle with dull finish. |  |  |
| AF3700  | <a href="#">Jewelers Type Forceps #1</a><br>Straight shafts with fine pointed tips. Overall length: 120mm.         |  |
| AF3705  | <a href="#">Jewelers Type Forceps #2</a><br>Straight shafts with strong, fine pointed tips. Overall length: 120mm. |  |
| AF3710  | <a href="#">Jewelers Type Forceps #3</a><br>Straight shafts with extra fine pointed tips. Overall length: 120mm.   |  |
| AF3720  | <a href="#">Jewelers Type Forceps #3-C</a><br>Straight shafts with extra fine pointed tips. Overall length: 110mm. |  |

JEWELER FORCEPS

| Item # | Description   | Image   |
|--------|---|---|
| AF3730 | <p><b>Jewelers Type Forceps #4</b></p> <p>Straight and narrow shafts with extra fine pointed tips. Overall length: 110mm.</p> |   |
| AF3740 | <p><b>Jewelers Type Forceps #5/45</b></p> <p>Angled shafts with extra fine pointed tips. Overall length: 120mm.</p>           |   |
| AF3750 | <p><b>Jewelers Type Forceps #5</b></p> <p>Straight, narrow shafts with extra fine pointed tips. Overall length: 120mm.</p>    |   |
| AF3760 | <p><b>Jewelers Type Forceps #7</b></p> <p>Curved shafts with extra fine pointed tips. Overall length: 111mm.</p>              |  |

Suture Removal Forceps

Slightly angled shafts, very fine pointed tips with textured jaws. Smooth, flat handle with dull finish. For wet suture removal. Overall length: 120mm.



|        |                                      |  |
|--------|--------------------------------------|--|
| AF3775 | <p><b>Suture Removal Forceps</b></p> |  |
|--------|--------------------------------------|--|

Jeweler's Type Utility and Splinter Forceps



Short pointed jaws, flat handle. Overall length: 92mm.

|        |  |  |
|--------|--|--|
| AF3765 | <p><b>Utility and Splinter Forceps</b></p> |  |
|--------|--|--|

LASIK FORCEPS

| Item #  | Description   | Image  |
|---|---|--|
| <b>Buratto LASIK Flap Forceps</b>                 |   |  |
| Angled and curved shafts with various tip styles. |   |  |
| AF3355TI  | <p><b>Titanium Buratto LASIK Flap Forceps</b></p> <p>Titanium. Angled shafts, curved inward tips, 8mm from bend to tip, 0.5mm blunt round tips. Flat handle. Overall length: 104mm.</p> |  |
| AF3600  | <p><b>Stainless Steel Buratto LASIK Flap Forceps</b></p> <p>Curved shafts, 0.8mm very delicate disc-shaped tip with serrated jaws. Flat, 3-hole handle. Overall length: 102mm.</p>      |  |

MUSCLE FORCEPS

| Item #   | Description   | Image  |
|--|---|--|
| <b>Berke Ptosis Forceps</b>  |   |  |
| Berke Ptosis Forceps have a curved tip with straight, longitudinal serrated blades. Flat, serrated handle with slide lock. Available in 20mm or 27mm jaw length. |   |  |
| AF4320   | <p><b>Ptosis Forceps, 20mm</b></p> <p>20mm jaw length. Overall length: 98mm.</p>  |  |
| AF4310   | <p><b>Ptosis Forceps, 27mm</b></p> <p>27mm jaw length. Overall length: 104mm.</p> |  |
| <b>Putterman Muscle Forceps</b>  |   |  |
| Titanium. Three pins and holes on each 22mm paddle. Overall length: 95mm.  |   |  |
| AF9050TI   | <p><b>Putterman Muscle Forceps</b></p>  |  |
| <b>Troutman Superior Rectus Forceps</b>  |   |  |
| Angled shafts bent 10mm from tip. 1 x 2 teeth. Wide serrated handle. Overall length: 108mm.  |   |  |
| AF4400   | <p><b>Troutman Superior Rectus Forceps</b></p>                                    |  |

**PRE-CHOPPER FORCEPS**

| Item # | Description | Image |
|--------|-------------|-------|
|--------|-------------|-------|

**Akahoshi PreChop Forceps**

Akahoshi PreChop forceps with straight and angled shafts used for nucleus fragmentation. Cross-action jaws open 3mm wide, extra-pointed tip. Round handle. Overall length: 120mm.

|        |  |  |
|--------|--|--|
| AF7600 | <p><b>PreChop Forceps, Straight</b><br/>Straight shafts.</p> |  |
|--------|--|--|



|        |  |  |
|--------|--|--|
| AF7610 | <p><b>PreChop Forceps, Angled</b><br/>Angled shafts.</p> |  |
|--------|--|--|



|          |  |  |
|----------|--|--|
| AF7640TI | <p><b>PreChop Forceps, Straight</b><br/>Titanium. Straight shafts.</p> |  |
|----------|--|--|



**D&K Salvitti Akahoshi PreChopping Forceps**

Straight shafts, reverse cross action. Fits through a 1.7mm incision and spreads 2.5mm wide. Round handle. Overall length: 124mm.

|        |   |  |
|--------|---|--|
| AF7635 | <p><b>Salvitti Akahoshi Forceps</b></p> |  |
|--------|---|--|



**Dodick Nucleus Cracker**

Curved shafts, serrated paddles for cracking nucleus through 3mm incision. Flat, 3-hole, cross-action handle. Overall length: 108mm.

|        |                                      |  |
|--------|--------------------------------------|--|
| AF3175 | <p><b>Dodick Nucleus Cracker</b></p> |  |
|--------|--------------------------------------|--|



**Ernest Nucleus Cracker**

Angled, cross-action shafts, serrated paddle-shaped jaws. For use through a sub 2mm incision. Flat handle. Overall length: 108mm.

|          |                                      |  |
|----------|--------------------------------------|--|
| AF3145TI | <p><b>Ernest Nucleus Cracker</b></p> |  |
|----------|--------------------------------------|--|









**PRE-CHOPPER FORCEPS**

| Item #   | Description                           | Image  |
|--|---------------------------------------|--|
| <b>Salz Nucleus Splitter</b>                                 |                                       |  |
| Titanium. Vaulted shafts. Flat handle. Overall length: 76mm. |                                       |  |
| AF3177TI   | <a href="#">Salz Nucleus Splitter</a> |  |









**RETINAL FORCEPS**

| Item #  | Description                          | Image   |
|---|--------------------------------------|---|
| <b>Scleral Plug Forceps</b>   |                                      |   |
| Curved shafts, cross-action handle. Designed for insertion and removal of plugs. Overall length: 104mm. |                                      |   |
| AF5300  | <a href="#">Scleral Plug Forceps</a> |  |



**SUTURING FORCEPS**

| Item #   | Description  | Image  |
|--|--|--|
| <b>Bonn Suturing Forceps</b>   |  |  |
| Straight shafts, 0.12mm 1 x 2 teeth set at 90 degrees, 5mm tying platforms. Narrow, flat handle. |  |  |
| AF5100   | <a href="#">Short Suturing Forceps</a><br>Short flat handle. Overall length: 74mm.         |  |
| AF5110   | <a href="#">Long Suturing Forceps</a><br>Long flat handle. Overall length: 95mm.           |  |
| AF5110TI   | <a href="#">Long Suturing Forceps</a><br>Titanium. Long flat handle. Overall length: 95mm. |  |

SUTURING FORCEPS

| Item #  | Description  | Image  |
|---|--|--|
| <b>Castroviejo Suturing Forceps</b>   |  |  |
| Castroviejo Suturing Forceps are available in both titanium and stainless steel options with the choice of either straight or angled shafts. Tips have 1 x 2 teeth and vary in tip size and tying platform size. Overall length: 108mm. |  |  |
| AF5200  | <b>Suturing Forceps, 0.3mm</b><br>Straight shafts, 0.3mm 1 x 2 teeth, 5.5mm tying platform. Wide serrated handle.                    |    |
| AF5200TI  | <b>Titanium Suturing Forceps, 0.3mm</b><br>Titanium. Straight shafts, 0.3mm 1 x 2 teeth, 5.5mm tying platform. Wide serrated handle. |    |
| AF5170  | <b>Suturing Forceps, 0.5mm</b><br>Straight shafts, 0.5mm 1 x 2 teeth, 5.5mm tying platform. Wide serrated handle.                    |   |
| AF5140  | <b>Suturing Forceps, 0.5mm</b><br>Angled shafts, 0.5mm 1 x 2 teeth, 6mm tying platform. Wide serrated handle.                        |  |
| AF5170TI  | <b>Titanium Suturing Forceps, 0.5mm</b><br>Titanium. Straight shafts, 0.5mm 1 x 2 teeth, 5.5mm tying platform. Wide serrated handle. |  |
| AF5160  | <b>Suturing Forceps, 0.9mm</b><br>Straight shafts, 0.9mm 1 x 2 teeth, 5.5mm tying platform. Wide serrated handle.                    |  |
| AF5150  | <b>Suturing Forceps, 0.12mm</b><br>Straight shafts, 0.12mm 1 x 2 teeth, 5mm tying platform. Wide serrated handle.                    |  |
| AF5180  | <b>Suturing Forceps, 0.12mm</b><br>Straight shafts, 0.12mm 1 x 2 teeth, 5.5mm tying platform. Wide serrated handle.                  |  |

SUTURING FORCEPS

| Item #   | Description   | Image   |
|----------|---|---|
| AF5180K  | <p><b>Suturing Forceps, 0.12mm</b></p> <p>Straight shafts, 0.12mm 1 x 2 teeth, 5.5mm tying platform. Wide, 3-hole handle.</p>                     |  <p>AF5180K C</p> |
| AF5180TI | <p><b>Titanium Suturing Forceps, 0.12mm</b></p> <p>Titanium. Straight shafts, 0.12mm 1 x 2 teeth, 5.5mm tying platform. Wide serrated handle.</p> |                   |
| AF5190   | <p><b>Suturing Forceps, 1.5mm</b></p> <p>Straight shafts, 1.5mm 1 x 2 teeth, 5.5mm tying platform. Wide serrated handle.</p>                      |  <p>AF5190A</p>   |

**Fine-Castroviejo Suturing Forceps**

Straight shafts, 0.22mm 1 x 2 teeth, 6mm tying platform, narrow flat handle. Overall length: 111mm.

|        |   |  |
|--------|---|--|
| AF5210 | <p><b>Fine-Castroviejo Suturing Forceps</b></p> |  |
|--------|---|--|

**Kelman-McPherson Suturing Forceps**

45-degree angled shafts, 1 x 2 teeth. Flat handle. Overall length: 86mm.

|        |   |  |
|--------|---|--|
| AF5225 | <p><b>5mm Kelman-McPherson Forceps</b></p> <p>5mm tying platform.</p> |  <p>AF5225</p> |
| AF5220 | <p><b>8mm Kelman-McPherson Forceps</b></p> <p>8mm tying platform.</p> |  <p>AF5220</p> |

**SUTURING FORCEPS**

| Item # | Description | Image |
|--------|-------------|-------|
|--------|-------------|-------|

**Manhattan Eye and Ear Suturing Forceps**

Straight shafts, 1 x 2 teeth with 6mm tying platform. Flat handle. Overall length: 86mm.

|        |   |  |
|--------|---|--|
| AF5240 | <b>Manhattan Eye and Ear Suturing Forceps</b> |  |
|        |   |  |



**O’Gawa Suture Fixation Forceps**

O’Gawa Suture Fixation Forceps have straight shafts, round handles, and are available in stainless steel. Tips are available in various sizes and have 1 x 2 teeth with a 5.5mm tying platform.

|        |   |  |
|--------|---|--|
| AF2520 | <b>0.13mm Fixation Forceps</b>            |  |
|        | 0.13mm 1 x 2 teeth. Overall length: 86mm. |  |



|        |   |   |
|--------|---|---|
| AF2510 | <b>0.3mm Fixation Forceps</b>             |  |
|        | 0.3mm 1 x 2 teeth. Overall length: 111mm. |   |



**Paufique Suturing Forceps**

Straight shafts, 1 x 2 teeth, 6mm tying platform, wide serrated handle. Overall length: 86mm.

|        |                                  |  |
|--------|----------------------------------|--|
| AF5270 | <b>Paufique Suturing Forceps</b> |  |
|        |                                  |  |



**Stern-Castroviejo Suturing Forceps**

Straight shafts, 0.5mm 1 x 2 teeth, 6mm tying platform, wide flat handle with lock. Overall length: 111mm.

|        |   |  |
|--------|---|--|
| AF5290 | <b>Stern-Castroviejo Suturing Forceps</b> |  |
|        |   |  |



TISSUE FORCEPS

| Item # | Description | Image |
|--------|-------------|-------|
|--------|-------------|-------|

**Adson Tissue Forceps**

Straight shafts, delicate teeth. Flat handle.

AF6135 **0.5mm Adson Tissue Forceps**  
Extra delicate, 1 x 2, 0.5mm teeth. Overall length: 120mm.



AF6137 **0.5mm Adson Tissue Forceps**  
Delicate, 2 x 3, 0.5mm teeth. Overall length: 125mm.



AF6136 **1.5mm Adson Tissue Forceps**  
Delicate, 1 x 2, 1.5mm teeth. Overall length: 120mm.



**Bishop-Harmon Tissue Forceps**

Straight shafts with teeth or serrated tips. Flat, 3-hole handle. Overall length: 89mm.

AF6100 **0.3mm Bishop-Harman Forceps**  
0.3mm 1 x 2 teeth.

AF6101 **0.5mm Bishop-Harman Forceps**  
0.5mm 1 x 2 teeth.

AF2105 **0.8mm Bishop-Harman Forceps**  
0.8mm cross serrated tips.

AF6110 **0.8mm Bishop-Harman Forceps**  
0.8mm 1 x 2 teeth.



**Hoskins Tissue Forceps**

Straight shafts, micro-groove tips. Flat, fenestrated handle. Overall length: 83mm.

AFI400 **Hoskins Forceps #19**  
Micro-groove tips.

AFI403 **Hoskins Forceps #28**  
Delicate micro-groove tips.



TISSUE FORCEPS

| Item #   | Description   | Image  |
|--|---|--|
| <b>Tissue Forceps</b>  |   |  |
| Straight shafts, 1 x 2 teeth. Flat handle. Overall length: 98mm. |   |  |
| AF6130   | <b>Delicate Tissue Forceps</b><br>Delicate 1 x 2 teeth. |  |
| AF6140   | <b>Heavy Tissue Forceps</b><br>Heavy 1 x 2 teeth.       |  |

TYING FORCEPS

| Item #  | Description  | Image   |
|---|--|---|
| <b>Bechert-McPherson Angled Tying Forceps</b>                                     |  |   |
| Angled shafts, 10mm tying platform. Narrow serrated handle. Overall length: 86mm. |  |   |
| AF6300  | <b>Stainless Steel Tying Forceps</b><br>Stainless steel. |  |
| AF6300TI  | <b>Titanium Tying Forceps</b><br>Titanium.               |   |

**Castroviejo Tying Forceps**

|  |                                  |  |
|--|----------------------------------|--|
| Straight shafts, 5mm tying platform. Flat, wide handle. Overall length: 109mm. |                                  |  |
| AF6455   | <b>Castroviejo Tying Forceps</b> |  |

**Fine Tying Forceps**

|  |                                  |  |
|--|----------------------------------|--|
| Curved shafts and tips, smooth, delicate jaws, tying platform tips. Wide serrated handle. Overall length: 108mm. |                                  |  |
| AF6330   | <b>Curved Fine Tying Forceps</b> |  |

**TYING FORCEPS**

| Item # | Description | Image |
|--------|-------------|-------|
|--------|-------------|-------|

**Gerl Tying Forceps**

Curved shafts with smooth jaws and 6mm tying platform. Flat handle. Overall length: 86mm.

AF6580 [Gerl Tying Forceps](#)



**Girard Fine Tying Forceps**

Straight shafts, ultra-fine 0.5mm tying platform. Round handle. Overall length: 100mm.

AF6351 [Girard Fine Tying Forceps](#)



**Harms-Tuebingen Tying Forceps**

Straight and curved shafts, smooth jaws. Narrow, flat handle. Overall length: 101mm.

AF6370 [Harms-Tuebingen Tying Forceps, Straight](#)  
Straight shafts, 6mm tying platform.



AF6360 [Harms-Tuebingen Tying Forceps, Curved](#)  
Curved shafts, 7mm tying platform.



**Jaffe Tying Forceps**







Very delicate, curved, smooth jaws, 6.0mm tying platform. Flat, 3-hole handle. Overall length: 101mm.

AF6380 [Jaffe Tying Forceps](#)





TYING FORCEPS

| Item #  | Description   | Image  |
|---|---|--|
| <b>Kelman-McPherson Tying Forceps</b>             |   |  |
| Angled shafts. Flat handle. Overall length: 86mm. |   |  |
| AF6400 S  | <p><b>5mm Tying Forceps</b><br/>5mm bend from tip, 5mm tying platform. Flat handle.</p>   |    |
| AF6400  | <p><b>7.5mm Tying Forceps</b><br/>8mm bend from tip, 7.5mm tying platform. Flat, 3-hole handle.</p>   |    |
| AF6404  | <p><b>7.5mm Tying Forceps</b><br/>8mm bend from tip, 7.5mm tying platform. Narrow, flat handle.</p>   |    |
| AF6400TI  | <p><b>7.5mm Tying Forceps</b><br/>Titanium. 8mm bend from tip, 7.5mm tying platform. Narrow, flat handle.</p>   |  |
| <b>McPherson Tying Forceps</b>                    |   |  |
| Straight and angled shafts. Flat handle.          |   |  |
| AF6410  | <p><b>McPherson Tying Forceps, Angled</b><br/>Angled shafts, 5mm bend from tip, 5mm tying platform. Flat, 3-hole handle. Overall length: 98mm.</p>            |  |
| AF6410S   | <p><b>McPherson Tying Forceps, Angled</b><br/>Angled shafts, 5mm bend from tip, 5mm tying platform. Flat serrated handle. Overall length: 98mm.</p>           |  |
| AF6410TI  | <p><b>McPherson Tying Forceps, Angled</b><br/>Titanium. Angled shafts, 5mm bend from tip, 5mm tying platform. Flat serrated handle. Overall length: 98mm.</p> |  |



TYING FORCEPS

| Item #   | Description   | Image  |
|----------|---|--|
| AF6420   | <b>McPherson Tying Forceps, Straight</b><br>Straight shafts, 5mm tying platform. Flat, 3-hole handle. Overall length: 101mm.          | A pair of straight tying forceps with a flat handle featuring three circular holes. The shafts are straight and converge to a fine point. An inset image shows the tips of the forceps. The handle is engraved with 'AF6420 C'.              |
| AF6420TI | <b>McPherson Tying Forceps, Straight</b><br>Titanium. 4mm tying platform. Flat handle. Overall length: 86mm.                          | A pair of straight tying forceps with a flat handle. The shafts are straight and converge to a fine point. An inset image shows the tips of the forceps. The handle is engraved with 'AF6420 TI'.  |
| AF6424   | <b>McPherson Tying Forceps, Straight</b><br>Straight shafts, 5mm tying platform. Flat serrated handle. Overall length: 101mm.         | A pair of straight tying forceps with a flat handle featuring a serrated texture. The shafts are straight and converge to a fine point. An inset image shows the tips of the forceps. The handle is engraved with 'AF6424 C'.                |
| AF6421   | <b>McPherson Tying Forceps, Straight</b><br>Straight shafts, 5mm tying platform. Flat, narrow, serrated handle. Overall length: 86mm. | A pair of straight tying forceps with a flat, narrow handle featuring a serrated texture. The shafts are straight and converge to a fine point. An inset image shows the tips of the forceps. The handle is engraved with 'ACCUTOME AF6421'. |

**O’Gawa Tying Forceps**

Curved shafts, 5.5mm tying platform, 0.3mm gap at platform heel. Round, knurled handle. Overall length: 108mm.







|        |                             |  |
|--------|-----------------------------|--|
| AF6430 | <b>Curved Tying Forceps</b> | A pair of curved tying forceps with a round, knurled handle. The shafts are curved and converge to a fine point. The handle is engraved with 'AF6430'. |
|--------|-----------------------------|--|

**O’Gawa-Castroviejo Tying Forceps**

Straight shafts, 6mm tying platform tips. Wide serrated handle. Overall length: 111mm.

|        |                               |  |
|--------|-------------------------------|--|
| AF6450 | <b>Straight Tying Forceps</b> | A pair of straight tying forceps with a wide, serrated handle. The shafts are straight and converge to a fine point. The handle is engraved with 'AF6450'. |
|--------|-------------------------------|--|

TYING FORCEPS

| Item #   | Description  | Image  |
|--|--|--|
| <b>Sheets-McPherson Tying Forceps</b>  |  |  |
| 45-degree angled shafts, 10.5mm tying platform. Serrated criss-cross tips. Flat handle. Overall length: 86mm.                                      |  |  |
| AF6470   | <a href="#">Sheets-McPherson Tying Forceps</a>   |    |
| <b>Tennant Tying Forceps</b>   |  |  |
| Tennant Tying Forceps with both straight and curved shafts. Delicate and extra delicate tips with 6mm tying platform. Round handle with guide pin. |  |  |
| AF6350   | <a href="#">Tennant Tying Forceps, Straight</a><br>Straight shafts, extra delicate. Overall length: 101mm.           |    |
| AF6350TI   | <a href="#">Tennant Tying Forceps, Straight</a><br>Titanium. Straight shafts, extra delicate. Overall length: 101mm. |   |
| AF6355   | <a href="#">Tennant Tying Forceps, Curved</a><br>Curved shafts, delicate. Overall length: 98mm.                      |  |
| AF6355T  | <a href="#">Tennant Tying Forceps, Curved</a><br>Titanium. Curved shafts, delicate. Overall length: 110mm.           |  |
| AF6530   | <a href="#">Tennant Tying Forceps, Curved</a><br>Curved shafts, extra delicate. Overall length: 98mm.                |  |

UTILITY FORCEPS

| Item # | Description | Image |
|--------|-------------|-------|
|--------|-------------|-------|

**Alabama University Utility Forceps**

Straight shafts, fitted V-groove jaws. Flat handle. Overall length: 92mm.

|        |  |
|--------|--|
| AF6700 | <a href="#">Alabama University Utility Forceps</a> |
|--------|--|



**Bonaccolto Utility Forceps**

Straight shafts, with serrated tips. Flat, narrow handle. Overall length: 111mm.

|        |   |
|--------|---|
| AF6720 | <a href="#">1.2 Utility Forceps</a><br>1.2 x 16mm jaws. |
|--------|---|

|        |   |
|--------|---|
| AF6710 | <a href="#">1.7 Utility Forceps</a><br>1.7 x 17mm jaws. |
|--------|---|

|        |   |
|--------|---|
| AF6730 | <a href="#">2.4 Utility Forceps</a><br>2.4 x 16mm jaws. |
|--------|---|



**Gill Iris Forceps**

Curved shafts, delicate, cross-serrated jaws, flat handle. Overall length: 70mm.

|        |                                   |
|--------|-----------------------------------|
| AF3540 | <a href="#">Gill Iris Forceps</a> |
|--------|-----------------------------------|



**Kennerdell Bayonet Forceps**

Bayonet shafts with 17mm serrated tips, 83mm bend from tip. No teeth. Overall length: 160mm.

|        |  |
|--------|--|
| AF6930 | <a href="#">Kennerdell Bayonet Forceps</a> |
|--------|--|



**Nugent Utility Forceps**

Nugent stainless steel utility forceps have angled shafts with 45-degree angled jaws. Jaws are available in both serrated and smooth and are 10mm long. Flat, narrow handle. Overall length: 108mm.

|        |  |
|--------|--|
| AF6760 | <a href="#">Serrated Utility Forceps</a><br>Serrated tips. |
|--------|--|



UTILITY FORCEPS





| Item # | Description                                   | Image  |
|--------|---|--|
| AF6770 | <b>Smooth Utility Forceps</b><br>Smooth tips. |  |

**Wills Hospital Utility Forceps**

Straight shafts with 13mm long criss-cross serrated tips, narrow handle. Overall length: 111mm.









|        |                                       |  |
|--------|---------------------------------------|--|
| AF6780 | <b>Wills Hospital Utility Forceps</b> |  |
|--------|---------------------------------------|--|

CLAMPS





| Item #   | Description  | Image  |
|--|--|--|
| <b>Clamp</b>   |  |  |
| Various brands of towel clamps with different types of tips and handles. |  |  |
| AF6900   | <b>Baby Jones Towel Clamp</b><br>Curved shafts, sharp pointed tips. 2 1/2" cross-action flat handle. Overall length: 55mm. |  |
| AF6910   | <b>Long Towel Clamp Forceps</b><br>Curved shafts, sharp pointed tips. Ring handle. Overall length: 133mm.                  |  |
| AM0560   | <b>Serrefine Clamp</b><br>Straight shafts, stainless steel, 10mm serrated jaws. Flat handle. Overall length: 36mm.         |  |
| AF6920   | <b>Short Towel Clamp Forceps</b><br>Curved shafts, sharp pointed tips. Ring handle. Overall length: 89mm.                  |  |

# I/A & Bimanual Handpieces



## DISPOSABLE I/A INSTRUMENTS

| Item #   | Description  | Image  |
|--|--|--|
| <b>Bimanual I/A System</b>   |  |  |
| Single-use bimanual I/A systems are a solution for preventing infection. These products are guaranteed to be sterile and safe from contaminants. Comes two handpieces per pack, one irrigating, one aspirating. Aspiration-handpiece 0.8 mm [21g] with curved cannula, aspiration port 0.35 mm, textured tip for capsule polishing AEROPLANE nose shape. Irrigation-handpiece 0.8 mm [21G] with curved cannula. Sold 10 per box. |  |  |
| AB-9105B   | <b>Single Port I/A System</b><br>Open ended irrigation port 0.50 mm for active rinsing.                                |    |
| AB-9110B   | <b>Dual Port I/A System</b><br>Two irrigation ports 0.45 mm.   |   |
| <b>Mono-Manual I/A System</b>  |  |  |
| This range of coaxial I/A systems features straight and angled versions at 30 degrees, 45 degrees, and 65 degrees. All models are available as 19g, 20g, 21g, and 23g versions for incisions of 2.8mm to 1.8 mm. The textured aspiration tips can be used for selective polishing of the posterior capsule. Sold 10 per box.   |  |  |
| AB-9170P   | <b>I/A Handpiece, 1.8mm</b><br>Aspiration cannula angled 45 degrees, for incisions of 1.8mm, polished aspiration head. |    |
| AB-9175P   | <b>I/A Handpiece, 1.8mm</b><br>Aspiration cannula curved, for incisions of 1.8mm, polished aspiration head.            |  |
| AB-9155P   | <b>I/A Handpiece, 2.2mm</b><br>Aspiration cannula angled 45 degrees, for incisions of 2.2mm, polished aspiration head. |  |
| AB-9160P   | <b>I/A Handpiece, 2.2mm</b><br>Aspiration cannula curved, for incisions of 2.2mm, polished aspiration head.            |  |
| AB-9115  | <b>I/A Handpiece, 2.5mm</b><br>Aspiration cannula straight, for incisions of 2.5mm, textured aspiration head.          |  |
| AB-9125P   | <b>I/A Handpiece, 2.5mm</b><br>Aspiration cannula angled 45 degrees, for incisions of 2.5mm, polished aspiration head. |  |

DISPOSABLE I/A INSTRUMENTS

| Item #  | Description  | Image   |
|---------|--|---|
| AB-9135 | <b>I/A Handpiece, 2.5mm</b><br>Aspiration cannula angled 65 degrees, for incisions of 2.5mm, textured aspiration head. |   |
| AB-9110 | <b>I/A Handpiece, 2.8mm</b><br>Aspiration cannula straight, for incisions of 2.8mm, textured aspiration head.          |   |
| AB-9120 | <b>I/A Handpiece, 2.8mm</b><br>Aspiration cannula angled 45 degrees, for incisions of 2.8mm, textured aspiration head. |   |
| AB-9130 | <b>I/A Handpiece, 2.8mm</b><br>Aspiration cannula angled 65 degrees, for incisions of 2.8mm, textured aspiration head. |  |

REUSABLE I/A INSTRUMENTS

| Item #  | Description   | Image  |
|---|---|--|
| <b>Bimanual Aspirating Unit</b>   |   |  |
| Reusable Bimanual Aspirating Units come in 21 gauge or 23 gauge cannula tips size options. Each cannula tip has a curved shaft with a single 0.3mm port and closed round tip. Aspirating handle is titanium. Overall length: 111mm. |   |  |
| AC7032  | <b>Bimanual Aspirating Unit, 21g</b><br>21 gauge, smooth cannula tip.               |  |
| AC7030  | <b>Bimanual Aspirating Unit, 21g</b><br>21 gauge, sandblasted capsule polisher tip. |  |
| AC7100  | <b>Bimanual Aspirating Unit, 23g</b><br>23 gauge, smooth cannula tip.               |  |



## REUSABLE I/A INSTRUMENTS

| Item # | Description   | Image  |
|--------|---|--|
| AC7110 | <b>Bimanual Aspirating Unit, 23g</b><br>23 gauge, sandblasted capsule polisher tip. |  A long, thin, gold-colored instrument with a curved tip. An inset image shows a close-up of the sandblasted capsule polisher tip. |





**Bimanual Aspiration Cannula Tip**

Reusable Bimanual Aspiration Cannula Tips come in 21 gauge or 23 gauge with a curved shaft. This is only the tip not the whole unit. Each tip has a sandblasted capsule polisher tip with a single 0.3mm sideport. Overall length: 21mm.

|        |  |  |
|--------|--|--|
| AC7430 | <b>Bimanual Aspiration Tip, 21g</b><br>21 gauge. |  A curved, silver-colored cannula tip with a sideport. An inset image shows a close-up of the tip. The main image shows the tip attached to a grey handle with a red knob. |
| AC7431 | <b>Bimanual Aspiration Tip, 23g</b><br>23 gauge. |  |

**Bimanual Irrigating Unit**

Reusable Bimanual Irrigating Units come in 21 gauge or 23 gauge cannula tips size options. Each cannula tip has a straight or curved shaft and various tip types. Irrigating handle is titanium. Overall length: 111mm.

|        |  |  |
|--------|--|--|
| AC7000 | <b>Bimanual Irrigating Unit, 21g</b><br>21 gauge cannula tip, straight shaft, open ended.                                    |  A blue-handled irrigating unit with a straight shaft and an open-ended tip. An inset image shows a close-up of the open tip. |
| AC7010 | <b>Bimanual Irrigating Unit, 21g</b><br>21 gauge cannula tip, curved shaft, open ended.                                      |  A blue-handled irrigating unit with a curved shaft and an open-ended tip. An inset image shows a close-up of the open tip.  |
| AC7040 | <b>Bimanual Irrigating Unit, 21g</b><br>21 gauge cannula tip, straight shaft, 0.5mm dual ports, closed rounded tip.          |  A blue-handled irrigating unit with a straight shaft and a closed rounded tip. An inset image shows a close-up of the tip.  |
| AC7050 | <b>Bimanual Irrigating Unit, 21g</b><br>21 gauge cannula tip, curved shaft, 0.5mm dual ports, closed rounded tip.            |  A blue-handled irrigating unit with a curved shaft and a closed rounded tip. An inset image shows a close-up of the tip.    |
| AC7130 | <b>Bimanual Irrigating Unit, 23g</b><br>23 gauge cannula tip, thin wall, curved shaft, 0.4mm dual ports, closed rounded tip. |  A blue-handled irrigating unit with a curved shaft and a closed rounded tip. An inset image shows a close-up of the tip.    |



## REUSABLE I/A INSTRUMENTS

| Item # | Description  | Image  |
|--------|--|--|
| AC7120 | <b>Bimanual Irrigating Unit, 23g</b><br>23 gauge cannula tip, thin wall, straight shaft, 0.4mm dual ports, closed rounded tip. |  |

**Bimanual Irrigation Cannula Tip**

Reusable Bimanual Irrigation Cannula Tips come in 21 gauge or 23 gauge with a curved shaft. This is only the tip not the whole unit. Various tip types are available. Overall length: 21mm.

|        |  |  |
|--------|--|--|
| AC7450 | <b>Bimanual Irrigation Tip, 21g</b><br>21 gauge, 0.5mm dual ports, closed rounded tip.                 |    |
| AC7451 | <b>Bimanual Irrigation Tip, 23g</b><br>23 gauge, thin wall, 0.4mm dual ports, closed rounded tip.      |   |
| AC7530 | <b>Bimanual Irrigation Tip, 23g</b><br>23 gauge, thin wall, 0.4mm dual oval ports, closed rounded tip. |  |

**Donnenfeld Irrigating Hook**

Designed in conjunction with Eric D. Donnenfeld, M.D., specifically for the placement of Toric IOLs. The stainless steel Donnenfeld Irrigating Hook is 23 gauge and has two irrigating ports that are positioned at the tip of the instrument, which open the capsular bag allowing the surgeon to rotate the Toric IOL. The hook on the bottom of the instrument gently grabs the haptic for rotation.

|        |                                   |  |
|--------|-----------------------------------|--|
| AC8000 | <b>Donnenfeld Irrigating Hook</b> |  |
|--------|-----------------------------------|--|

**I/A Handpiece**









Please note that titanium handles are only interchangeable with titanium tips and stainless handles are only interchangeable with stainless tips. Replacement O-ring sets are also available for both stainless and titanium products. Please note that silicone sleeves are not included with tips.

|        |   |  |
|--------|---|--|
| AC5120 | <b>Stainless Steel I/A Handpiece</b><br>Male aspiration connector in stainless steel. |  |
|--------|---|--|

## REUSABLE I/A INSTRUMENTS

| Item #   | Description   | Image  |
|--|---|--|
| AC5120T  | <b>Titanium I/A Handpiece</b><br>Male aspiration connector in titanium.   | A long, slender, blue-tinted titanium handpiece with a textured grip section and a male aspiration connector at the tip. The text 'ACCU TOME USA LTD' and 'AC5120T C' is visible on the handle.  |
| <b>I/A Tip</b>   |   |  |
| Please note that titanium handles are only interchangeable with titanium tips and stainless handles are only interchangeable with stainless tips. Replacement O-ring sets are also available for both stainless and titanium products. Please note that silicone sleeves are not included with tips. |   |  |
| AC5215   | <b>Coaxial I/A Tip, Straight</b><br>Coaxial I/A tip with straight shaft and tip. 0.5mm dual sideport aspiration and 16g irrigation sleeve.  | A stainless steel coaxial I/A tip with a straight shaft and a conical tip. It features dual sideport aspiration and a 16g irrigation sleeve. The text 'AC5215 C' is visible on the tip.  |
| AC5141T  | <b>Coaxial I/A Tip, Straight</b><br>Titanium, coaxial I/A tip with straight shaft and tip. 0.5mm dual sideport aspiration and 16g irrigation sleeve.  | A titanium coaxial I/A tip with a straight shaft and a conical tip. It features dual sideport aspiration and a 16g irrigation sleeve. The text 'AC5141 T' is visible on the tip.   |
| AC5235T  | <b>Coaxial I/A Tip, Straight</b><br>Titanium, 21g, coaxial I/A tip with straight shaft and tip. 0.3mm dual sideport aspiration. Made for use with silicone irrigation sleeve (sold separately). | A titanium coaxial I/A tip with a straight shaft and a conical tip. It features dual sideport aspiration and a 16g irrigation sleeve. A light blue silicone sleeve is attached to the tip. The text 'AC5235 T' is visible on the tip.        |
| AC5235   | <b>Coaxial I/A Tip, Straight</b><br>21g, coaxial I/A tip with straight shaft and tip. 0.3mm dual sideport aspiration. Made for use with silicone irrigation sleeve (sold separately).           | A stainless steel coaxial I/A tip with a straight shaft and a conical tip. It features dual sideport aspiration and a 16g irrigation sleeve. A light blue silicone sleeve is attached to the tip. The text 'AC5235 C' is visible on the tip. |
| AC5140   | <b>Coaxial I/A Tip, Curved</b><br>Coaxial I/A tip with straight shaft and tip. 0.3mm dual sideport aspiration and 16g irrigation sleeve.  | A stainless steel coaxial I/A tip with a straight shaft and a curved tip. It features dual sideport aspiration and a 16g irrigation sleeve. The text 'AC5140 C' is visible on the tip.   |
| AC5140T  | <b>Coaxial I/A Tip, Curved</b><br>Titanium, coaxial I/A tip with straight shaft and tip. 0.3mm dual sideport aspiration and 16g irrigation sleeve.  | A titanium coaxial I/A tip with a straight shaft and a curved tip. It features dual sideport aspiration and a 16g irrigation sleeve. The text 'AC5140 T' is visible on the tip.  |
| AC5150   | <b>Coaxial I/A Tip, Curved</b><br>Coaxial I/A tip with curved shaft and straight tip. 0.3mm dual sideport aspiration and 16g irrigation sleeve.   | A stainless steel coaxial I/A tip with a curved shaft and a straight tip. It features dual sideport aspiration and a 16g irrigation sleeve. The text 'AC5150 C' is visible on the tip.   |

## REUSABLE I/A INSTRUMENTS

| Item #  | Description  | Image  |
|---------|--|--|
| AC5150T | <b>Coaxial I/A Tip, Curved</b><br>Titanium, coaxial I/A tip with curved shaft and straight tip. 0.3mm dual sideport aspiration and 16g irrigation sleeve.  |    |
| AC5151  | <b>Coaxial I/A Tip, Curved</b><br>Coaxial I/A tip with curved shaft and straight tip. 0.5mm dual sideport aspiration and 16g irrigation sleeve.  |    |
| AC5151T | <b>Coaxial I/A Tip, Curved</b><br>Titanium, coaxial I/A tip with curved shaft and straight tip. 0.5mm dual sideport aspiration and 16g irrigation sleeve.  |    |
| AC5245  | <b>Coaxial I/A Tip, Curved</b><br>2lg coaxial I/A tip with curved shaft and tip. 0.3mm dual sideport aspiration. Made for use with silicone irrigation sleeve (sold separately).                         |   |
| AC5245T | <b>Coaxial I/A Tip, Curved</b><br>Titanium, 2lg, coaxial I/A tip with curved shaft and tip. 0.3mm dual sideport aspiration. Made for use with silicone irrigation sleeve (sold separately).              |  |
| AC5160  | <b>Coaxial I/A Tip, 45 degrees</b><br>Coaxial I/A tip with straight shaft and 45-degree angled tip. 0.3mm dual sideport aspiration and 16g irrigation sleeve.  |  |
| AC5160T | <b>Coaxial I/A Tip, 45 degrees</b><br>Titanium, coaxial I/A tip with straight shaft and 45-degree angled tip. 0.3mm dual sideport aspiration and 16g irrigation sleeve.                                  |  |
| AC5220  | <b>Coaxial I/A Tip, 45 degrees</b><br>2lg, coaxial I/A tip with straight shaft and 45-degree angled tip. 0.3mm dual sideport aspiration. Made for use with silicone irrigation sleeve (sold separately). |  |



## REUSABLE I/A INSTRUMENTS

| Item #  | Description   | Image  |
|---------|---|--|
| AC5220T | <p><b>Coaxial I/A Tip, 45 degrees</b></p> <p>Titanium, 2lg, coaxial I/A tip with straight shaft and 45-degree angled tip. 0.3mm dual sideport aspiration. Made for use with silicone irrigation sleeve (sold separately).</p> |    |
| AC5170  | <p><b>Coaxial I/A Tip, 90 degrees</b></p> <p>Coaxial I/A tip with straight shaft and 90-degree curved tip. 0.3mm dual sideport aspiration and 16g irrigation sleeve.</p>  |    |
| AC5170T | <p><b>Coaxial I/A Tip, 90 degrees</b></p> <p>Titanium, coaxial I/A tip with straight shaft and 90-degree curved tip. 0.3mm dual sideport aspiration and 16g irrigation sleeve.</p>  |    |
| AC5180  | <p><b>Coaxial I/A Tip, 150 degrees</b></p> <p>Coaxial I/A tip with straight shaft and 150-degree curved tip. 0.3mm dual sideport aspiration and 16g irrigation sleeve.</p>  |   |
| AC5180T | <p><b>Coaxial I/A Tip, 150 degrees</b></p> <p>Titanium, coaxial I/A tip with straight shaft and 150-degree curved tip. 0.3mm dual sideport aspiration and 16g irrigation sleeve.</p>  |  |

# Knife Handles

A decorative horizontal bar with a blue gradient, transitioning from a darker blue on the left to a lighter blue on the right, positioned below the title.

**BARD-PARKER KNIFE HANDLES**

| Item #   | Description   | Image  |
|--|---|--|
| <b>Bard-Parker Knife Handle</b>  |   |  |
| Knife handle compatible with 10, 11, 12, and 15 style blades. Flat handle. |   |  |
| AH2505   | <b>Bard-Parker Knife, #3 Handle</b><br>Ruler markings. Overall length: 124mm. |  |
| AH2506   | <b>Bard-Parker Knife, #7 Handle</b><br>Overall length: 165mm.                 |  |
| AH2510   | <b>Bard-Parker Knife, #9 Handle</b><br>Overall length: 116mm.                 |  |



**BEAVER CHUCK KNIFE HANDLES**

| Item #   | Description                          | Image  |
|--|--------------------------------------|--|
| <b>Beaver Chuck Knife Handle</b>   |                                      |  |
| Collet tip, compatible with 50, 60, and 70 series blades. Round handle. Overall length: 102mm. |                                      |  |
| AH2515   | <b>Beaver Chuck Knife, #3 Handle</b> |  |

# Reusable Knives









## REUSABLE KNIVES

| Item #   | Description   | Image  |
|--|---|--|
| <b>Gill Corneal Knife</b>  |   |  |
| Straight shaft, 3mm x 18mm smooth blade. Flat handle. Overall length: 119mm.                                   |   |  |
| AH2540   | <a href="#">Gill Corneal Knife</a>                  |    |
| <b>Martinez Double-Ended Corneal Dissector Knife</b>   |   |  |
| Double-ended, angled shafts, 11mm from bend to tip, 3mm wide sharp blades. Flat handle. Overall length: 127mm. |   |  |
| AH2595   | <a href="#">Martinez Double-Ended Corneal Knife</a> |    |
| <b>Tooke Corneal Knife</b>   |   |  |
| Straight shaft, 3mm x 18mm smooth blade. Flat handle. Overall length: 119mm.                                   |   |  |
| AH2580   | <a href="#">Tooke Corneal Knife</a>                 |  |

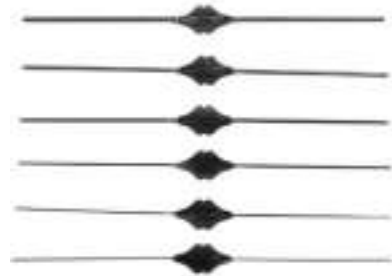

# Lacrimal Instruments

## LACRIMAL PROBES

| Item #  | Description  | Image  |
|---|--|--|
| <b>Bowman Lacrimal Probe Set</b>  |  |  |
| Set of six stainless steel probes. Double-ended. Overall length: 149mm. |  |  |
| AL1375  | <a href="#">Bowman Lacrimal Probe Set</a>  |    |
| <b>Bowman Lacrimal Probe</b>  |  |  |
| Variety of sizes. Sterling silver. Overall length: 149mm.               |  |  |
| AL1330  | <a href="#">Bowman Lacrimal Probe Sizes 0000 and 000</a><br>Sizes: 0000 and 000. |   |
| AL1320  | <a href="#">Bowman Lacrimal Probe Sizes 00 and 0</a><br>Sizes: 00 and 0.         |  |
| AL1340  | <a href="#">Bowman Lacrimal Probe Sizes 1 and 2</a><br>Sizes: 1 and 2.           |  |
| AL1350  | <a href="#">Bowman Lacrimal Probe Sizes 3 and 4</a><br>Sizes: 3 and 4.           |  |
| AL1360  | <a href="#">Bowman Lacrimal Probe Sizes 5 and 6</a><br>Sizes: 5 and 6.           |  |

## LACRIMAL PROBES

| Item # | Description  | Image  |
|--------|--|--|
| ALI370 | <a href="#">Bowman Lacrimal Probe Sizes 7 and 8</a><br>Sizes: 7 and 8. |  |

**Catalano Intubation Probe Set**

Set of two, 0.7mm diameter probes attached to 30.5cm long silicone tubing, 0.012" I.D., 0.025" O.D.

|        |   |  |
|--------|---|--|
| ALI530 | <a href="#">Catalano Intubation Set</a> |  |
|--------|---|--|

**Pigtail Probe**

Stainless steel, double-ended, straight shafts with pigtail curved probes on both ends, 8mm blunt probe tips with suture eye holes. Round handle. Overall length: 143mm.

|        |                               |   |
|--------|-------------------------------|---|
| ALI420 | <a href="#">Pigtail Probe</a> |  |
|--------|-------------------------------|---|

**Jackson Lacrimal Intubation Set**





2 blunt 0.9mm diameter probes, attached to 30.5cm long silicone tubing, 0.012" I.D., 0.025" O.D.

|        |   |  |
|--------|---|--|
| ALI400 | <a href="#">Jackson Lacrimal Intubation Set</a> |  |
|--------|---|--|

## LACRIMAL DILATORS



| Item #   | Description                                  | Image  |
|--|--|--|
| <b>Castroviejo Double-Ended Lacrimal Dilator</b>   |  |  |
| One needle-point end and one medium-taper end, round, knurled handle. Overall length: 140mm. |  |  |
| ALI380   | <a href="#">Castroviejo Lacrimal Dilator</a> |  |

## LACRIMAL DILATORS

| Item #   | Description   | Image  |
|--|---|--|
| <b>Hosford Double-Ended Lacrimal Dilator</b>   |   |  |
| 2.0mm tapered end, gradually tapered other end, rounded handle. Overall length 140mm.  |   |  |
| ALI390   | <a href="#">Hosford Double-Ended Lacrimal Dilator</a>                 |    |
| <b>Infant Lacrimal Dilator</b>   |   |  |
| Very fine, blunt tip. Round handle. Overall length: 79mm.  |   |  |
| ALI280   | <a href="#">Infant Lacrimal Dilator</a>                               |    |
| <b>Muldoon Lacrimal Dilator</b>  |   |  |
| Medium 27mm taper, distal end is straight to act as a guide for the tapered dilator that follows. Round, knurled handle. Overall length: 98mm. |   |  |
| ALI410   | <a href="#">Muldoon Lacrimal Dilator</a>                              |  |
| <b>Ruedemann Lacrimal Dilator</b>  |   |  |
| Short 12mm taper, needle type. Round handle. Overall length: 73mm.   |   |  |
| ALI430   | <a href="#">Ruedemann Lacrimal Dilator</a>                            |  |
| <b>Wilder Lacrimal Dilator</b>   |   |  |
| Long, medium, and short taper, blunt tip, round handle. Overall length: 98mm.  |   |  |
| ALI440   | <a href="#">Wilder Lacrimal Dilator, Long</a><br>Long 32mm taper.     |  |
| ALI450   | <a href="#">Wilder Lacrimal Dilator, Medium</a><br>Medium 23mm taper. |  |
| ALI460   | <a href="#">Wilder Lacrimal Dilator, Short</a><br>Short 19mm taper.   |  |

# LASEK Instruments

## LASEK INSTRUMENTS







| Item #   | Description   | Image  |
|--|---|--|
| <b>Camellin LASEK Trephine</b>                     |   |  |
| Doubled-ended. Flat handle. Overall length: 114mm. |   |  |
| AR0580   | <b>8mm Camellin LASEK Trephine</b><br>8mm LASEK trephine with 8.5mm alcohol well. |    |
| AR0585   | <b>9mm Camellin LASEK Trephine</b><br>9mm LASEK trephine with 9.5mm alcohol well  |  |
| <b>LASEK Alcohol Well</b>                          |   |  |
| 7.5mm to 9.5mm diameter. Round handle.             |   |  |
| AR0603   | <b>7.5mm LASEK Alcohol Well</b><br>7.5mm diameter.                                |    |
| AR0600   | <b>8.5mm LASEK Alcohol Well</b><br>8.5mm diameter                                 |  |
| AR0602   | <b>9.0mm LASEK Alcohol Well</b><br>9.0mm diameter.                                |  |
| AR0605   | <b>9.5mm LASEK Alcohol Well</b><br>9.5mm diameter.                                |  |
| <b>LASEK Epithelial Trephine</b>                   |   |  |
| 8.0mm and 9.5mm diameter. Round handle.            |   |  |
| AR0610   | <b>8.0mm LASEK Epithelial Trephine</b><br>8.0mm diameter.                         |  |
| AR0616   | <b>9.5mm LASEK Epithelial Trephine</b><br>9.5mm diameter.                         |  |

# Lens Loops



The background features a dark blue gradient with a faint, light blue grid pattern. A bright blue lens flare or light streak curves across the top left corner. Below the title, there are two horizontal bars: a solid blue bar and a lighter blue gradient bar.

## LENS LOOPS

| Item #   | Description   | Image  |
|--|---|--|
| <b>Gills-Welsh Lens Loop</b>   |   |  |
| Slightly curved loop tip, ultra thin and smooth loop. Flat handle.   |   |  |
| AH3110   | <b>Gills-Welsh Lens Loop</b><br>Straight shaft, 6mm wide x 7mm long loop. Overall length: 135mm.  |    |
| <b>Double-Ended Gills-Welsh Lens Loop</b>  |   |  |
| Double-ended. One side has a straight shaft with 5mm wide x 7mm long loop. One side has a curved shaft with olive-shaped tip. Overall length: 121mm. |   |  |
| AH3200   | <b>Double-Ended Gills-Welsh Lens Loop</b><br>Double-ended. One side has a straight shaft with 5mm wide x 7mm long loop. One side has a curved shaft with olive-shaped tip. Overall length: 121mm. |    |
| <b>Kansas Lens Loop</b>  |   |  |
| Curved shaft, 3.0mm wide-looped tip, serrated. Flat handle. Overall length: 137mm.   |   |  |
| AH3130   | <b>Kansas Lens Loop</b>   |   |
| <b>Keener-Alt Lens Loop</b>  |   |  |
| Straight shaft, curved loop tip, serrated loop, 3mm wide loop. Flat handle. Overall length: 137mm.   |   |  |
| AH3150   | <b>Keener-Alt Lens Loop</b>   |    |
| <b>Kirby Intra-Capsular Lens Loop</b>  |   |  |
| Straight shaft, 5mm x 10mm, curved, smooth loop tip. Round handle. Overall length: 138mm.  |   |  |
| AH3170   | <b>Kirby Intra-Capsular Lens Loop</b>   |   |



## LENS LOOPS

| Item # | Description | Image |
|--------|-------------|-------|
|--------|-------------|-------|

**Lewis Lens Loop**

Straight shaft, curved tear-drop-shaped loop. Flat handle. Overall length: 134mm.

|        |  |   |
|--------|--|---|
| AH3180 | <b>Lewis Lens Loop, Large</b><br>Large 5mm x 7mm loop. |  |
| AH3190 | <b>Lewis Lens Loop, Small</b><br>Small 4mm x 6mm loop. |   |

**New Orleans Eye and Ear Lens Loop**

Straight shaft, curved loop tip, 5mm wide x 10mm long smooth oval loop. Flat handle. Overall length: 142mm.

|        |  |
|--------|--|
| AH3210 | <b>New Orleans Eye and Ear Lens Loop</b> |
|--------|--|

**Simcoe Double-Ended Nucleus Loop**

Double-ended, both ends angled loops, 4mm wide x 20mm long loops, serrations on tops of loops. Round handle. Overall length: 140mm.

|        |   |
|--------|---|
| AH3220 | <b>Simcoe Double-Ended Nucleus Loop</b> |
|--------|---|

**Wilder Lens Loop**





Straight shaft, curved tip, long tear-drop-shaped loop, serrated 4mm x 14mm loop. Flat handle. Overall length: 136mm.

|        |                         |
|--------|-------------------------|
| AH3230 | <b>Wilder Lens Loop</b> |
|--------|-------------------------|











# Needle Holders





## LOCKING NEEDLE HOLDERS

| Item #   | Description   | Image  |
|--|---|--|
| <b>Anis Needle Holder, Locking</b>   |   |  |
| Stainless steel Anis Needle Holders with locking mechanisms come with either a straight or curved extra delicate 8mm jaw pattern. Overall length: 127mm. |   |  |
| AN0120   | <b>Anis Needle Holder, Curved</b><br>Curved shaft.  |    |
| AN0140   | <b>Anis Needle Holder, Straight</b><br>Straight shaft.  |  |
| <b>Barraquer Needle Holder, Locking</b>  |   |  |
| Straight and curved jaws, with various jaw sizes and styles. Comes with a locking mechanism.   |   |  |
| AN0210   | <b>Barraquer Needle Holder, Straight</b><br>Straight, 9mm delicate jaws with lock. Overall length: 130mm.           |    |
| AN0210T1   | <b>Barraquer Needle Holder, Straight</b><br>Titanium. Straight, 9mm delicate jaws with lock. Overall length: 130mm. |  |
| AN0150   | <b>Barraquer Needle Holder, Curved</b><br>Curved, 9mm delicate jaws with lock. Overall length: 130mm.               |  |
| AN0510   | <b>Barraquer Needle Holder, Curved</b><br>Curved, 9mm medium jaws with lock. Overall length: 130mm.                 |  |
| AN0150T1   | <b>Barraquer Needle Holder, Curved</b><br>Titanium, curved, 9mm delicate jaws with lock. Overall length: 133mm.     |  |
| AN0160   | <b>Barraquer Needle Holder, Curved</b><br>Curved, 9mm standard jaws with lock. Overall length: 130mm.               |  |

## LOCKING NEEDLE HOLDERS

| Item #   | Description  | Image  |
|--|--|--|
| AN0160TI   | <b>Barraquer Needle Holder, Curved</b><br>Titanium, curved, 9mm medium jaws with lock. Overall length: 130mm.        |    |
| AN0170T  | <b>Barraquer Needle Holder, Curved</b><br>Titanium, curved, 10mm fine jaws with lock. Overall length: 136mm.         |    |
| <b>Castroviejo Needle Holder, Locking</b>  |  |  |
| Straight and curved jaws, with various jaw sizes and styles. Comes with a locking mechanism. |  |  |
| AN0310   | <b>Castroviejo Needle Holder, Straight</b><br>Straight, 9mm fine jaws with lock. Overall length: 139mm.              |    |
| AN0270   | <b>Castroviejo Needle Holder, Straight</b><br>Straight, 9mm medium jaws with lock. Overall length: 140mm.            |  |
| AN0300   | <b>Castroviejo Needle Holder, Straight</b><br>Straight, 10mm medium jaws with lock. Overall length: 136mm.           |  |
| AN0300TI   | <b>Castroviejo Needle Holder, Straight</b><br>Titanium. Straight, 10mm medium jaws with lock. Overall length: 136mm. |  |
| AN0290   | <b>Castroviejo Needle Holder, Straight</b><br>Straight, 12mm heavy jaws with lock. Overall length: 136mm.            |  |
| AN0280   | <b>Castroviejo Needle Holder, Straight</b><br>Straight, 16mm heavy jaws with lock. Overall length: 149mm.            |  |

## LOCKING NEEDLE HOLDERS

| Item #   | Description  | Image   |
|----------|--|---|
| AN0230   | <b>Castroviejo Needle Holder, Curved</b><br>Curved, 9mm fine jaws with lock. Overall length: 139mm.              |   |
| AN0240   | <b>Castroviejo Needle Holder, Curved</b><br>Curved, 11mm medium jaws with lock. Overall Length: 135mm.           |   |
| AN0240TI | <b>Castroviejo Needle Holder, Curved</b><br>Titanium, curved, 11mm medium jaws with lock. Overall length: 136mm. |   |
| AN0250   | <b>Castroviejo Needle Holder, Curved</b><br>Curved, 12mm standard jaws with lock. Overall length: 136mm.         |  |

**Jaffe Needle Holder**

Straight, delicate jaws with lock. Flat, 3-hole handle.







|        |                            |  |
|--------|----------------------------|--|
| AN0400 | <b>Jaffe Needle Holder</b> |  |
|--------|----------------------------|--|

**Kalt Needle Holder**







Kalt Needle Holders with straight jaws. Available in standard, medium, or heavy jaws with or without serration. Flat, cross-action handle. Overall length: 143mm.

|        |  |  |
|--------|--|--|
| AN0410 | <b>Heavy Needle Holder</b><br>Straight, heavy 12mm serrated jaws with lock.          |  |
| AN0430 | <b>Medium Needle Holder</b><br>Straight, medium 10mm finely serrated jaws with lock. |  |
| AN0440 | <b>Standard Needle Holder</b><br>Straight, standard 10mm jaws with lock.             |  |

## LOCKING NEEDLE HOLDERS

| Item #  | Description   | Image  |
|---|---|--|
| <b>McPherson Needle Holder</b>  |   |  |
| McPherson Needle Holders are available in both straight and curved, very delicate 11mm jaw options. Comes with locking mechanism. Flat, cross-action handle. Overall length: 107mm. |   |  |
| AN0460  | <b>Needle Holder, Curved</b><br>Strongly curved jaws.   |    |
| AN0480  | <b>Needle Holder, Straight</b><br>Straight jaws.  |    |
| <b>Needle Holder, Locking</b>   |   |  |
| Various stainless steel or titanium needle holders with curved or straight shafts. Different jaw sizes and styles are available. Comes with locking mechanism.                      |   |  |
| AN0500  | <b>Needle Holder, Curved</b><br>Curved, 6mm extra delicate jaws with lock. Overall length: 120mm.     |   |
| AN0620  | <b>Needle Holder, Curved</b><br>Titanium, curved, 9mm delicate jaws with lock. Overall length: 130mm. |  |
| AN0540  | <b>Needle Holder, Straight</b><br>Straight, 6mm extra delicate jaws with lock. Overall length: 120mm. |  |
| <b>Troutman Needle Holder</b>   |   |  |
| Gently curved, medium 9mm smooth jaws with lock. Round handle with longitudinal serrations. Overall length: 120mm.  |   |  |
| AN0600  | <b>Troutman Needle Holder</b>   |  |

## NON-LOCKING NEEDLE HOLDERS

| Item #  | Description  | Image   |
|---|--|---|
| <b>Anis Needle Holder, Non-Locking</b>  |  |   |
| Anis Needle Holders without locks come with either straight or curved 8mm delicate jaws. Various jaw styles are available. Overall length: 127mm. |  |   |
| AN0110  | <b>Anis Needle Holder, Curved</b><br>Curved jaws.  |  Anis Needle Holder, Curved. The image shows a close-up of the curved jaws and the full view of the instrument with a silver handle and a curved tip.                 |
| AN0110TI  | <b>Anis Needle Holder, Curved</b><br>Titanium. Curved jaws.                                  |  Anis Needle Holder, Curved (Titanium). The image shows a close-up of the curved jaws and the full view of the instrument with a blue handle and a curved tip.        |
| AN0130  | <b>Anis Needle Holder, Straight</b><br>Straight jaws.  |  Anis Needle Holder, Straight. The image shows a close-up of the straight jaws and the full view of the instrument with a silver handle and a straight tip.           |
| <b>Barraquer Needle Holder, Non-Locking</b>   |  |   |
| Straight and curved jaws, with various jaw sizes and styles. No locking mechanisms.   |  |   |
| AN0220  | <b>Barraquer Needle Holder, Straight</b><br>Straight, 9mm jaws. Overall length: 133mm.       |  Barraquer Needle Holder, Straight. The image shows a close-up of the straight jaws and the full view of the instrument with a silver handle and a straight tip.    |
| AN0180  | <b>Barraquer Needle Holder, Curved</b><br>Curved, 9mm jaws. Overall length: 130mm.           |  Barraquer Needle Holder, Curved. The image shows a close-up of the curved jaws and the full view of the instrument with a silver handle and a curved tip.          |
| AN0180TI  | <b>Barraquer Needle Holder, Curved</b><br>Titanium. Curved, 9mm jaws. Overall length: 130mm. |  Barraquer Needle Holder, Curved (Titanium). The image shows a close-up of the curved jaws and the full view of the instrument with a blue handle and a curved tip. |
| AN0190  | <b>Barraquer Needle Holder, Curved</b><br>Curved, 9mm jaws. Overall length: 130mm.           |  Barraquer Needle Holder, Curved. The image shows a close-up of the curved jaws and the full view of the instrument with a silver handle and a curved tip.          |



## NON-LOCKING NEEDLE HOLDERS

| Item #   | Description   | Image   |
|----------|---|---|
| AN0200   | <b>Barraquer Needle Holder, Curved</b><br>Curved, 10mm jaws. Overall length: 130mm.           |   |
| AN0200TI | <b>Barraquer Needle Holder, Curved</b><br>Titanium. Curved, 10mm jaws. Overall length: 136mm. |   |
| AN0170   | <b>Barraquer Needle Holder, Curved</b><br>Curved, 11mm jaws. Overall length: 130mm.           |   |
| AN0145   | <b>Barraquer Needle Holder, Curved</b><br>Curved, 9mm jaws. Overall length: 95mm.             |  |

**Castroviejo Needle Holder, Non-Locking**

Straight and curved medium 10mm jaws. No locking mechanism. Overall length: 136mm.

|        |  |  |
|--------|--|--|
| AN0260 | <b>Castroviejo Needle Holder, Curved</b><br>Curved jaws.     |  |
| AN0320 | <b>Castroviejo Needle Holder, Straight</b><br>Straight jaws. |  |







**Cohan Needle Holder**

Titanium, curved, 7.5mm fine jaws. No locking mechanism. Overall length: 104mm



|          |                            |  |
|----------|----------------------------|--|
| AN0350TI | <b>Cohan Needle Holder</b> |  |
|----------|----------------------------|--|



## NON-LOCKING NEEDLE HOLDERS

| Item #   | Description   | Image  |
|--|---|--|
| <b>McPherson Needle Holder</b>   |   |  |
| McPherson Needle Holders are available in both straight and curved 11mm jaw options. No locking mechanism. Flat, squeeze handle. Overall length: 107mm.                      |   |  |
| AN0470   | <b>Needle Holder, Curved</b><br>Strongly curved, very delicate 11mm jaws.                   |    |
| AN0490   | <b>Needle Holder, Straight</b><br>Straight, very delicate 11mm jaws.                        |    |
| <b>Needle Holder, Non-Locking</b>  |   |  |
| Various stainless steel or titanium needle holders with curved or straight shafts. Different jaw sizes and styles are available. No locking mechanism. Flat, squeeze handle. |   |  |
| AN0560   | <b>Needle Holder, Straight</b><br>Straight, 6mm extra delicate jaws. Overall length: 120mm. |   |
| AN0520   | <b>Needle Holder, Curved</b><br>Curved, 9mm extra delicate jaws. Overall length: 120mm.     |  |
| AN0625   | <b>Needle Holder, Curved</b><br>Titanium, curved, 9mm medium jaws. Overall length: 109mm.   |  |
| <b>O'Gawa Needle Holder</b>  |   |  |
| Curved, 8mm delicate jaws. No locking mechanism. Flat, squeeze handle. Overall length: 130mm.  |   |  |
| AN0525   | <b>O'Gawa Needle Holder</b>   |  |

## NON-LOCKING NEEDLE HOLDERS

| Item #  | Description                            | Image  |
|---|--|--|
| <b>Osher Needle Holder</b>  |  |  |
| Curved, 9mm delicate jaws. No locking mechanism. Flat, squeeze handle. Overall length: 110mm.   |  |  |
| AN0700  | <a href="#">Osher Needle Holder</a>    |  <p>The image shows an Osher Needle Holder, a surgical instrument with curved, delicate jaws and a flat, textured handle. An inset image provides a magnified view of the curved jaws. The instrument is marked with 'AN0700' on the handle.</p> |
| <b>Troutman Needle Holder</b>   |  |  |
| Gently curved, medium 9mm smooth jaws. No locking mechanism. Round, squeeze handle with longitudinal serrations. Overall length: 120mm. |  |  |
| AN0610  | <a href="#">Troutman Needle Holder</a> |  <p>The image shows a Troutman Needle Holder, a surgical instrument with gently curved, smooth jaws and a round handle with longitudinal serrations. The instrument is marked with 'AN0610' on the handle.</p>                                   |

# Office Instruments

## OPHTHALMIC BURRS

| Item # | Description | Image |
|--------|-------------|-------|
|--------|-------------|-------|

**Aaron Burr 2**

The Bovie Aaron Burr 2 is ideal for neurological procedures. Aaron Burr 2 includes one disposable 1mm burr tip (AXI3070) for corneal rust ring removal. An AA alkaline battery is included, and it also comes with a foam-lined case.

AXI3929 **Aaron Burr 2**

**Aaron Burr 2 Accessories**

The Bovie Aaron Burr 2 is ideal for neurological procedures. Aaron Burr 2 has various burr accessories that range in tip size.

AXI4029 **0.5mm Burr Tip**

0.5mm disposable burr tip for use with Bovie AB03, AB04, or equivalent. Sold 10 per box. Overall length: 43mm.

AXI3070 **1mm Burr Tip**

1.0mm disposable burr tip for use with Aaron Burr 2 (AXI3929) or equivalent. For corneal rust ring removal. Sold 10 per box. Overall length: 39mm.

AXI4533 **2.5mm Burr Tip**

2.5mm reusable burr tip for use with Aaron Burr 2 (AXI3929) or equivalent. Sold 1 per box. Overall length: 105mm.

AXI3930 **5mm Burr Tip**

5mm reusable diamond burr tip for use with Aaron Burr 2 (AXI3929) or equivalent. Sold 1 per box. Overall length: 127mm.

**Algerbrush II**

The Algerbrush II has a very low torque motor powered by a single AA battery. The burr in this rotary instrument is used as a "brush" rather than as a drill and the rust ring is thus "brushed" from the cornea or sclera leaving a smooth surface, which heals much faster than with other instruments used for this purpose. Algerbrush II foreign body rust ring remover. Single speed, motorized, AA battery operated handpiece. Comes with tip cover, chuck, and 0.5mm burr. Overall Length: 105mm.

AM0100 **Algerbrush II Corneal Rust Remover**

**Algerbrush II Accessories**







Accessories for the Algerbrush II foreign body rust ring remover. This includes various types and sizes of burrs as well as chucks.

AM0105 **Algerbrush Chuck**

Algerbrush II replacement chuck.







## OPHTHALMIC BURRS

| Item # | Description   | Image  |
|--------|---|--|
| AM0110 | <b>Algerbrush 0.5mm Burr</b><br>Algerbrush II 0.5mm replacement burr, burr only. Overall length: 22mm.                            |  A long, thin metal instrument with a small, rounded tip. A small inset image shows a magnified view of the tip.   |
| AM0120 | <b>Algerbrush 1.0mm Burr</b><br>Algerbrush II 1.0mm replacement burr, burr only. Overall length: 22mm.                            |  A long, thin metal instrument with a small, rounded tip. A small inset image shows a magnified view of the tip.   |
| AM0125 | <b>Algerbrush 2.5mm Ball</b><br>Algerbrush II 2.5mm replacement round, fine grit, diamond ball, tip only. Overall length: 30mm.   |  A metal instrument with a large, spherical, textured tip. A small inset image shows a magnified view of the tip.  |
| AM0126 | <b>Algerbrush 3.5mm Ball</b><br>Algerbrush II 3.5mm replacement round, medium grit, diamond ball, tip only. Overall length: 22mm. |  A metal instrument with a large, spherical, textured tip. A small inset image shows a magnified view of the tip. |
| AM0128 | <b>Algerbrush 4.0mm Wheel</b><br>Algerbrush II 4.0mm replacement fine grit, diamond wheel, tip only. Overall length: 44mm.        |  A metal instrument with a large, circular, textured tip. A small inset image shows a magnified view of the tip. |
| AM0127 | <b>Algerbrush 5.0mm Wheel</b><br>Algerbrush II 5.0mm replacement medium grit, diamond wheel, tip only. Overall length: 44mm.      |  A metal instrument with a large, circular, textured tip. A small inset image shows a magnified view of the tip. |

## FOREIGN BODY INSTRUMENTS

| Item #   | Description                    | Image  |
|--|--------------------------------|--|
| <b>Ellis Foreign Body Spud</b>   |                                |  |
| Straight shaft, curved tip, 1mm rounded blade. Flat handle. Overall length: 117mm. |                                |  |
| AH6500   | <b>Ellis Foreign Body Spud</b> |  A long, thin metal instrument with a curved tip. A small inset image shows a magnified view of the tip. |

## FOREIGN BODY INSTRUMENTS

| Item #   | Description                          | Image  |
|--|--------------------------------------|--|
| <b>Foreign Body Curette</b>  |                                      |  |
| Straight shaft, 3mm shaft, 1mm cup tip. Flat handle. Overall length: 127mm.                    |                                      |  |
| AH0260   | <a href="#">Foreign Body Curette</a> |  <p>The image shows a Foreign Body Curette, a long, thin metal instrument with a flat handle and a small, cup-shaped tip. An inset image in the top right corner provides a magnified view of the cup tip.</p>               |
| <b>Foreign Body Spud</b>   |                                      |  |
| Straight shaft, lance-shaped tip, gently curved, 2mm tip. Flat handle. Overall length: 120mm.  |                                      |  |
| AH6510   | <a href="#">Foreign Body Spud</a>    |  <p>The image shows a Foreign Body Spud, a long, thin metal instrument with a flat handle and a lance-shaped tip. An inset image in the top right corner provides a magnified view of the lance-shaped tip.</p>              |
| <b>Francis Spud</b>  |                                      |  |
| Straight shaft, flag-shaped tip with sharp edge. Flat handle. Overall length: 120mm.           |                                      |  |
| AH6520   | <a href="#">Francis Spud</a>         |  <p>The image shows a Francis Spud, a long, thin metal instrument with a flat handle and a flag-shaped tip with a sharp edge. An inset image in the top right corner provides a magnified view of the flag-shaped tip.</p> |
| <b>Golf Club Spud</b>  |                                      |  |
| Straight shaft, golf-club-shaped with sharp edge. Flat serrated handle. Overall length: 119mm. |                                      |  |
| AH6530   | <a href="#">Golf Club Spud</a>       |  <p>The image shows a Golf Club Spud, a long, thin metal instrument with a flat serrated handle and a golf-club-shaped tip with a sharp edge.</p>  |

## SCLERAL DEPRESSORS

| Item # | Description | Image |
|--------|-------------|-------|
|--------|-------------|-------|

|                                |  |  |
|--------------------------------|--|--|
| <b>Flynn Scleral Depressor</b> |  |  |
|--------------------------------|--|--|

|  |  |  |
|--|--|--|
| Pediatric size. Straight shaft, lens loop style tip. Flat serrated handle. Overall length: 80mm. |  |  |
|--|--|--|

|        |   |  |
|--------|---|--|
| AH0300 | <a href="#">Flynn Scleral Depressor</a> |  |
|--------|---|--|



|                                   |  |  |
|-----------------------------------|--|--|
| <b>Schepens Scleral Depressor</b> |  |  |
|-----------------------------------|--|--|

|   |  |  |
|---|--|--|
| Large, medium, and small Schepens Scleral Depressors are thimble shaped with 8mm wide depressor tips. Stainless steel with dull finish. Overall length: 43mm. |  |  |
|---|--|--|

|        |   |  |
|--------|---|--|
| AL1120 | <a href="#">Small Scleral Depressor</a> |  |
|        | Size 8 small thimble.                   |  |

|        |  |  |
|--------|--|--|
| AL1100 | <a href="#">Medium Scleral Depressor</a> |  |
|        | Size 10 medium thimble.                  |  |

|        |   |  |
|--------|---|--|
| AL1110 | <a href="#">Large Scleral Depressor</a> |  |
|        | Size 12 large thimble.                  |  |



|  |  |  |
|--|--|--|
| <b>Schocket Double-Ended Scleral Depressor</b> |  |  |
|--|--|--|

|   |  |  |
|---|--|--|
| Stainless steel. Slightly angled shafts, 16mm from bend to tip. T-shaped hammerhead tip on one side and ball-shaped tip on the other. Flat handle, comes with pocket clip. Overall length: 137mm. |  |  |
|---|--|--|

|        |   |  |
|--------|---|--|
| AL1130 | <a href="#">Schocket Double-Ended Scleral Depressor</a> |  |
|--------|---|--|



# Punches

A decorative horizontal bar with a blue gradient, transitioning from a darker blue on the left to a lighter blue on the right, positioned below the title.



## PUNCHES

| Item #   | Description  | Image   |
|--|--|---|
| <b>Kelly Descemet's Membrane Punch</b>   |  |   |
| Stainless steel Kelly Descemet's Membrane Punch produces round punches without tissue tags. Punches have serrated squeeze action handles. Overall length: 130mm. |  |   |
| AM0410   | <b>0.75mm Membrane Punch</b><br>Produces an exact 0.75mm round hole. |  A stainless steel Kelly Descemet's Membrane Punch, shown from a side-on perspective. It features two long, serrated handles that meet at a central point, forming a V-shape. The handles are made of polished metal and have a textured, serrated surface for grip. The central part of the punch is a thin, flat metal strip. |
| AM0410 1.00  | <b>1.0mm Membrane Punch</b><br>Produces an exact 1.0mm round hole.   |   |

# Retinal Picks

## RETINAL PICKS

| Item #  | Description   | Image  |
|---|---|--|
| <b>Olk Angled Retinal Pick</b>  |   |  |
| Straight shaft, 0.5mm angled tip, squared. Round handle. Overall length: 125mm. |   |  |
| AH5290  | <b>110-Degree Retinal Pick</b><br>110-degree tip angle. |  |
| AH5310  | <b>150-Degree Retinal Pick</b><br>150-degree tip angle. |  |

# Scissors

A decorative horizontal bar with a blue gradient, transitioning from a darker blue on the left to a lighter blue on the right.

CORNEAL SCISSORS

Item # Description Image

Aebli Corneal Scissors

Angled and straight blades and universal standard pattern with blunt tips.

AS0120 Aebli Corneal Scissors, Straight
Straight 19mm blades. Ring handle. Overall length: 92mm.



AS0110 Aebli Corneal Scissors, Straight
Straight 21mm blades. Ribbon handle. Overall length: 99mm.



AS0100 Aebli Corneal Scissors, Angled
Angled 21mm blades. Ribbon handle. Overall length: 99mm.



Aebli Corneal Section Scissors

Angled left and right 18mm blades, blunt tips. Flat, squeeze handle. Overall length: 120mm.

AS0310 Aebli Corneal Scissors, Angled Right
Angled right blades.



## CORNEAL SCISSORS

| Item # | Description   | Image  |
|--------|---|--|
| AS0320 | <b>Aebli Corneal Scissors, Angled Left</b><br>Angled left blades. |  A pair of stainless steel corneal scissors with angled left blades. The handles are light-colored with a textured grip. An inset image shows a close-up of the blades. The item number AS0320 is visible on the handle. |

**Manson-Aebli Corneal Scissors**

Angled left and right 19mm blades, lower blade 1.5mm longer than upper blade, blunt tips. Flat squeeze handle. Overall length: 120mm.

|        |   |   |
|--------|---|---|
| AS1115 | <b>Corneal Scissors, Angled Right</b><br>Angled right blades. |  A pair of stainless steel corneal scissors with angled right blades. The handles are light-colored with a textured grip. An inset image shows a close-up of the blades. The item number AS1105 is visible on the handle. |
| AS1105 | <b>Corneal Scissors, Angled Left</b><br>Angled left blades.   |   |

**Azar Corneal Scissors**

Curved 16mm blades, universal medium model, blunt tips, calibration marks at 1mm to 6mm. Flat handle. Overall length: 115mm.

|        |                              |   |
|--------|------------------------------|---|
| AS0130 | <b>Azar Corneal Scissors</b> |  A pair of stainless steel corneal scissors with curved blades. The handles are light-colored with a textured grip. The item number AS0130 is visible on the handle. |
|--------|------------------------------|---|



**Barraquer Corneal Section Scissors**

Angled left and right 19 mm blades, 45-degree angle, blunt tips. Flat squeeze handle, locking handle.





|        |   |  |
|--------|---|--|
| AS1110 | <b>Left Section Scissors</b><br>Angled left blades.   |  A pair of stainless steel Barraquer corneal section scissors with angled blades and a locking handle. The handles are light-colored with a textured grip. An inset image shows a close-up of the blades. The item number AS1120 is visible on the handle. |
| AS1120 | <b>Right Section Scissors</b><br>Angled right blades. |  |

**Castroviejo Corneal Scissors**

Curved and angled blades with blunt tips and flat squeeze handle.



|        |   |   |
|--------|---|---|
| AS0150 | <b>Castroviejo Corneal Scissors, Miniature</b><br>Curved 11mm blades, universal miniature model, fine tips.<br>Overall length: 106mm. |  A pair of stainless steel miniature Castroviejo corneal scissors with curved blades. The handles are light-colored with a textured grip. The item number AS0150 is visible on the handle.  |
| AS0180 | <b>Castroviejo Corneal Scissors, Miniature</b><br>Curved left 11mm blades, miniature model. Overall length: 106mm.                    |  A pair of stainless steel miniature Castroviejo corneal scissors with curved blades. The handles are light-colored with a textured grip. An inset image shows a close-up of the blades. The item number AS0180 is visible on the handle. |

## CORNEAL SCISSORS





| Item # | Description   | Image  |
|--------|---|--|
| AS0190 | <b>Castroviejo Corneal Scissors, Miniature</b><br>Curved right 11mm blades, miniature model. Overall length: 106mm.                     |  A pair of miniature corneal scissors with curved right blades. The handle has a textured grip and the model number AS0190 is visible. An inset image shows the tip of the blades. |
| AS0140 | <b>Castroviejo Corneal Scissors, Miniature</b><br>Straight 19mm blades, universal miniature model. Overall length: 106mm.               |  A pair of miniature corneal scissors with straight blades. The handle has a textured grip and the model number AS0140 is visible.   |
| AS0200 | <b>Castroviejo Corneal Scissors, Medium</b><br>Strong curved 16mm blades, universal medium model. Overall length: 115mm.                |  A pair of medium-sized corneal scissors with strong curved blades. The handle has a textured grip and the model number AS0200 is visible.   |
| AS0170 | <b>Castroviejo Corneal Scissors, Medium</b><br>Medium curved 16mm blades, universal medium model. Overall length: 115mm.                |  A pair of medium-sized corneal scissors with medium curved blades. The handle has a textured grip and the model number AS0170 and CE mark are visible.                           |
| AS0160 | <b>Castroviejo Corneal Scissors, Medium</b><br>Medium curved 16mm blades, universal medium model. 3-hole handle. Overall length: 115mm. |  A pair of medium-sized corneal scissors with medium curved blades and a 3-hole handle. The handle has a textured grip and the model number AS0160 and CE mark are visible.      |

## Castroviejo Corneal Section Scissors

Curved and angled blades with flat squeeze handle.

|        |   |  |
|--------|---|--|
| AS1150 | <b>Castroviejo Corneal Scissors, Left</b><br>Curved left 9mm blades, lower blade 0.5mm longer than upper blade, sub-miniature model, blunt tips. Overall length: 103mm.   |  A pair of sub-miniature corneal section scissors with curved left blades. The handle has a textured grip and the model number AS1150 is visible. An inset image shows the tip of the blades.  |
| AS1200 | <b>Castroviejo Corneal Scissors, Right</b><br>Curved right 9mm blades, lower blade 0.5mm longer than upper blade, sub-miniature model, blunt tips. Overall length: 103mm. |  A pair of sub-miniature corneal section scissors with curved right blades. The handle has a textured grip and the model number AS1200 is visible. An inset image shows the tip of the blades. |
| AS1160 | <b>Castroviejo Corneal Scissors, Left</b><br>Curved left 13mm blades, lower blade 0.5mm longer than upper blade, mid-miniature model, blunt tips. Overall length: 106mm.  |  A pair of mid-miniature corneal section scissors with curved left blades. The handle has a textured grip and the model number AS1160 is visible. An inset image shows the tip of the blades.  |

## CORNEAL SCISSORS

| Item # | Description   | Image  |
|--------|---|--|
| ASI210 | <b>Castroviejo Corneal Scissors, Right</b><br>Curved right 13mm blades, mid-miniature model, lower blade 0.5mm longer than upper blade, blunt tips. Overall length: 106mm.                        |    |
| ASI170 | <b>Castroviejo Corneal Scissors, Left</b><br>Angled left 14mm blades, blunt tips, lower blade 0.5mm longer than upper blade. Overall length: 106mm.   |    |
| ASI220 | <b>Castroviejo Corneal Scissors, Right</b><br>Angled right 14mm blades, blunt tips, lower blade 0.5mm longer than upper blade. Overall length: 106mm.   |    |
| ASI140 | <b>Castroviejo Corneal Scissors, Left</b><br>Angled left 18mm blades, curved to conform to the curve of the limbus, lower blade 1mm longer than upper blade, blunt tips. Overall length: 112mm.   |   |
| ASI190 | <b>Castroviejo Corneal Scissors, Right</b><br>Angled right 18mm blades, curved to conform to the curve of the limbus, lower blade 1mm longer than upper blade, blunt tips. Overall length: 112mm. |  |

## Castroviejo Keratoplasty Scissors

Angled to side 16mm blades, universal model, medium, lower blade 1mm longer than upper blade, blunt tips. Flat handle. Overall length: 110mm.

|        |  |  |
|--------|--|--|
| AS0210 | <b>Castroviejo Keratoplasty Scissors</b> |  |
|--------|--|--|





## Hoffer-Stern Scissors

Angled forward 10mm blades, extra thin, blunt tips. Flat, serrated handle. Overall length: 112mm.





|        |                                     |  |
|--------|-------------------------------------|--|
| AS5560 | <b>Hoffer-Stern Curved Scissors</b> |  |
|--------|-------------------------------------|--|



**CORNEAL SCISSORS**

| Item #   | Description  | Image  |
|--|--|--|
| <b>Katzin Corneal Transplant Scissors</b>  |  |  |
| Curved left and right blades, lower blade 12mm, upper blade 11mm, miniature model, blunt tips. Flat 3-hole, squeeze handle. Overall length: 108mm. |  |  |
| AS0220   | <b>Katzin Curved Corneal Scissors, Right</b><br>Strongly curved right blades.              |   |
| AS0230   | <b>Katzin Curved Corneal Scissors, Left</b><br>Strongly curved left blades.                |  |
| <b>Troutman-Castroviejo Corneal Section Scissors</b>   |  |  |
| Curved left and right 13mm blades, miniature model, blunt tips. Flat handle, locking handle.   |  |  |
| AS1270   | <b>Troutman-Castroviejo Scissors, Left</b><br>Curved left blades. Overall length: 116mm.   |   |
| AS1290   | <b>Troutman-Castroviejo Scissors, Right</b><br>Curved right blades. Overall length: 105mm. |  |
| <b>Troutman-Katzin Corneal Transplant Scissors</b>   |  |  |
| Strongly curved left blades, small, blunt tips. Flat, 3-hole, locking handle. Overall length: 105mm.   |  |  |
| AS0290   | <b>Troutman-Katzin Corneal Scissors</b>  |    |



**ENUCLEATION SCISSORS**

| Item #   | Description   | Image  |
|--|---|--|
| <b>Enucleation Scissors</b>  |   |  |
| Curved blades, heavy, blunt, rounded tips. Ring handle. Overall length: 131mm. |   |  |
| AS2120   | <b>Enucleation Scissors, Strong Curve</b><br>Strongly curved 40mm blades. |   |
| AS2110   | <b>Enucleation Scissors, Medium Curve</b><br>Medium curved 44mm blades.   |  |
|  |   |   |



ENUCLEATION SCISSORS

| Item # | Description  | Image  |
|--------|--|--|
| AS2100 | <p data-bbox="261 321 566 346"><b>Enucleation Scissors, Light Curve</b></p> <p data-bbox="261 354 513 380">Lightly curved 44mm blades.</p> |  |



EYE SCISSORS

| Item #  | Description  | Image  |
|---|--|--|
| <b>Eye Scissors</b>                               |  |  |
| Straight and curved blades, 29mm and 30mm blades. |  |  |
| AS5130  | <p data-bbox="261 779 451 804"><b>Eye Scissors, Curved</b></p> <p data-bbox="261 812 743 858">Curved 29mm blades, blunt tips. Ribbon handle. Overall length: 107mm.</p>                  |   |
| AS5120  | <p data-bbox="261 1161 461 1186"><b>Eye Scissors, Straight</b></p> <p data-bbox="261 1194 764 1241">Straight 29mm blades, sharp, pointed tips. Ribbon handle. Overall length: 109mm.</p> |  |
| AS5160  | <p data-bbox="261 1543 461 1568"><b>Eye Scissors, Straight</b></p> <p data-bbox="261 1577 743 1623">Straight 29mm blades, round, blunt tips. Ribbon handle. Overall length: 107mm.</p>   |  |



EYE SCISSORS

| Item # | Description   | Image   |
|--------|---|---|
| AS5140 | <p><b>Eye Scissors, Curved</b></p> <p>Curved 30mm blades, sharp tips. Ring handle. Overall length: 109mm.</p>     |   |
| AS5170 | <p><b>Eye Scissors, Straight</b></p> <p>Straight 30mm blades, sharp tips. Ring handle. Overall length: 109mm.</p> |  |

INTRAOCULAR SCISSORS

| Item #   | Description   | Image  |
|--|---|--|
| <b>Intraocular Scissors</b>  |   |  |
| Microscissors with straight tubular shafts available with straight or curved 2mm blades. All scissors have titanium, squeeze-action handles. |   |  |
| AS2310   | <p><b>Intraocular Scissors, Curved</b></p> <p>Curved blades. Overall length: 146mm.</p>     |  |
| AS2320   | <p><b>Intraocular Scissors, Angled</b></p> <p>Angled blades. Overall length: 146mm.</p>     |  |
| AS2390   | <p><b>Intraocular Scissors, Straight</b></p> <p>Straight blades. Overall length: 146mm.</p> |  |



## INTRAOCULAR SCISSORS

| Item # | Description   | Image   |
|--------|---|---|
| AS0940 | <b>Intraocular Scissors, Angled</b><br>23g shaft, angled 45 degree blades. For cutting parallel to the retina. Overall length: 134mm. |  A pair of blue-handled intraocular scissors with angled blades. An inset image shows a close-up of the blades.   |
| AS0900 | <b>Intraocular Scissors, Straight</b><br>23g shaft, straight blades. Overall length: 142mm.   |  A pair of blue-handled intraocular scissors with straight blades. An inset image shows a close-up of the blades. |







## IOL REMOVAL SCISSORS

| Item #   | Description                | Image  |
|--|----------------------------|--|
| <b>Accutome IOL Cutter</b>   |                            |  |
| Accutome cutter for the explanting, or removal, of an IOL. Angled left 7mm blades, rounded, blunt tips. Flat handle. Overall length: 92mm. |                            |  |
| AS0301   | <b>Accutome IOL Cutter</b> |  A pair of stainless steel IOL cutters with a flat handle and angled blades. The handle has 'AS0301 CE' engraved on it. |











## IRIS SCISSORS

| Item #  | Description                              | Image  |
|---|--|--|
| <b>Barraquer Iris Scissors</b>  |  |  |
| Angled 7.5mm blades, delicate, blunt tips. Flat, squeeze-action handle. Overall length: 54mm. |  |  |
| AS3100  | <b>Barraquer Iris Scissors</b>           |  A pair of Barraquer iris scissors with a light-colored handle and angled blades.  |
| <b>Cohan-Vannas Curved Iris Scissors</b>  |  |  |
| Straight 12mm blades, sharp, pointed tips. Flat, squeeze handle. Overall length: 57mm.        |  |  |
| AS3110  | <b>Cohan-Vannas Curved Iris Scissors</b> |  A pair of stainless steel Cohan-Vannas curved iris scissors with a flat handle and curved blades. An inset image shows a close-up of the blades. The handle has 'AS3110 CE' engraved on it. |

## IRIS SCISSORS

| Item #   | Description  | Image  |
|--|--|--|
| <b>DeWecker Iris Scissors</b>                                    |  |  |
| Angled 12mm blades. Flat, squeeze handle. Overall length: 114mm. |  |  |
| AS3120   | <b>Blunt Iris Scissors</b><br>Blunt tip blades.  |    |
| AS3130   | <b>Sharp Iris Scissors</b><br>Sharp and blunt tip blades.  |    |
| <b>Iris Scissors</b>   |  |  |
| Straight and curved blades with sharp, pointed tips.             |  |  |
| AS3185   | <b>Iris Scissors, Straight</b><br>Straight 10mm blades. Flat, 3-hole, squeeze handle. Overall length: 108mm. |   |
| AS3190   | <b>Iris Scissors, Straight</b><br>Straight 18mm blades. Ribbon handle. Overall length: 99mm.                 |  |
| AS3160   | <b>Iris Scissors, Curved</b><br>Curved 18mm blades. Ribbon handle. Overall length: 99mm.                     |  |
| AS4110   | <b>Iris Scissors, Curved</b><br>Curved 21mm blades. Flat, squeeze handle. Overall length: 121mm.             |  |
| AS4100   | <b>Iris Scissors, Straight</b><br>Straight 21mm blades. Flat, squeeze handle. Overall length: 121mm.         |  |

## IRIS SCISSORS

| Item # | Description  | Image   |
|--------|--|---|
| AS5180 | <b>Iris Scissors, Straight</b><br>Straight 25mm blades, light standard pattern. Ring handle. Overall length: 98mm. | <br>     |
| AS5150 | <b>Iris Scissors, Curved</b><br>Curved 25mm blades, light standard pattern. Ring handle. Overall length: 98mm.     |   |
| AS3140 | <b>Iris Scissors, Curved</b><br>Curved 25mm blades. Large ring handle. Overall length: 102mm.                      |   |
| AS3170 | <b>Iris Scissors, Straight</b><br>Straight 28mm blades. Large ring handle. Overall length: 100mm.                  | <br>    |
| AS3210 | <b>Iris Scissors, Straight</b><br>Straight 29mm blades. Ribbon handle. Overall length: 105mm.                      | <br> |
| AS3220 | <b>Iris Scissors, Curved</b><br>Curved 29mm blades. Ribbon handle. Overall length: 105mm.                          |   |
| AS5110 | <b>Iris Scissors, Curved</b><br>Curved 30mm blades. Ring handle. Overall length: 108mm.                            |   |

**McPherson-Vannas Iris Scissors**

Curved 11mm blades, delicate, sharp tips. Flat, squeeze handle. Overall length: 83mm.

|        |                                       |   |
|--------|---------------------------------------|---|
| AS3200 | <b>McPherson-Vannas Iris Scissors</b> | <br> |
|--------|---------------------------------------|---|

## MISCELLANEOUS SCISSORS

| Item # | Description | Image |
|--------|-------------|-------|
|--------|-------------|-------|

**Mayo Dissecting Scissors**

Straight 58mm blades, beveled, blunt tips. Ring handle. Overall length: 171mm.

|        |  |  |
|--------|--|--|
| AS5235 | <a href="#">Mayo Dissecting Scissors</a> |  |
|--------|--|--|

**Troutman Conjunctival Scissors**

Curved 17mm blades, blunt tips. Flat, locking handle. Overall length: 107mm.

|        |  |  |
|--------|--|--|
| AS5910 | <a href="#">Troutman Conjunctival Scissors</a> |  |
|--------|--|--|

**Westcott Conjunctival Scissors**

Lightly curved 16mm blades, blunt tips. Flat, wide, squeeze handle. Overall length: 132mm.

|        |  |  |
|--------|--|--|
| AS4580 | <a href="#">Westcott Conjunctival Scissors</a> |  |
|--------|--|--|



## STITCH SCISSORS

| Item # | Description | Image |
|--------|-------------|-------|
|--------|-------------|-------|

**Castroviejo Mini Keratoplasty-Utility-Stitch Scissors**

Curved 13mm blades, miniature model, small, sharp, pointed tips. Flat handle, wide. Overall length: 131mm.

|        |  |  |
|--------|--|--|
| AS5100 | <a href="#">Castroviejo Mini Keratoplasty Scissors</a> |  |
|--------|--|--|













**STITCH SCISSORS**

| Item #   | Description  | Image   |
|--|--|---|
| <b>Westcott Type Stitch Scissors</b>                                   |  |   |
| Curved blades with sharp, pointed tips. Flat, serrated squeeze handle. |  |   |
| AS4190   | <p data-bbox="261 432 467 457"><b>Curved Stitch Scissors</b></p> <p data-bbox="261 466 643 491">Curved 21mm blades. Overall length: 116mm.</p>                 |  <p>The image shows a pair of Westcott type curved stitch scissors. It features two curved blades with sharp, pointed tips. The handle is flat and has a serrated texture for grip. A small inset image shows a close-up of the blade tip. The overall length is 116mm.</p>                 |
| AS4200   | <p data-bbox="261 621 537 646"><b>Lightly Curved Stitch Scissors</b></p> <p data-bbox="261 655 716 680">Lightly curved 22mm blades. Overall length: 140mm.</p> |  <p>The image shows a pair of Westcott type lightly curved stitch scissors. It features two lightly curved blades with sharp, pointed tips. The handle is flat and has a serrated texture for grip. A small inset image shows a close-up of the blade tip. The overall length is 140mm.</p> |

**STRABISMUS SCISSORS**

| Item #  | Description  | Image   |
|---|--|---|
| <b>Knapp Strabismus Scissors</b>  |  |   |
| Straight and curved blades, 25mm blades, rounded, blunt tips. Ring handle. Overall length: 118mm. |  |   |
| AS3500  | <p data-bbox="261 1079 586 1104"><b>Knapp Strabismus Scissors, Curved</b></p> <p data-bbox="261 1113 456 1138">Lightly curved blades.</p>  |  <p>The image shows a pair of Knapp strabismus scissors with curved blades. It has two ring handles and a straight handle. The blades are curved and have rounded, blunt tips. The overall length is 118mm.</p>                   |
| AS3510  | <p data-bbox="261 1461 586 1486"><b>Knapp Strabismus Scissors, Curved</b></p> <p data-bbox="261 1495 456 1520">Strongly curved blades.</p> |  <p>The image shows a pair of Knapp strabismus scissors with strongly curved blades. It has two ring handles and a straight handle. The blades are strongly curved and have rounded, blunt tips. The overall length is 118mm.</p> |

**STRABISMUS SCISSORS**

| Item # | Description  | Image  |
|--------|--|--|
| AS3520 | <b>Knapp Strabismus Scissors, Straight</b><br>Straight blades. |  |

**Strabismus Scissors**



Curved and straight blades, rounded, blunt tips. Ribbon handle. Overall length: 109mm.

|        |  |  |
|--------|--|--|
| AS3550 | <b>Strabismus Scissors, Straight</b><br>Straight 29mm blades.      |      |
| AS3530 | <b>Strabismus Scissors, Curved</b><br>Curved 29mm blades.          |    |
| AS3540 | <b>Strabismus Scissors, Curved</b><br>Strongly curved 27mm blades. |   |



**SUTURE SCISSORS**

| Item #   | Description                        | Image  |
|--|------------------------------------|--|
| <b>Littler Suture/Dissecting Scissors</b>  |                                    |  |
| Curved 27mm blades, holes in blades, round blunt tips. Ring handle. Overall length: 121mm. |                                    |  |
| AS5900   | <b>Littler Dissecting Scissors</b> |   |





**SUTURE SCISSORS**

| Item #                           | Description  | Image  |
|----------------------------------|--|--|
| <b>Stitch Removal Scissors</b>   |  |  |
| Straight blades with sharp tips. |  |  |
| AS4170                           | <p data-bbox="261 432 566 457"><b>Stitch Removal Scissors, Straight</b></p> <p data-bbox="261 468 773 516">Straight blades, sharp tips, delicate. Ribbon handle. Overall length: 99mm.</p>                   |  |
| AS4130                           | <p data-bbox="261 814 566 840"><b>Stitch Removal Scissors, Straight</b></p> <p data-bbox="261 850 716 898">Straight 16mm blades, sharp, pointed tips. Flat, wide, squeeze handle. Overall length: 132mm.</p> |  |





**TENOTOMY SCISSORS**

| Item #   | Description  | Image  |
|--|--|--|
| <b>McPherson-Westcott Tenotomy Scissors</b>  |  |  |
| Curved right 9mm blades, sub-miniature model, rounded, blunt tips. Flat, squeeze handle. Overall length: 88mm. |  |  |
| AS0240   | <p data-bbox="261 1270 633 1295"><b>McPherson-Westcott Tenotomy Scissors</b></p> |  |
| <b>Shepard-Westcott Tenotomy Scissors</b>  |  |  |
| Curved right 21mm blades, blunt tips, upper blade serrated. Flat, squeeze handle. Overall length: 123mm.       |  |  |
| AS4510   | <p data-bbox="261 1575 607 1600"><b>Shepard-Westcott Tenotomy Scissors</b></p>   |  |

TENOTOMY SCISSORS

| Item #                                      | Description   | Image  |
|---|---|--|
| <b>Stevens Tenotomy Scissors</b>            |   |  |
| Straight and curved blades with blunt tips. |   |  |
| AS4550                                      | <p data-bbox="261 432 597 457"><b>Stevens Tenotomy Scissors, Straight</b></p> <p data-bbox="261 466 779 512">Straight 19mm blades, heavy model, blunt tips. Ring handle. Overall length: 98mm.</p>          |    |
| AS4560                                      | <p data-bbox="261 816 597 842"><b>Stevens Tenotomy Scissors, Straight</b></p> <p data-bbox="261 850 786 896">Straight 19mm blades, light model, blunt tips. Ribbon handle. Overall length: 98mm.</p>        |   |
| AS4520                                      | <p data-bbox="261 1201 586 1226"><b>Stevens Tenotomy Scissors, Curved</b></p> <p data-bbox="261 1234 786 1281">Curved 19mm blades, heavy model, blunt, round tips. Ribbon handle. Overall length: 98mm.</p> |  |
| AS4530                                      | <p data-bbox="261 1585 586 1610"><b>Stevens Tenotomy Scissors, Curved</b></p> <p data-bbox="261 1619 779 1665">Curved 19mm blades, light model, blunt tips. Ribbon handle. Overall length: 98mm.</p>        |  |

## TENOTOMY SCISSORS

| Item # | Description   | Image  |
|--------|---|--|
| AS4575 | <p><b>Stevens Tenotomy Scissors, Curved</b></p> <p>Curved 33mm blades, blunt tips. Ring handle. Overall length: 143mm.</p>                                      |    |
| AS4576 | <p><b>Stevens Tenotomy Scissors, Curved</b></p> <p>Curved 36mm blades, blunt tips. Ring handle. Overall length: 159mm.</p>                                      |   |
| AS4570 | <p><b>Stevens Tenotomy Scissors, Straight</b></p> <p>Straight, standard blades 30mm from mid-screw to tips, blunt tips. Ring handle. Overall length: 112mm.</p> |  |
| AS4540 | <p><b>Stevens Tenotomy Scissors, Curved</b></p> <p>Curved, standard blades, 30mm from mid-screw to tip, blunt tips. Ring handle. Overall length: 112mm.</p>     |  |

## TENOTOMY SCISSORS

| Item #  | Description   | Image   |
|---|---|---|
| <b>Westcott Tenotomy Scissors</b>                               |   |   |
| Curved left and right blades, blunt tips. Flat, squeeze handle. |   |   |
| AS4590  | <b>Westcott Tenotomy Scissors, Curved</b><br>Curved 15mm blades, medium, blunt tips. 3-hole handle. Overall length: 118mm.          | A pair of stainless steel tenotomy scissors with curved blades and a black handle with three finger loops. An inset image shows the tip of the blades.  |
| AS4600  | <b>Westcott Tenotomy Scissors, Curved Left</b><br>Curved left 19mm blades, rounded, blunt tips. Overall length: 115mm.              | A pair of stainless steel tenotomy scissors with curved blades, the left blade being longer than the right. The handle is black with a textured grip. An inset image shows the tip of the blades.       |
| AS4610  | <b>Westcott Tenotomy Scissors, Curved Right</b><br>Curved right 19mm blades, blunt tips. Overall length: 115mm.                     | A pair of stainless steel tenotomy scissors with curved blades, the right blade being longer than the left. The handle is black with a textured grip. An inset image shows the tip of the blades.       |
| AS4620  | <b>Westcott Tenotomy Scissors, Curved Right</b><br>Curved right 23mm blades, round, blunt tips. Wide handle. Overall length: 143mm. | A pair of stainless steel tenotomy scissors with curved blades, the right blade being longer than the left. The handle is black with a wide, textured grip. An inset image shows the tip of the blades. |

## UTILITY SCISSORS

| Item #                                       | Description  | Image  |
|--|--|--|
| <b>Lister Bandage Scissors</b>               |  |  |
| Angled blades, probe point tip. Ring handle. |  |  |
| AS6515                                       | <b>50mm Bandage Scissors</b><br>50mm blade from mid-screw to tip. Overall length: 119mm. | A pair of stainless steel bandage scissors with angled blades and a ring handle. An inset image shows the tip of the blades. |
| AS6516                                       | <b>67mm Bandage Scissors</b><br>67mm blade from mid-screw to tip. Overall length: 181mm. | A pair of stainless steel bandage scissors with angled blades and a ring handle. An inset image shows the tip of the blades. |



## UTILITY SCISSORS



| Item # | Description   | Image  |
|--------|---|--|
| AS5250 | <p><b>Utility Scissors, Angled</b></p> <p>Angled 26mm blades, probe points, blunt tips. Ring handle. Overall length: 116mm.</p> |  |

**Westcott Type Utility Scissors**

Curved 25mm blades, rounded tips, sharp. Flat handle. Overall length: 131mm.





|        |  |  |
|--------|--|--|
| AS5210 | <p><b>Westcott Type Utility Scissors</b></p> |  |
|--------|--|--|

## VANNAS SCISSORS















| Item #   | Description  | Image  |
|--|--|--|
| <b>Gills-Vannas Capsulotomy Scissors</b>                                     |  |  |
| 7mm blades, sharp, pointed tips. Flat, squeeze handle. Overall length: 89mm. |  |  |
| AS5510   | <p><b>Gills-Vannas Capsulotomy Scissors, Angled</b></p> <p>Angled forward blades. 3-hole handle.</p> |  |
| AS5530   | <p><b>Gills-Vannas Capsulotomy Scissors, Straight</b></p> <p>Straight blades.</p>                    |  |
| AS5520   | <p><b>Gills-Vannas Capsulotomy Scissors, Curved</b></p> <p>Curved blades.</p>                        |  |



## VANNAS SCISSORS

| Item #  | Description   | Image   |
|---|---|---|
| <b>Gills-Welsh-Vannas Micro Scissors</b>  |   |   |
| Angled blades, sharp, pointed tips. Flat, squeeze handle.   |   |   |
| AS5540  | <b>5mm Gills-Welsh-Vannas Scissors</b><br>5mm blades. Overall length: 80mm.   |  <p>The image shows a pair of 5mm Gills-Welsh-Vannas Scissors. It features a pair of angled blades with sharp, pointed tips. The handle is flat and has a textured grip. A small inset image in the top left corner provides a magnified view of the blade tip. The item number 'AS5540' is visible on the handle.</p>  |
| AS5550  | <b>11mm Gills-Welsh-Vannas Scissors</b><br>11mm blades. Overall length: 86mm. |  <p>The image shows a pair of 11mm Gills-Welsh-Vannas Scissors. It features a pair of angled blades with sharp, pointed tips. The handle is flat and has a textured grip. The item number 'AS5550' is visible on the handle.</p>  |
| <b>Stern-Gills Scissors</b>   |   |   |
| Angled forward 10mm blades, extra-thin, sharp tips. Flat, 3-hole squeeze handle. Overall length: 112mm. |   |   |
| AS5570  | <b>Stern-Gills Scissors</b>   |  <p>The image shows a pair of Stern-Gills Scissors. It features a pair of angled forward 10mm blades, which are extra-thin and have sharp tips. The handle is flat and has three circular holes for a squeeze grip. The overall length is 112mm.</p>   |
| <b>Uribe-Stern Scissors</b>   |   |   |
| Curved forward 10mm blades, extra-thin, sharp tips. Flat, 3-hole squeeze handle. Overall length: 112mm. |   |   |
| AS5580  | <b>Uribe-Stern Scissors</b>   |  <p>The image shows a pair of Uribe-Stern Scissors. It features a pair of curved forward 10mm blades, which are extra-thin and have sharp tips. The handle is flat and has three circular holes for a squeeze grip. A small inset image in the top left corner provides a magnified view of the blade tip. The item number 'AS5580' is visible on the handle.</p> |
| <b>Uthoff-Gills Capsulotomy Scissors</b>  |   |   |
| Angled 10mm blades, curved, blunt tips. Flat, squeeze handle.   |   |   |
| AS5590  | <b>Uthoff-Gills Capsulotomy Scissors</b>                                      |  <p>The image shows a pair of Uthoff-Gills Capsulotomy Scissors. It features a pair of angled 10mm blades that are curved and have blunt tips. The handle is flat and has a textured grip. A small inset image in the top left corner provides a magnified view of the blade tip.</p>   |

## VANNAS SCISSORS

| Item #   | Description   | Image   |
|--|---|---|
| <b>Vannas Capsulotomy Scissors</b>   |   |   |
| 6mm blades, sharp pointed tips. Flat, squeeze handle.  |   |   |
| AS5610   | <b>Vannas Capsulotomy Scissors, Angled</b><br>30-degree angled blades, sharp, pointed tips. Overall length: 81mm. | <br>     |
| AS5640   | <b>Vannas Capsulotomy Scissors, Curved</b><br>Curved blades. Overall length: 86mm.                                | <br>     |
| AS5680   | <b>Vannas Capsulotomy Scissors, Straight</b><br>Straight blades. Overall length: 84mm.                            | <br>     |
| AS5600   | <b>Vannas Capsulotomy Scissors, Angled</b><br>Blades angled to side. Overall length: 81mm.                        | <br> |
| <b>Vannas Scissors</b>   |   |   |
| Curved and straight blades with extra-thin, sharp, pointed tips. Flat, 3-hole squeeze handle. Overall length: 112mm. |   |   |
| AS5660   | <b>Vannas Scissors, Straight</b><br>Straight 7mm blades.  | <br> |
| AS5630   | <b>Vannas Scissors, Curved</b><br>Curved 7mm blades.  | <br> |
| AS5670   | <b>Vannas Scissors, Straight</b><br>Straight 10mm blades.   | <br> |

VANNAS SCISSORS

| Item # | Description  | Image  |
|--------|--|--|
| AS5650 | <a href="#">Vannas Scissors, Curved</a><br>Curved 10mm blades. |  |

# Spatulas

The image features a dark blue background with a faint, light blue grid pattern. A prominent curved gradient bar, transitioning from light blue to dark blue, arches across the upper portion of the frame. Below the main title, there are two horizontal bars: a solid medium-blue bar and a lighter blue gradient bar.

CYCLODIALYSIS SPATULAS

| Item # | Description | Image |
|--------|-------------|-------|
|--------|-------------|-------|

**Barraquer Cyclodialysis Spatula**

Angled shaft, 0.5mm x 15mm angled round blade, smooth, pointed tip, slightly curved blade. Round handle. Overall length: 120mm.



**Castroviejo Cyclodialysis Spatula**

Double-ended and single-ended, angled shafts. Flat handle.

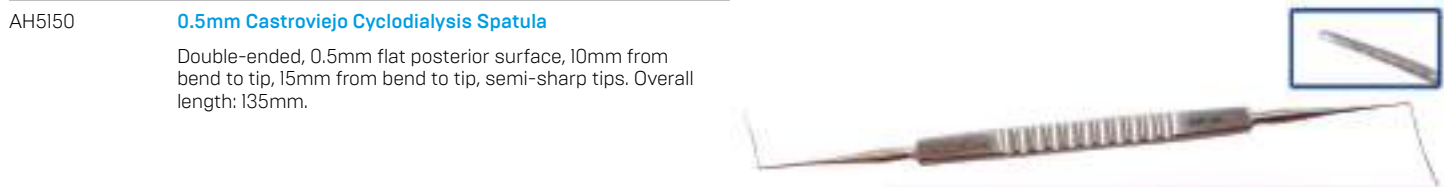

**Castroviejo Synechia Spatula**

Double-ended, angled shafts, 0.5mm spatulas, 15mm from bend to tip, 10mm from bend to tip. Flat handle. Overall length: 133mm.





## CYCLODIALYSIS SPATULAS

| Item #  | Description                                    | Image  |
|---|--|--|
| <b>Wheeler/Elschnig Cyclo dialysis Spatula</b>  |  |  |
| Double-ended, curved shaft, 1.75mm spatula, 30mm from bend to tip on both ends. Flat handle. Overall length: 140mm. |  |  |
| AH5370  | <a href="#">Wheeler Cyclo dialysis Spatula</a> |  |

## DSEK SPATULAS

| Item #  | Description                                | Image   |
|---|--|---|
| <b>Cindy Sweeper DSEK Spatula</b>   |  |   |
| Angled shaft, 0.7mm spatula, 12mm from bend to tip, cylindrical smooth tip, blunt. Round handle. Overall length: 114mm. |  |   |
| AH7201  | <a href="#">Cindy Sweeper DSEK Spatula</a> |  |

## FEMTOSECOND SPATULAS

| Item #   | Description   | Image  |
|--|---|--|
| <b>Eippert Femtosecond Spatula</b>   |   |  |
| This stainless steel Eippert Femtosecond Spatula is double-ended for greater versatility and has straight shafts with 0.9mm and 2.0mm blunt thin tips to maintain proper wound architecture. Helps to ensure open incisions after femtosecond laser incisions. |   |  |
| AH4605   | <a href="#">Eippert Femtosecond Spatula, Long</a><br>Long, round handle design that is ideal for use during femtosecond laser surgery. Overall length: 146mm. |  |
| AH4606   | <a href="#">Eippert Femtosecond Spatula, Short</a><br>Short, round handle design that is ideal for use with the aberrometer. Overall length: 120mm.           |  |

## FEMTOSECOND SPATULAS

| Item # | Description | Image |
|--------|-------------|-------|
|--------|-------------|-------|

|  |  |  |
|--|--|--|
| <b>Lane Femtosecond Incisional Spatula</b> |  |  |
|--|--|--|

Double-ended Lane femtosecond cataract incisional spatula is specifically designed for opening femtosecond-created primary, secondary, and arcuate incisions in cataract surgery. One end is used to open and spread the vertical/tangential component of the femtosecond-created incision and the other end is used to open the tunnel aspect of the incision entry into the anterior chamber. Double-ended, one-angled shaft with blunt spatulated tip, 10mm from bend to tip, max depth of 0.25mm. One straight shaft with 90-degree angle, curved spatulated tip. Round handle. Overall length: 125mm.

AH6610

Lane Femtosecond Spatula



|                                |  |  |
|--------------------------------|--|--|
| <b>Lee Femtosecond Spatula</b> |  |  |
|--------------------------------|--|--|

The Lee spatula is a femtosecond cataract instrument. Flattened tip design offers benefits of opening both sideport and main incisions. A short handle allows for easy maneuvering under modern surgical abberometers. Angled shaft. Round handle.

AH4620

Lee Femtosecond Spatula



|  |  |  |
|--|--|--|
| <b>Slade Femtosecond Laser Spatula</b> |  |  |
|--|--|--|

Vaulted shaft, 22.0mm from bend to tip, flattened tip for opening the main and sideport incisions. Round handle. Overall length: 115mm.

AH4600

Slade Femtosecond Spatula



|                        |  |  |
|------------------------|--|--|
| <b>Suarez Spreader</b> |  |  |
|------------------------|--|--|

Straight shaft, angled blade tip, 1mm x 2mm blade. Round handle. Overall length: 118mm.

AH8150

Suarez Spreader



**IRIS SPATULAS**

| Item # | Description | Image |
|--------|-------------|-------|
|--------|-------------|-------|

**Barraquer Iris Spatula**

Angled shaft, 15mm from bend to tip, 0.5mm cylindrical smooth tip. Round handle. Overall length: 122mm.

AH5110 Barraquer Iris Spatula



**Culler Iris Spatula**

Curved shaft, 1mm wide x 28mm long spatula blade. Flat handle. Overall length: 127mm.

AH5170 Culler Iris Spatula



**Iris Spatula**

Slightly curved shafts with various size malleable blade tips.

AH5220 1mm Iris Spatula  
1mm wide x 30mm long tip. Flat handle. Overall length: 130mm.



AH5230 2mm Iris Spatula  
2mm wide x 33mm long tip. Round handle. Overall length: 136mm.



**LASIK SPATULAS**

| Item # | Description | Image |
|--------|-------------|-------|
|--------|-------------|-------|

**Intralase Flap Lifter and Retreatment Spatula**

Double-ended, angled shaft, 1.5mm from bend to tip, slightly pointed tip, spatula tip, Z-shaped tip, 12mm wide cylindrical spatula, slightly pointed tip. Round handle. Overall length: 106mm.

AH5275 Intralase Flap Lifter and Retreatment Spatula





## LASIK SPATULAS

| Item # | Description | Image |
|--------|-------------|-------|
|--------|-------------|-------|

|                                     |  |  |
|-------------------------------------|--|--|
| <b>Katzen LASIK Flap "Unzipper"</b> |  |  |
|-------------------------------------|--|--|

|  |  |  |
|--|--|--|
| Double-ended, straight shafts, modified sinskey hook, bi-convex spatula, beveled notches. Round handle. Overall length: 133mm. |  |  |
|--|--|--|

|        |                                   |  |
|--------|-----------------------------------|--|
| AH1000 | <a href="#">Katzen LASIK Flap</a> |  |
|--------|-----------------------------------|--|



## PHACO SPATULAS

| Item # | Description | Image |
|--------|-------------|-------|
|--------|-------------|-------|

|                               |  |  |
|-------------------------------|--|--|
| <b>Gimbel Nucleus Spatula</b> |  |  |
|-------------------------------|--|--|

|   |  |  |
|---|--|--|
| Angled 30-degree shaft, 9mm from bend to tip, 0.25mm diameter, smooth. Round handle. Overall length: 121mm. |  |  |
|---|--|--|

|        |  |  |
|--------|--|--|
| AH5190 | <a href="#">Gimbel Nucleus Spatula</a> |  |
|--------|--|--|



|                           |  |  |
|---------------------------|--|--|
| <b>Jaffe Lens Spatula</b> |  |  |
|---------------------------|--|--|

|  |  |  |
|--|--|--|
| Angled shaft, 10mm from bend to tip, 0.5mm wide, flat spatula. Flat handle. Overall length: 114mm. |  |  |
|--|--|--|

|        |                                    |  |
|--------|------------------------------------|--|
| AH5240 | <a href="#">Jaffe Lens Spatula</a> |  |
|--------|------------------------------------|--|



|                        |  |  |
|------------------------|--|--|
| <b>Johnson Spatula</b> |  |  |
|------------------------|--|--|

|  |  |  |
|--|--|--|
| Angled shaft, 10mm from bend to tip, 0.25mm wide blunt blade tip. Round handle. Overall length: 105mm. |  |  |
|--|--|--|

|        |                                 |  |
|--------|---------------------------------|--|
| AH5500 | <a href="#">Johnson Spatula</a> |  |
|--------|---------------------------------|--|











|   |  |  |
|---|--|--|
| <b>Knolle Lens Nucleus Spatula and Anterior Chamber Gauge</b> |  |  |
|---|--|--|

|  |  |  |
|--|--|--|
| Curved shaft, flat spatula blade, 30mm long blade, marks at 5mm, 6mm, and 7mm from tip. Round handle. Overall length: 126mm. |  |  |
|--|--|--|



|        |  |  |
|--------|--|--|
| AH5260 | <a href="#">Knolle Spatula and Chamber Gauge</a> |  |
|--------|--|--|



## PHACO SPATULAS

| Item #   | Description  | Image  |
|--|--|--|
| <b>Knolle Nucleus Spatula</b>  |  |  |
| Straight shaft, 0.5mm wide tip, malleable. Round handle. Overall length: 127mm.  |  |  |
| AH5265   | <a href="#">Knolle Nucleus Spatula</a>   |    |
| <b>Koch Nucleus Spatula</b>  |  |  |
| Curved shaft, 1mm wide, duckbill-shaped tip. Round handle. Overall length: 115mm.  |  |  |
| AH5256   | <a href="#">Koch Nucleus Spatula, Smooth</a><br>1mm wide tip.                  |    |
| AH5255   | <a href="#">Koch II-Nucleus Spatula, Notched</a><br>1mm wide tip with notches. |    |
| <b>Koch Phacoemulsification Spatula</b>  |  |  |
| Curved shaft, duckbill-shaped spatula tip, 0.8mm wide tip. Round handle. Overall length: 117mm.  |  |  |
| AH5267   | <a href="#">Koch Phacoemulsification Spatula</a>                               | <br>  |
| <b>Lieppman Nucleus Spatula</b>  |  |  |
| Angled shaft, forked tip, 0.5mm wide, blunt tip. Round handle. Overall length: 121mm.  |  |  |
| AH5270   | <a href="#">Lippman Nucleus Spatula</a>  |    |
| <b>Rowen Phaco Spatula</b>   |  |  |
| Double-ended, angled shafts, 9mm from bend to tip, phaco splitter, 60-degree interior cutting edge, blunt tip, 7mm from bend to tip, nucleus rotator, Y-shaped tip. Round handle. Overall length: 143mm. |  |  |
| AH5355   | <a href="#">Rowen Phaco Spatula</a>  | <br><br> |

REFRACTIVE SPATULAS

| Item #   | Description                             | Image  |
|--|---|--|
| <b>Kimura Platinum Spatula</b>   |   |  |
| Straight shaft, 34mm shaft, 4mm wide x 17.5mm flat platinum spatula. Flat handle. Overall length: 149mm.   |   |  |
| AH5250   | <a href="#">Kimura Platinum Spatula</a> |    |
| <b>Maloney PRK Spatula</b>   |   |  |
| Angled shaft, 5mm from bend to tip, 2mm wide spatula tip, semi-sharp. Round handle. Overall length: 120mm.   |   |  |
| AH5390   | <a href="#">Maloney PRK Spatula</a>     |    |
| <b>Paton Spatula and Spoon</b>   |   |  |
| Double-ended, angled shaft, 8mm from bend to tip, 1.5mm flat spatula, curved 6mm teardrop-shaped spoon with three long openings. Flat handle. Overall length: 140mm. |   |  |
| AH6140   | <a href="#">Paton Spatula and Spoon</a> |  |





RETINAL SPATULAS

| Item #   | Description  | Image  |
|--|--|--|
| <b>Maumenee-Barraquer Vitreous Sweep Spatula</b>   |  |  |
| Angled shaft, 11mm from bend to tip, spatula blade tip. Round handle. Overall length: 120mm. |  |  |
| AH5124   | <a href="#">Maumenee-Barraquer Spatula, Right</a><br>Right-hand use. |  |
| AH5125   | <a href="#">Maumenee-Barraquer Spatula, Left</a><br>Left-hand use.   |  |









# Speculums



## ADJUSTABLE SPECULUMS

| Item #  | Description                               | Image   |
|---|---|---|
| <b>Cook Eye Speculum</b>  |   |   |
| Pediatric size, 10mm solid round blades, 22mm blade spread, temporal approach, locking screw mechanism. Overall length: 57mm.                     |   |   |
| AL0340  | <a href="#">Cook Eye Speculum</a>         |     |
| <b>Kammann Eye Speculum</b>   |   |   |
| Adult size, 16mm closed K-wire fenestrated blades, self-locking mechanism, 27mm blade spread, temporal approach. Overall length: 70mm.            |   |   |
| AL0450  | <a href="#">Kammann Eye Speculum</a>      |   |
| <b>Lancaster Eye Speculum</b>   |   |   |
| Adult size, 15mm round solid blades, 35mm blade spread that is spring-controlled with locking mechanism, temporal approach. Overall length: 69mm. |   |   |
| AL0390  | <a href="#">Lancaster Eye Speculum</a>    |   |
| <b>Lester-Burch Eye Speculum</b>  |   |   |
| Adult size, 21mm round solid blades, 32mm blade spread, temporal approach, locking screw mechanism. Overall length: 82mm.                         |   |   |
| AL0400  | <a href="#">Lester-Burch Eye Speculum</a> |  |

## ADJUSTABLE SPECULUMS

| Item #  | Description  | Image  |
|---|--|--|
| <b>Lieberman Adjustable Speculum</b>  |  |  |
| Adult and pediatric size Lieberman adjustable speculums available in various blade sizes. The options of titanium or stainless steel with temporal, nasal, and reversible approaches are available. Lid tension is adjustable with thumb-screw control. |  |  |
| AL0521 S  | <b>Round, Solid Speculum</b><br>Pediatric size, 10mm round solid blades, temporal approach.<br>Overall length: 73mm. |    |
| AL0520 S  | <b>Round, Solid Speculum</b><br>Adult size, 14mm round solid blades, reversible approach. Overall length: 90mm.      |    |
| AL0520 N/K  | <b>K-Wire Speculum</b><br>Adult size, 14mm square open K-wire blades, nasal approach. Overall length: 83mm.          |   |
| AL0520 N/V  | <b>V-Wire Speculum</b><br>Adult size, 14mm open V-wire blades with no flare, nasal approach. Overall length: 83mm.   |  |
| AL0520 T/K  | <b>K-Wire Speculum</b><br>Adult size, 15mm open K-wire blades, temporal approach. Overall length: 90mm.              |  |
| AL0520 T/K TI   | <b>K-Wire Speculum</b><br>Adult size, titanium, 15mm open K-wire blades, temporal approach. Overall length: 90mm.    |  |
| AL0520 T/V  | <b>V-Wire Speculum</b><br>Adult size, 15mm open V-wire blades, temporal approach. Overall length: 90mm.              |  |
| AL0520 T/V TI   | <b>V-Wire Speculum</b><br>Adult size, titanium, 15mm V-wire blades, temporal approach. Overall length: 90mm.         |  |

ADJUSTABLE SPECULUMS

| Item #     | Description   | Image |
|------------|---|-------|
| AL0523 T/K | <p><b>K-Wire Speculum</b></p> <p>Designed for use during femtosecond cataract surgery. Adult size, 15mm open K-wire blades, temporal approach. Blades are covered in silicone tubing for patient comfort as well as for pushing back the conjunctiva. Overall length: 85mm.</p> |       |
| AL0523 T/V | <p><b>V-Wire Speculum</b></p> <p>Designed for use during femtosecond cataract surgery. Adult size, 15mm open V-wire blades, temporal approach. Blades are covered in silicone tubing for patient comfort as well as for pushing back the conjunctiva. Overall length: 85mm.</p> |       |
| AL0525     | <p><b>Round, Solid Speculum</b></p> <p>Adult size, 15mm round solid, thin blades, temporal approach. Overall length: 76mm.</p>  |       |

Schott Eye Speculum

Adult size, 16mm round closed wire blades, temporal approach, rotatable adjustment for control of blade elevation. Overall length: 140mm.

|        |                            |  |
|--------|----------------------------|--|
| AL0480 | <b>Schott Eye Speculum</b> |  |
|--------|----------------------------|--|

Williams Eye Speculum

Both adult and pediatric sizes are available in this Williams Eye Speculum. Various blade sizes and spread that are temporal in approach. Comes with a spring-controlled blade spread with screw-type locking mechanism.

|        |   |  |
|--------|---|--|
| AL0490 | <p><b>Adult Eye Speculum</b></p> <p>Adult size, 14mm closed K-wire blades, 52mm blade spread. Overall length: 86mm.</p>         |  |
| AL0500 | <p><b>Pediatric Eye Speculum</b></p> <p>Pediatric size, 11mm closed K-wire blades, 41mm blade spread. Overall length: 69mm.</p> |  |

**ASPIRATING SPECULUMS**

| Item # | Description | Image |
|--------|-------------|-------|
|--------|-------------|-------|

**Lieberman Aspirating Speculum**

Adult size, 12mm open K-wire blades, temporal approach, lid tension adjustable with thumb-screw control, supplied with silicone tubing and luer-lock adapter. Overall length: 82mm.

|        |   |  |
|--------|---|--|
| AL0530 | <a href="#">Lieberman Aspirating Speculum</a> |  |
|--------|---|--|



**Machat LASIK Speculum**

Aspirating and non-aspirating Machat LASIK speculums. Both are adult size with 17mm open V-wire blades, temporal approach, and have thumb-screw control for lid tension. Overall length: 76mm.

|        |  |  |
|--------|--|--|
| AL0533 | <a href="#">Machat Aspirating Speculum</a><br>Aspirating speculum. |  |
|--------|--|--|



|        |  |  |
|--------|--|--|
| AL0534 | <a href="#">Machat Adjustable Speculum</a><br>Non-aspirating speculum. |  |
|--------|--|--|

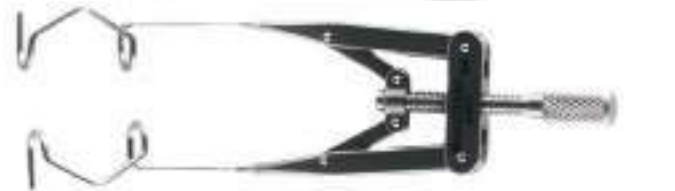

**WIRE SPECULUMS**

| Item # | Description | Image |
|--------|-------------|-------|
|--------|-------------|-------|

**Varley LASIK/Femtosecond Lid Speculum**

Adult size, 14mm open K-wire blades with modified bent shafts, 0.039 stainless steel wire, 30mm blade spread, temporal approach. Overall length: 60mm.

|        |   |  |
|--------|---|--|
| AL3190 | <a href="#">Varley LASIK/Femtosecond Lid Speculum</a> |  |
|--------|---|--|





## WIRE SPECULUMS

| Item # | Description | Image |
|--------|-------------|-------|
|--------|-------------|-------|

**Alfonso Eye Speculum**

Newborn size speculums available in both regular wire and heavy wire. 5mm closed K-wire blades with 27mm spread, temporal approach. Dull finish. Overall length: 45mm.

|        |                              |  |
|--------|------------------------------|--|
| AL0300 | <b>Wire Newborn Speculum</b> |  |
|--------|------------------------------|--|

Standard wire.

|        |                                    |  |
|--------|------------------------------------|--|
| AL0301 | <b>Heavy Wire Newborn Speculum</b> |  |
|--------|------------------------------------|--|

Heavy wire.

**Barraquer Lid Speculum**

A variety of Barraquer eye speculums in both adult and pediatric sizes. Solid, closed, and open blades that are both temporal and nasal in approach are available.





|        |                        |   |
|--------|------------------------|---|
| AL0190 | <b>K-Wire Speculum</b> |  |
|--------|------------------------|---|

Infant size, 4mm open K-wire blades, 15mm blade spread, temporal approach. Overall length: 31mm.





|        |                        |  |
|--------|------------------------|--|
| AL0141 | <b>K-Wire Speculum</b> |  |
|--------|------------------------|--|

Pediatric size, 8mm closed K-wire blades, 15mm blade spread, temporal approach. Overall length: 32mm.





## WIRE SPECULUMS

| Item #   | Description  | Image  |
|----------|--|--|
| AL0145 H | <p data-bbox="261 321 418 342"><b>K-Wire Speculum</b></p> <p data-bbox="261 354 781 401">Pediatric size, 9mm heavy closed K-wire blades, 11mm blade spread, temporal approach. Overall length: 30mm.</p>         |    |
| AL0100   | <p data-bbox="261 701 472 722"><b>Round, Solid Speculum</b></p> <p data-bbox="261 732 781 781">Pediatric size, 10mm round solid blades, 15mm blade spread, temporal approach. Overall length: 38mm.</p>          |   |
| AL0140   | <p data-bbox="261 1085 464 1106"><b>Round, Wire Speculum</b></p> <p data-bbox="261 1115 781 1165">Pediatric size, 11mm round closed wire blades, 15mm blade spread, temporal approach. Overall length: 38mm.</p> |  |
| AL0140S  | <p data-bbox="261 1470 418 1491"><b>K-Wire Speculum</b></p> <p data-bbox="261 1499 781 1549">Pediatric size, 11mm closed K-wire blades, square, 19mm blade spread, temporal approach. Overall length: 35mm.</p>  |  |

## WIRE SPECULUMS

| Item #   | Description  | Image  |
|----------|--|--|
| AL0121 S | <p data-bbox="261 321 418 342"><b>K-Wire Speculum</b></p> <p data-bbox="261 354 776 401">Adult size, 12mm closed K-wire blades, 18mm blade spread, temporal approach. Overall length: 32mm.</p>              |  <p>A wire speculum with two closed K-wire blades. The blades are positioned to provide a temporal approach. The overall length is 32mm.</p>       |
| AL0110   | <p data-bbox="261 701 472 722"><b>Round, Solid Speculum</b></p> <p data-bbox="261 735 776 781">Adult size, 14mm solid rounded blades, 18mm blade spread, temporal approach. Overall length: 41mm.</p>        |  <p>A solid speculum with two rounded blades. The blades are positioned to provide a temporal approach. The overall length is 41mm.</p>           |
| AL0120   | <p data-bbox="261 1087 467 1108"><b>Round, Wire Speculum</b></p> <p data-bbox="261 1121 743 1167">Adult size, 14mm round closed wire blades, 18mm blade spread, temporal approach. Overall length: 38mm.</p> |  <p>A wire speculum with two round closed wire blades. The blades are positioned to provide a temporal approach. The overall length is 38mm.</p> |
| AL0120 S | <p data-bbox="261 1470 418 1491"><b>K-Wire Speculum</b></p> <p data-bbox="261 1503 776 1549">Adult size, 14mm closed K-wire blades, 18mm blade spread, temporal approach. Overall length: 38mm.</p>          |  <p>A wire speculum with two closed K-wire blades. The blades are positioned to provide a temporal approach. The overall length is 38mm.</p>     |

## WIRE SPECULUMS

| Item # | Description  | Image  |
|--------|--|--|
| AL0126 | <p data-bbox="261 321 418 342"><b>K-Wire Speculum</b></p> <p data-bbox="261 354 776 401">Adult size, 14mm closed K-wire blades, 18mm blade spread, nasal approach. Overall length: 38mm.</p>                             |    |
| AL0130 | <p data-bbox="261 701 418 722"><b>K-Wire Speculum</b></p> <p data-bbox="261 732 753 781">Adult size, 14mm closed K-wire blades, heavy wire, 18mm blade spread, temporal approach. Overall length: 38mm.</p>              |   |
| AL0180 | <p data-bbox="261 1085 464 1106"><b>Round, Wire Speculum</b></p> <p data-bbox="261 1119 743 1165">Adult size, 14mm round closed wire blades, 18mm blade spread, temporal approach. Overall length 38mm.</p>              |  |
| AL0143 | <p data-bbox="261 1467 472 1488"><b>Round, Solid Speculum</b></p> <p data-bbox="261 1501 786 1547">Pediatric size, 14mm solid round blades, 18mm blade spread, temporal approach. Dull finish. Overall length: 41mm.</p> |  |

WIRE SPECULUMS

| Item # | Description | Image |
|--------|-------------|-------|
|--------|-------------|-------|

**Floyd-Barraquer Eye Speculum**

Adult size, 14mm closed round wire blades with 6mm lifting wings, 18mm blade spread, temporal approach. Overall length: 40mm.

|        |  |   |
|--------|--|---|
| AL0133 | <a href="#">Floyd-Barraquer Eye Speculum</a> |  |
|--------|--|---|

**Kratz-Barraquer Eye Speculum**

Adult and pediatric sizes with open K-wire blades and temporal approach.

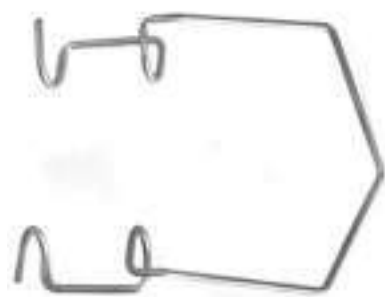
|        |  |   |
|--------|--|---|
| AL0160 | <p><a href="#">10mm Eye Speculum</a></p> <p>Pediatric size, 10mm blades, 19mm blade spread, temporal approach. Overall length: 35mm.</p> |  |
|--------|--|---|

|        |  |
|--------|--|
| AL0150 | <p><a href="#">14mm Eye Speculum</a></p> <p>Adult size, 14mm blades, 18mm blade spread, temporal approach. Overall length: 41mm.</p> |
|--------|--|

|        |   |
|--------|---|
| AL0165 | <p><a href="#">14mm Eye Speculum</a></p> <p>Adult size, 14mm heavy wire blades, 18mm blade spread, temporal approach. Overall length: 38mm.</p> |
|--------|---|

**Kratz-Nichamin Lid Speculum**

Adult size, 16mm open K-wire blades, temporal approach, wing tip twist that gives the surgeon better on-axis accessibility. Overall length: 45mm.

|        |   |  |
|--------|---|--|
| AL0151 | <a href="#">Kratz-Nichamin Lid Speculum</a> |  |
|--------|---|--|

## WIRE SPECULUMS

| Item # | Description | Image |
|--------|-------------|-------|
|--------|-------------|-------|

**Lehner Lid Speculum**

Adult size, 14mm open K-wire blades, heavy wire, 18mm blade spread, temporal approach, angled up 45 degrees. Overall length: 38mm.

|        |                                     |  |
|--------|-------------------------------------|--|
| AL0153 | <a href="#">Lehner Lid Speculum</a> |  |
|--------|-------------------------------------|--|

**Sauer Eye Speculum**

Infant size, 8mm round solid blades, 22mm blade spread, temporal approach. Overall length: 34mm.

|        |   |  |
|--------|---|--|
| AL0470 | <a href="#">Infant Sauer Eye Speculum</a> |  |
|--------|---|--|



**Slade Refractive Speculum**

Adult size, 0.035 stainless steel wire, 15mm round open wire blades with flared tips. Temporal approach. Overall length: 41mm.

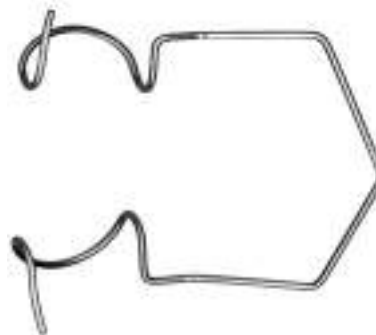
|        |  |  |
|--------|--|--|
| AL0175 | <a href="#">Slade Refractive Wire Speculum</a> |  |
|--------|--|--|



## WIRE SPECULUMS



| Item #   | Description   | Image   |
|--|---|---|
| <b>Temporal Approach Wire Speculum</b>   |   |   |
| Adult size wire speculums with temporal approach. K-wire or round blade options with 18mm blade spread in stainless steel. |   |   |
| AL0152   | <b>Round Temporal Speculum</b><br>14mm round closed blades. Overall length: 41mm. |   |
| AL0185   | <b>Square Temporal Speculum</b><br>14mm open K-wire blades. Overall length: 38mm. |  |

# Spoons

A decorative horizontal bar with a blue gradient, transitioning from a darker blue on the left to a lighter blue on the right, positioned below the title.



## EVISCERATION &amp; ENUCLEATION SPOONS



| Item #  | Description   | Image  |
|---|---|--|
| <b>Bunge Evisceration Spoon</b>   |   |  |
| Straight shaft, spoon blade, flat, smooth. Flat handle.   |   |  |
| AH6120  | <b>8mm Bunge Evisceration Spoon</b><br>8mm diameter spoon blade. Overall length: 136mm.   |  |
| AH6110  | <b>12mm Bunge Evisceration Spoon</b><br>12mm diameter spoon blade. Overall length: 140mm. |  |
| <b>Wells Enucleation Spoon</b>  |   |  |
| Straight shaft, curved spoon tip, 21mm wide spoon, 5mm wide x 10mm long notch in spoon. Flat handle. Overall length: 147mm. |   |  |
| AH6150  | <b>Wells Enucleation Spoon</b>  |  |

## LENS SPOONS







| Item #   | Description              | Image  |
|--|--------------------------|--|
| <b>Culler Lens Spoon</b>   |                          |  |
| Straight shaft, spoon-shaped tip, 5mm wide x 9mm long tip, solid middle. Flat handle. Overall length: 137mm. |                          |  |
| AH6130   | <b>Culler Lens Spoon</b> |  |

# Sterilization Trays

## METAL TRAYS

| Item #  | Description   | Image  |
|---|---|--|
| <b>Metal Microsurgical Instrument Sterilization Tray</b>  |   |  |
| Aluminum metal microsurgical instrument sterilization trays with hinged lids. Available in various sizes and comes as a single or double layer. |   |  |
| AT0242  | <p data-bbox="261 428 456 449"><b>Two-Layer Metal Tray</b></p> <p data-bbox="261 464 787 512">Two layers with pin mat and retainers. External size: 10.5"W x 10.5"L x 2.5"H. Internal size: 9.84"W x 10.2"L x 2.32"H.</p>   |    |
| AT0281  | <p data-bbox="261 814 456 835"><b>Two-Layer Metal Tray</b></p> <p data-bbox="261 850 787 919">Two layers with pin mat, retainers, short tray, and full-height accessory area. External size: 15"W x 10.5"L x 2.5"H. Internal size: 9.84"W x 14.60"L x 2.32"H.</p> |   |
| AT0241  | <p data-bbox="261 1192 477 1213"><b>Single-Layer Metal Tray</b></p> <p data-bbox="261 1228 787 1276">Single layer with pin mat and retainers. External size: 10.5"W x 10.5"L x 1.5"H. Internal size: 9.84"W x 10.2"L x 1.23"H.</p>                                |  |

## PLASTIC TRAYS

| Item #   | Description   | Image   |
|--|---|---|
| <b>Diamond Knife Tray</b>  |   |   |
| Plastic single-layer tray. Includes base, lid, and holder for up to three knives. Loose lid. Small size - 2.5"W x 6"L x 0.75"H.                            |   |   |
| AT0200   | <a href="#">Diamond Knife Tray</a>  |     |
| <b>Plastic Microsurgical Instrument Sterilization Tray</b>   |   |   |
| Various plastic microsurgical trays used for instrument sterilization with lid and silicone finger mats. Comes in a variety of different sizes. Loose lid. |   |   |
| AT0155   | <a href="#">Accutome Sterilization Tray, Small</a><br>Plastic single-layer tray. Includes base, lid, and silicone finger mat. Small size - 4"W x 7.5"L x 1.5"H.       |    |
| AT0210   | <a href="#">Accutome Sterilization Tray, Small</a><br>Plastic single-layer tray. Includes base, lid, and silicone finger mat. Small size - 2.5"W x 6"L x 0.75"H.      |   |
| AT0225   | <a href="#">Accutome Sterilization Tray, Small</a><br>Plastic single-layer tray. Includes base, lid, and silicone finger mat. Small size - 4"W x 7.5"L x 0.75"H.      |   |
| AT0190   | <a href="#">Accutome Sterilization Tray, Medium</a><br>Plastic single-layer tray. Includes base, lid, and silicone finger mat. Medium size - 6"W x 10"L x 0.75"H.     |  |
| AT0195   | <a href="#">Accutome Sterilization Tray, Medium</a><br>Plastic single-layer tray. Includes deep base, lid, and silicone finger mat. Medium size - 6"W x 10"L x 1.5"H. |   |

## PLASTIC TRAYS

| Item # | Description   | Image  |
|--------|---|--|
| AT0170 | <p><b>Accutome Sterilization Tray, Medium</b></p> <p>Plastic double-layer tray. Includes extra-deep base, insert tray, lid, and two silicone finger mats. Medium size - 6"W x 10"L x 1.5"H.</p> |  |

|        |  |  |
|--------|--|--|
| AT0160 | <p><b>Accutome Sterilization Tray, Large</b></p> <p>Plastic single-layer tray. Includes base, lid, and silicone finger mat. Large size - 10"W x 15"L x 0.75"H.</p> |  |
|--------|--|--|

## Plastic Phaco Instrument Sterilization Tray

Plastic Phaco single-layer instrument sterilization trays come with a base, lid, bars, and slots. Loose lid.

|        |   |   |
|--------|---|---|
| AT0600 | <p><b>1-Slot Phaco Tray</b></p> <p>Includes base, lid, 2 bars, and 1 slot. Medium size - 6"W x 10"L x 1.5"H.</p>  |  |
| AT0601 | <p><b>3-Slot Phaco Tray</b></p> <p>Includes base, lid, 2 bars, and 3 slots. Medium size - 6"W x 10"L x 1.5"H.</p> |   |

## Sterilization Tray Replacement Mat

Silicone finger mat for use in Accutome medium sterilization tray (AT0170). Light blue in color and has perforated bottom for draining. Medium size - 6"W x 10"L.

|                 |   |  |
|-----------------|---|--|
| AT0170 BTTM MAT | <b>Sterilization Tray Replacement Mat</b> |  |
|-----------------|---|--|

# Trephines & Punches

DISPOSABLE TREPHINES & PUNCHES

| Item # | Description | Image |
|--------|-------------|-------|
|--------|-------------|-------|

**Disposable Radial Vacuum Trephine**

Our sterile, single-use vacuum trephines consistently create accurate and uniform cuts by dividing the corneal chamber into 16 chambers, thus reducing corneal distortion. The ergonomic grip allows for easier control while making precision cuts on patient corneas. 16 radial marks allow for easy suture placement. Sold individually.

|          |   |
|----------|---|
| AB-67600 | <b>6.00mm Disposable Trephine</b><br>6.00mm diameter. |
| AB-67650 | <b>6.50mm Disposable Trephine</b><br>6.50mm diameter. |
| AB-67700 | <b>7.00mm Disposable Trephine</b><br>7.00mm diameter. |
| AB-67725 | <b>7.25mm Disposable Trephine</b><br>7.25mm diameter. |
| AB-67750 | <b>7.50mm Disposable Trephine</b><br>7.50mm diameter. |
| AB-67775 | <b>7.75mm Disposable Trephine</b><br>7.75mm diameter. |
| AB-67800 | <b>8.00mm Disposable Trephine</b><br>8.00mm diameter. |
| AB-67825 | <b>8.25mm Disposable Trephine</b><br>8.25mm diameter. |
| AB-67850 | <b>8.50mm Disposable Trephine</b><br>8.50mm diameter. |
| AB-67875 | <b>8.75mm Disposable Trephine</b><br>8.75mm diameter. |
| AB-67900 | <b>9.00mm Disposable Trephine</b><br>9.00mm diameter. |



**Vacuum Donor Punch**

Our sterile, single-use vacuum donor punches have an ultra-sharp cutting blade for making precision cuts of the donor tissue for corneal transplants. The punches feature four guide posts that ensure proper alignment. Sold individually.

|          |  |
|----------|--|
| AB-60600 | <b>6.00mm Disposable Punch</b><br>6.00mm diameter. |
| AB-60625 | <b>6.25mm Disposable Punch</b><br>6.25mm diameter. |
| AB-60650 | <b>6.50mm Disposable Punch</b><br>6.50mm diameter. |
| AB-60675 | <b>6.75mm Disposable Punch</b><br>6.75mm diameter. |
| AB-60700 | <b>7.00mm Disposable Punch</b><br>7.00mm diameter. |
| AB-60725 | <b>7.25mm Disposable Punch</b><br>7.25mm diameter. |
| AB-60750 | <b>7.50mm Disposable Punch</b><br>7.50mm diameter. |



**DISPOSABLE TREPHINES & PUNCHES**

| Item #   | Description  | Image   |
|----------|--|---|
| AB-60775 | <b>7.75mm Disposable Punch</b><br>7.75mm diameter. |  |
| AB-60785 | <b>7.85mm Disposable Punch</b><br>7.85mm diameter. |   |
| AB-60800 | <b>8.00mm Disposable Punch</b><br>8.00mm diameter. |   |
| AB-60825 | <b>8.25mm Disposable Punch</b><br>8.25mm diameter. |   |
| AB-60850 | <b>8.50mm Disposable Punch</b><br>8.50mm diameter. |   |
| AB-60875 | <b>8.75mm Disposable Punch</b><br>8.75mm diameter. |   |
| AB-60900 | <b>9.00mm Disposable Punch</b><br>9.00mm diameter. |   |
| AB-60925 | <b>9.25mm Disposable Punch</b><br>9.25mm diameter. |   |
| AB-60950 | <b>9.50mm Disposable Punch</b><br>9.50mm diameter. |   |

**REUSABLE TREPHINES & PUNCHES**

| Item #   | Description   | Image   |
|--|---|---|
| <b>Long Reusable Trephine Blade</b>  |   |   |
| Stainless steel, long, reusable trephine blades range in diameter from 2mm to 16mm. All blades are 15mm in length and are sold individually. |   |   |
| AM0570 20  | <b>2mm Long Trephine</b><br>2mm diameter blade tip.       |  |
| AM0570 25  | <b>2.5mm Long Trephine</b><br>2.5mm diameter blade tip.   |   |
| AM0570 30  | <b>3mm Long Trephine</b><br>3mm diameter blade tip.       |   |
| AM0570 40  | <b>4mm Long Trephine</b><br>4mm diameter blade tip.       |   |
| AM0570 45  | <b>4.5mm Long Trephine</b><br>4.5mm diameter blade tip.   |   |
| AM0570 50  | <b>5mm Long Trephine</b><br>5mm diameter blade tip.       |   |
| AM0570 60  | <b>6mm Long Trephine</b><br>6mm diameter blade tip.       |   |
| AM0570 65  | <b>6.5mm Long Trephine</b><br>6.5mm diameter blade tip.   |   |
| AM0570 67  | <b>6.75mm Long Trephine</b><br>6.75mm diameter blade tip. |   |



REUSABLE TREPHINES & PUNCHES

| Item #     | Description   | Image |
|------------|---|-------|
| AM0570 70  | <b>7mm Long Trephine</b><br>7mm diameter blade tip.       |       |
| AM0570 72  | <b>7.25mm Long Trephine</b><br>7.25mm diameter blade tip. |       |
| AM0570 75  | <b>7.5mm Long Trephine</b><br>7.5mm diameter blade tip.   |       |
| AM0570 77  | <b>7.75mm Long Trephine</b><br>7.75mm diameter blade tip. |       |
| AM0570 80  | <b>8mm Long Trephine</b><br>8mm diameter blade tip.       |       |
| AM0570 82  | <b>8.25mm Long Trephine</b><br>8.25mm diameter blade tip. |       |
| AM0570 85  | <b>8.5mm Long Trephine</b><br>8.5mm diameter blade tip.   |       |
| AM0570 87  | <b>8.75mm Long Trephine</b><br>8.75mm diameter blade tip. |       |
| AM0570 90  | <b>9mm Long Trephine</b><br>9mm diameter blade tip.       |       |
| AM0570 95  | <b>9.5mm Long Trephine</b><br>9.5mm diameter blade tip.   |       |
| AM0570 100 | <b>10mm Long Trephine</b><br>10mm diameter blade tip.     |       |
| AM0570 105 | <b>10.5mm Long Trephine</b><br>10.5mm diameter blade tip. |       |
| AM0570 110 | <b>11mm Long Trephine</b><br>11mm diameter blade tip.     |       |
| AM0570 115 | <b>11.5mm Long Trephine</b><br>11.5mm diameter blade tip. |       |
| AM0570 140 | <b>14mm Long Trephine</b><br>14mm diameter blade tip.     |       |
| AM0570 15  | <b>15mm Long Trephine</b><br>15mm diameter blade tip.     |       |
| AM0570 160 | <b>16mm Long Trephine</b><br>16mm diameter blade tip.     |       |

REUSABLE TREPHINES & PUNCHES

| Item #  | Description                                     | Image   |
|---|---|---|
| <b>Universal Trephine Blade Holder</b>  |   |   |
| Stainless steel, adjustable fingerlike tips that rest in the grooved disposable trephine blades, fits 3mm to 10mm short and long trephine blades. Round handle with screw-type adjustable spread. Overall length: 49mm. |   |   |
| AM0510  | <a href="#">Universal Trephine Blade Holder</a> |  |

# Instrument Covers



PROTECTORS & GUARDS

| Item # | Description | Image |
|--------|-------------|-------|
|--------|-------------|-------|

**Comply Instrument Protector**

3M Comply Instrument Protectors, protect sharp-pointed surgical instruments from damage and reduces possibility of pouch puncture during sterilization. It protects sharp surgical instruments from damage while holding them open for full sterilant contact. Dual indicators on the protector verify steam or EO processing. White instrument protector that measures 2 x 5 inches and is latex-free. Sold 100 per box.

|         |                            |   |
|---------|----------------------------|---|
| AXI3932 | White Instrument Protector |  |
|---------|----------------------------|---|



**Osteotome Instrument Tip Guard**

Designed to protect osteotome instrument edges from chipping during sterilization, storage, and handling. Covers can reduce monthly repair or replacement costs by meeting protection needs. Clear, non-vented osteotome instrument tip protector. Measures 6.4mm x 19mm. Nonsterile and latex-free. Sold 50 per bag.

|         |                        |  |
|---------|------------------------|--|
| AXI0806 | Clear Instrument Guard |  |
|---------|------------------------|--|







**Round Instrument Tip Guard**

Rounded tip guards designed to protect medical instruments from damage during sterilization, storage, and handling. Covers can reduce monthly repair or replacement costs by meeting protection needs. Blue-tinted, vented instrument tip protectors. Measures 38.1mm in length and fits 3mm to 4mm tips. Nonsterile and latex-free. Sold 70 per bag.





|         |                       |   |
|---------|-----------------------|---|
| AXII288 | Blue Instrument Guard |  |
|---------|-----------------------|---|



PROTECTORS & GUARDS



| Item #   | Description   | Image   |
|--|---|---|
| <b>Standard Instrument Tip Guard</b>   |   |   |
| Designed to protect medical instruments from damage during sterilization, storage, and handling. Covers can reduce monthly repair or replacement costs by meeting protection needs. Nonsterile and latex-free. Sold 100 per bag. |   |   |
| AXI0807  | <p data-bbox="261 449 475 470"><b>Clear Instrument Guard</b></p> <p data-bbox="261 483 779 525">Clear, vented instrument tip protectors. Measures 2.8mm x 19mm.</p>           |    |
| AXII208  | <p data-bbox="261 829 475 850"><b>Clear Instrument Guard</b></p> <p data-bbox="261 863 763 905">Clear, vented instrument tip protectors. Measures 5mm x 25mm.</p>             |   |
| AXI2025  | <p data-bbox="261 1209 482 1230"><b>Green Instrument Guard</b></p> <p data-bbox="261 1243 747 1285">Solid green, vented instrument tip protectors. Measures 2.8mm x 19mm.</p> |  |
| AXI3238  | <p data-bbox="261 1589 475 1610"><b>Clear Instrument Guard</b></p> <p data-bbox="261 1623 795 1665">Clear, nonvented instrument tip protectors. Measures 3.2mm x 25.4mm.</p>  |  |

PROTECTORS & GUARDS

| Item #  | Description   | Image   |
|---------|---|---|
| AXI5355 | <p><b>Clear Instrument Guard</b></p> <p>Clear, vented instrument tip protectors. Measures 2mm x 9mm x 25mm.</p>             |     |
| AXI5468 | <p><b>Assorted Instrument Guards</b></p> <p>Assorted colors, vented and solid instrument tip protectors. Various sizes.</p> |     |
| AXI3979 | <p><b>Orange Instrument Guard</b></p> <p>Orange-tinted, vented instrument tip protectors. Measures 2mm x 9mm x 25mm.</p>    |   |
| AXI5047 | <p><b>Orange Instrument Guard</b></p> <p>Orange-tinted, nonvented instrument tip protectors. Measures 2mm x 9mm x 25mm.</p> |  |

# Cleaning & Sterilizing

**DIAMOND KNIFE CLEANING SYSTEMS**

| Item #  | Description   | Image  |
|---|---|--|
| <b>Opti-Kleen</b>   |   |  |
| <p>Accutome recommends the Opti-Kleen blade cleaning system for the care and cleaning of diamond knives. This is an efficient and safe method for cleaning tissue and other debris from the surfaces of diamond knife blades prior to sterilization. The Opti-Kleen blade cleaning system comes with 12 individual disposable trays per dispenser box. A holding tray with cover can also be purchased to cradle the cleaning system trays. The Opti-Kleen blade cleaning system can be used throughout the day for both diamond knives and delicate instruments. Each new instrument should be cleaned in an area of the pad that has not already been used.</p> |   |  |
| AXI1396   | <p><b>Opti-Kleen Blade Cleaning System</b></p> <p>Each tray has three cleaning sections: a scrubbing section and two rinse sections. Sold 12 individual trays per box. Does not include plastic holder.</p> |    |
| AXI1397   | <p><b>Opti-Kleen Holding Tray</b></p> <p>Plastic holder for disposable cleaning system trays.</p>   |  |

**INDICATOR STRIPS**

| Item #  | Description                                  | Image  |
|---|--|--|
| <b>Biological Indicator Incubator</b>   |  |  |
| <p>3M Attest Incubator provides optimal incubation conditions for the accurate readout of 3M Attest biological indicators. Since the growth of each test organism is temperature dependent, it is critical that the appropriate Attest biological indicator be used with the correct Attest incubator. Biological indicator incubator, 14-vial (round), 56°C steam, 120 nominal voltage required, 90-132V acceptable.</p> |  |  |
| AXI4154   | <p><b>Biological Indicator Incubator</b></p> |  |



# PRODUCT NUMBER LOOKUP

|               |     |               |     |               |     |
|---------------|-----|---------------|-----|---------------|-----|
| AB-0550S..... | 262 | AB-2490.....  | 276 | AB-3855.....  | 282 |
| AB-1000.....  | 262 | AB-2801.....  | 280 | AB-3855S..... | 282 |
| AB-1000S..... | 262 | AB-2804.....  | 281 | AB-3856.....  | 282 |
| AB-1001.....  | 263 | AB-2805.....  | 280 | AB-3856S..... | 282 |
| AB-1052S..... | 263 | AB-2806.....  | 270 | AB-3857.....  | 284 |
| AB-1053S..... | 265 | AB-2807.....  | 270 | AB-4300.....  | 283 |
| AB-1401.....  | 263 | AB-2808.....  | 269 | AB-4302S..... | 283 |
| AB-1401S..... | 263 | AB-2808S..... | 269 | AB-4350S..... | 282 |
| AB-1402.....  | 266 | AB-2853.....  | 280 | AB-4351.....  | 283 |
| AB-1403.....  | 262 | AB-2854.....  | 269 | AB-4351S..... | 283 |
| AB-1404.....  | 263 | AB-2855.....  | 268 | AB-4352.....  | 274 |
| AB-1404S..... | 263 | AB-2856.....  | 271 | AB-4353.....  | 273 |
| AB-1405.....  | 265 | AB-2859.....  | 270 | AB-4355.....  | 273 |
| AB-1406.....  | 263 | AB-2860S..... | 279 | AB-4356.....  | 274 |
| AB-1406S..... | 264 | AB-2863.....  | 272 | AB-4357.....  | 274 |
| AB-1407.....  | 265 | AB-2865.....  | 271 | AB-4359.....  | 283 |
| AB-1407S..... | 266 | AB-2890.....  | 276 | AB-4359S..... | 283 |
| AB-1410.....  | 264 | AB-3305.....  | 280 | AB-4360.....  | 284 |
| AB-1410S..... | 264 | AB-3305S..... | 280 | AB-5351.....  | 283 |
| AB-1411.....  | 271 | AB-3353.....  | 281 | AB-8102.....  | 276 |
| AB-1412.....  | 272 | AB-3354S..... | 280 | AB-8109.....  | 275 |
| AB-1421.....  | 266 | AB-3355.....  | 281 | AB-8111.....  | 276 |
| AB-1452.....  | 264 | AB-3355S..... | 281 | AB-8112.....  | 275 |
| AB-1457.....  | 268 | AB-3356.....  | 280 | AB-8117.....  | 277 |
| AB-1459.....  | 264 | AB-3358S..... | 281 | AB-8123.....  | 277 |
| AB-1467.....  | 278 | AB-3361.....  | 268 | AB-8126.....  | 276 |
| AB-1468S..... | 264 | AB-3361S..... | 268 | AB-8127.....  | 277 |
| AB-1474.....  | 264 | AB-3362S..... | 270 | AB-8137.....  | 274 |
| AB-1475.....  | 265 | AB-3363S..... | 269 | AB-8138.....  | 277 |
| AB-1476.....  | 262 | AB-3364.....  | 268 | AB-8697G..... | 278 |
| AB-1478S..... | 262 | AB-3364S..... | 268 | AB-9105B..... | 164 |
| AB-1482.....  | 264 | AB-3365.....  | 267 | AB-9110.....  | 165 |
| AB-2000.....  | 265 | AB-3366.....  | 281 | AB-9110B..... | 164 |
| AB-2002.....  | 265 | AB-3370.....  | 272 | AB-9115.....  | 164 |
| AB-2002S..... | 265 | AB-3371.....  | 272 | AB-9120.....  | 165 |
| AB-2003.....  | 266 | AB-3372.....  | 272 | AB-9125P..... | 164 |
| AB-2003S..... | 266 | AB-3373.....  | 273 | AB-9130.....  | 165 |
| AB-2008.....  | 279 | AB-3374.....  | 273 | AB-9135.....  | 165 |
| AB-2008S..... | 279 | AB-3375.....  | 273 | AB-9155P..... | 164 |
| AB-2017.....  | 271 | AB-3376.....  | 272 | AB-9160P..... | 164 |
| AB-2023.....  | 278 | AB-3377.....  | 272 | AB-9170P..... | 164 |
| AB-2023S..... | 278 | AB-3378.....  | 273 | AB-9175P..... | 164 |
| AB-2028.....  | 266 | AB-3379S..... | 269 | AB-60600..... | 256 |
| AB-2054.....  | 266 | AB-3380.....  | 273 | AB-60625..... | 256 |
| AB-2056.....  | 267 | AB-3381S..... | 270 | AB-60650..... | 256 |
| AB-2058.....  | 267 | AB-3382.....  | 269 | AB-60675..... | 256 |
| AB-2062S..... | 279 | AB-3382S..... | 269 | AB-60700..... | 256 |
| AB-2063.....  | 279 | AB-3383S..... | 271 | AB-60725..... | 256 |
| AB-2068S..... | 279 | AB-3386.....  | 270 | AB-60750..... | 256 |
| AB-2090.....  | 275 | AB-3391.....  | 277 | AB-60775..... | 257 |
| AB-2091.....  | 276 | AB-3801.....  | 282 | AB-60785..... | 257 |
| AB-2092.....  | 276 | AB-3801S..... | 282 | AB-60800..... | 257 |
| AB-2455S..... | 267 | AB-3850S..... | 281 | AB-60825..... | 257 |
| AB-2457S..... | 267 | AB-3851.....  | 283 | AB-60850..... | 257 |
| AB-2461.....  | 267 | AB-3853S..... | 270 | AB-60875..... | 257 |
| AB-2461S..... | 267 | AB-3854.....  | 271 | AB-60900..... | 257 |
| AB-2463.....  | 268 | AB-3854S..... | 271 | AB-60925..... | 257 |

# PRODUCT NUMBER LOOKUP

|                   |     |                   |    |                 |    |
|-------------------|-----|-------------------|----|-----------------|----|
| AB-60950.....     | 257 | AB-AST15G .....   | 15 | AC0231 27 ..... | 80 |
| AB-67600.....     | 256 | AB-AST22 .....    | 13 | AC0320 5 .....  | 77 |
| AB-67650.....     | 256 | AB-AST22G .....   | 15 | AC0320 7 .....  | 77 |
| AB-67700.....     | 256 | AB-AST30 .....    | 13 | AC0320 8 .....  | 77 |
| AB-67725.....     | 256 | AB-AST45 .....    | 13 | AC0320 10 ..... | 77 |
| AB-67750.....     | 256 | AB-AVR10.....     | 13 | AC0350 .....    | 86 |
| AB-67775.....     | 256 | AB-AVR10AG.....   | 15 | AC0390 .....    | 84 |
| AB-67800.....     | 256 | AB-AVR10S.....    | 13 | AC0400 .....    | 85 |
| AB-67825.....     | 256 | AB-AVR12.....     | 13 | AC0457 .....    | 82 |
| AB-67850.....     | 256 | AB-AVR19.....     | 13 | AC0458 .....    | 83 |
| AB-67875.....     | 256 | AB-AVR19A.....    | 13 | AC0459 .....    | 82 |
| AB-67900.....     | 256 | AB-AVR19AG.....   | 15 | AC0460 .....    | 81 |
| AB-ACD26.....     | 14  | AB-AVR19G.....    | 15 | AC0460 23 ..... | 81 |
| AB-ACS20 .....    | 14  | AB-AVR20.....     | 13 | AC0461 .....    | 82 |
| AB-ACU26.....     | 14  | AB-AVR20A.....    | 13 | AC0462 .....    | 82 |
| AB-ACU26G.....    | 16  | AB-AVR20AG.....   | 16 | AC0463 .....    | 82 |
| AB-ALRI500G ..... | 16  | AB-AVR20G.....    | 15 | AC0465 .....    | 81 |
| AB-ALRI550G ..... | 16  | AB-AVR21AG.....   | 16 | AC0466 .....    | 83 |
| AB-ALRI600G ..... | 16  | AB-AVR21G.....    | 16 | AC0467 .....    | 82 |
| AB-ARS32 .....    | 14  | AB-AVR23A.....    | 13 | AC0469 .....    | 82 |
| AB-ARS35 .....    | 14  | AB-AVR23AG.....   | 16 | AC0473 .....    | 83 |
| AB-ARS41 .....    | 14  | AB-AVR23G.....    | 16 | AC0475 .....    | 83 |
| AB-ARS52 .....    | 14  | AB-AVR25.....     | 13 | AC0476 .....    | 83 |
| AB-ASL10.....     | 12  | AB-AVR25AG.....   | 16 | AC0478 .....    | 83 |
| AB-ASL12.....     | 12  | AB-AVR25G.....    | 16 | AC0485 .....    | 82 |
| AB-ASL18.....     | 12  | AC0105 .....      | 76 | AC0560 .....    | 86 |
| AB-ASL18DB.....   | 12  | AC0110 .....      | 76 | AC0560 27 ..... | 87 |
| AB-ASL20.....     | 12  | AC0120 .....      | 77 | AC0561 .....    | 87 |
| AB-ASL22.....     | 12  | AC0121 .....      | 77 | AC0565 .....    | 87 |
| AB-ASL22DB.....   | 12  | AC0122 .....      | 76 | AC0566 .....    | 87 |
| AB-ASL22G.....    | 15  | AC0125 .....      | 76 | AC0567 .....    | 87 |
| AB-ASL23.....     | 12  | AC0130 .....      | 77 | AC0570 .....    | 86 |
| AB-ASL24.....     | 12  | AC0131 .....      | 77 | AC0580 .....    | 87 |
| AB-ASL24DB.....   | 12  | AC0140 .....      | 77 | AC0582 .....    | 87 |
| AB-ASL24DBG.....  | 15  | AC0141 .....      | 77 | AC0583 .....    | 87 |
| AB-ASL24G.....    | 15  | AC0145 .....      | 76 | AC0584 .....    | 86 |
| AB-ASL25.....     | 12  | AC0160 .....      | 84 | AC0590 .....    | 86 |
| AB-ASL25DB.....   | 12  | AC0190 19.....    | 76 | AC0620 .....    | 78 |
| AB-ASL25G.....    | 15  | AC0190 20.....    | 76 | AC0630 .....    | 78 |
| AB-ASL26.....     | 12  | AC0190 23.....    | 76 | AC0640 .....    | 78 |
| AB-ASL26DB.....   | 12  | AC0190 25.....    | 76 | AC0665 .....    | 84 |
| AB-ASL26G.....    | 15  | AC0190 27.....    | 76 | AC0666 .....    | 84 |
| AB-ASL27.....     | 12  | AC0200 .....      | 87 | AC0675 .....    | 84 |
| AB-ASL27DB.....   | 12  | AC0201 .....      | 87 | AC0740 .....    | 78 |
| AB-ASL27G.....    | 15  | AC0220 .....      | 80 | AC0750 .....    | 78 |
| AB-ASL28.....     | 12  | AC0230 A .....    | 80 | AC0760 .....    | 78 |
| AB-ASL28DB.....   | 12  | AC0230 18.....    | 79 | AC0800 .....    | 79 |
| AB-ASL28G.....    | 15  | AC0230 19.....    | 79 | AC0810 .....    | 79 |
| AB-ASL30.....     | 13  | AC0230 19 CS..... | 81 | AC0820 .....    | 79 |
| AB-ASL30DB.....   | 13  | AC0230 21 .....   | 79 | AC1030 13 ..... | 84 |
| AB-ASL30G.....    | 15  | AC0230 23 .....   | 80 | AC1030 21 ..... | 84 |
| AB-ASL32.....     | 13  | AC0230 23 CS..... | 81 | AC1030 25 ..... | 84 |
| AB-ASL32DB.....   | 13  | AC0230 25 .....   | 80 | AC1040 .....    | 88 |
| AB-ASL32G.....    | 15  | AC0230 25 CS..... | 81 | AC1300 .....    | 85 |
| AB-ASL35.....     | 13  | AC0230 26 .....   | 80 | AC1301 .....    | 85 |
| AB-ASL285.....    | 12  | AC0230 27 .....   | 80 | AC1305 .....    | 85 |
| AB-AST15 .....    | 13  | AC0231 19.....    | 79 | AC2110 .....    | 86 |

# PRODUCT NUMBER LOOKUP

|                |     |                |     |               |     |
|----------------|-----|----------------|-----|---------------|-----|
| AC2120.....    | 86  | AF0160.....    | 36  | AF1185.....   | 138 |
| AC2130.....    | 86  | AF0162.....    | 36  | AF1190.....   | 138 |
| AC2140.....    | 86  | AF0210.....    | 130 | AF1240.....   | 138 |
| AC2155.....    | 85  | AF0215.....    | 130 | AF1250.....   | 138 |
| AC2262.....    | 84  | AF0230.....    | 130 | AF1270.....   | 138 |
| AC2263.....    | 84  | AF0250.....    | 130 | AF1280.....   | 139 |
| AC4174.....    | 81  | AF0285T.....   | 139 | AF1290.....   | 139 |
| AC4175.....    | 81  | AF0286.....    | 139 | AF1290TI..... | 139 |
| AC5120.....    | 167 | AF0288.....    | 131 | AF1295.....   | 139 |
| AC5120T.....   | 168 | AF0290.....    | 132 | AF1400.....   | 155 |
| AC5140.....    | 168 | AF0290 A.....  | 132 | AF1403.....   | 155 |
| AC5140T.....   | 168 | AF0290K.....   | 132 | AF2100.....   | 140 |
| AC5141T.....   | 168 | AF0290K T..... | 133 | AF2105.....   | 155 |
| AC5150.....    | 168 | AF0290L.....   | 134 | AF2110.....   | 140 |
| AC5150T.....   | 169 | AF0290M.....   | 134 | AF2120.....   | 140 |
| AC5151.....    | 169 | AF0290M T..... | 134 | AF2130.....   | 140 |
| AC5151T.....   | 169 | AF0290TI.....  | 133 | AF2140.....   | 140 |
| AC5160.....    | 169 | AF0291.....    | 140 | AF2150.....   | 141 |
| AC5160T.....   | 169 | AF0292.....    | 131 | AF2320.....   | 141 |
| AC5170.....    | 170 | AF0295.....    | 131 | AF2360.....   | 142 |
| AC5170T.....   | 170 | AF0299.....    | 133 | AF2370.....   | 142 |
| AC5180.....    | 170 | AF0300.....    | 133 | AF2380.....   | 142 |
| AC5180T.....   | 170 | AF0300 C.....  | 131 | AF2395.....   | 142 |
| AC5215.....    | 168 | AF0300TI.....  | 133 | AF2400.....   | 142 |
| AC5220.....    | 169 | AF0310.....    | 133 | AF2405.....   | 145 |
| AC5220T.....   | 170 | AF0310TI.....  | 133 | AF2440.....   | 142 |
| AC5235.....    | 168 | AF0340.....    | 132 | AF2450.....   | 143 |
| AC5235T.....   | 168 | AF0350.....    | 133 | AF2451.....   | 143 |
| AC5245.....    | 169 | AF0355.....    | 132 | AF2510.....   | 154 |
| AC5245T.....   | 169 | AF0365T.....   | 131 | AF2520.....   | 154 |
| AC5400.....    | 88  | AF0400.....    | 134 | AF2540.....   | 143 |
| AC6540.....    | 85  | AF0410.....    | 134 | AF3145TI..... | 150 |
| AC7000.....    | 166 | AF0411.....    | 134 | AF3150.....   | 145 |
| AC7010.....    | 166 | AF0430.....    | 134 | AF3175.....   | 150 |
| AC7030.....    | 165 | AF0440.....    | 135 | AF3177TI..... | 151 |
| AC7032.....    | 165 | AF0450.....    | 135 | AF3225.....   | 146 |
| AC7040.....    | 166 | AF0460.....    | 135 | AF3230.....   | 146 |
| AC7050.....    | 166 | AF0470.....    | 135 | AF3240.....   | 146 |
| AC7100.....    | 165 | AF0520.....    | 135 | AF3305.....   | 145 |
| AC7110.....    | 166 | AF0530.....    | 132 | AF3345.....   | 146 |
| AC7120.....    | 167 | AF0600.....    | 143 | AF3355TI..... | 149 |
| AC7130.....    | 166 | AF0700.....    | 144 | AF3360.....   | 147 |
| AC7430.....    | 166 | AF0750.....    | 144 | AF3370.....   | 147 |
| AC7431.....    | 166 | AF0800.....    | 136 | AF3390.....   | 146 |
| AC7450.....    | 167 | AF0801.....    | 136 | AF3480.....   | 145 |
| AC7451.....    | 167 | AF0810.....    | 136 | AF3540.....   | 161 |
| AC7530.....    | 167 | AF0820.....    | 136 | AF3600.....   | 149 |
| AC8000.....    | 167 | AF0830.....    | 136 | AF3700.....   | 147 |
| AF0100.....    | 37  | AF0840.....    | 137 | AF3705.....   | 147 |
| AF0120.....    | 37  | AF1110.....    | 137 | AF3710.....   | 147 |
| AF0120 IN..... | 37  | AF1110T.....   | 137 | AF3720.....   | 147 |
| AF0125.....    | 36  | AF1115.....    | 141 | AF3730.....   | 148 |
| AF0127.....    | 36  | AF1150.....    | 137 | AF3740.....   | 148 |
| AF0130.....    | 37  | AF1160.....    | 137 | AF3750.....   | 148 |
| AF0130 I.....  | 37  | AF1170.....    | 137 | AF3760.....   | 148 |
| AF0140.....    | 37  | AF1180.....    | 139 | AF3765.....   | 148 |
| AF0145 A.....  | 38  | AF1180TI.....  | 139 | AF3775.....   | 148 |

# PRODUCT NUMBER LOOKUP

|               |     |               |     |               |     |
|---------------|-----|---------------|-----|---------------|-----|
| AF4100.....   | 143 | AF6420TI..... | 159 | AH0620.....   | 120 |
| AF4110.....   | 143 | AF6421.....   | 159 | AH0630.....   | 117 |
| AF4120.....   | 144 | AF6424.....   | 159 | AH0630T.....  | 117 |
| AF4130.....   | 144 | AF6430.....   | 159 | AH0630TI..... | 117 |
| AF4310.....   | 149 | AF6450.....   | 159 | AH0640.....   | 117 |
| AF4320.....   | 149 | AF6455.....   | 156 | AH0650.....   | 118 |
| AF4400.....   | 149 | AF6470.....   | 160 | AH0660.....   | 118 |
| AF5100.....   | 151 | AF6530.....   | 160 | AH0670.....   | 118 |
| AF5110.....   | 151 | AF6580.....   | 157 | AH0675T.....  | 118 |
| AF5110TI..... | 151 | AF6700.....   | 161 | AH0680.....   | 100 |
| AF5140.....   | 152 | AF6710.....   | 161 | AH0690.....   | 101 |
| AF5150.....   | 152 | AF6720.....   | 161 | AH0695T.....  | 100 |
| AF5160.....   | 152 | AF6730.....   | 161 | AH0710.....   | 102 |
| AF5170.....   | 152 | AF6760.....   | 161 | AH0730.....   | 102 |
| AF5170TI..... | 152 | AF6770.....   | 162 | AH0740.....   | 103 |
| AF5180.....   | 152 | AF6780.....   | 162 | AH0750.....   | 119 |
| AF5180K.....  | 153 | AF6900.....   | 162 | AH0760.....   | 119 |
| AF5180TI..... | 153 | AF6910.....   | 162 | AH0770.....   | 119 |
| AF5190.....   | 153 | AF6920.....   | 162 | AH0780.....   | 119 |
| AF5200.....   | 152 | AF6930.....   | 161 | AH0790.....   | 119 |
| AF5200TI..... | 152 | AF6950.....   | 142 | AH0800.....   | 120 |
| AF5210.....   | 153 | AF7600.....   | 150 | AH0810.....   | 121 |
| AF5220.....   | 153 | AF7610.....   | 150 | AH0820.....   | 121 |
| AF5225.....   | 153 | AF7635.....   | 150 | AH0860.....   | 99  |
| AF5240.....   | 154 | AF7640TI..... | 150 | AH0870 C..... | 99  |
| AF5270.....   | 154 | AF8000.....   | 145 | AH0880.....   | 108 |
| AF5290.....   | 154 | AF9050TI..... | 149 | AH0890.....   | 108 |
| AF5300.....   | 151 | AF9075.....   | 144 | AH0905.....   | 114 |
| AF6100.....   | 155 | AH0130.....   | 90  | AH1000.....   | 234 |
| AF6101.....   | 155 | AH0140.....   | 94  | AH1100.....   | 114 |
| AF6110.....   | 155 | AH0150.....   | 94  | AH1110.....   | 104 |
| AF6130.....   | 156 | AH0160.....   | 94  | AH1130.....   | 116 |
| AF6135.....   | 155 | AH0170.....   | 94  | AH1140.....   | 99  |
| AF6136.....   | 155 | AH0180.....   | 94  | AH1150.....   | 103 |
| AF6137.....   | 155 | AH0190.....   | 94  | AH1155.....   | 103 |
| AF6140.....   | 156 | AH0200.....   | 94  | AH1160.....   | 103 |
| AF6178.....   | 141 | AH0210.....   | 94  | AH1165.....   | 103 |
| AF6300.....   | 156 | AH0220.....   | 90  | AH1170.....   | 104 |
| AF6300TI..... | 156 | AH0222.....   | 91  | AH1175.....   | 104 |
| AF6330.....   | 156 | AH0225.....   | 90  | AH1180.....   | 119 |
| AF6350.....   | 160 | AH0226.....   | 91  | AH1190.....   | 104 |
| AF6350TI..... | 160 | AH0228.....   | 90  | AH1190TI..... | 104 |
| AF6351.....   | 157 | AH0240.....   | 90  | AH1200.....   | 104 |
| AF6355.....   | 160 | AH0260.....   | 198 | AH1210.....   | 104 |
| AF6355T.....  | 160 | AH0300.....   | 199 | AH1510.....   | 98  |
| AF6360.....   | 157 | AH0305.....   | 81  | AH1520.....   | 98  |
| AF6370.....   | 157 | AH0510.....   | 127 | AH1530.....   | 99  |
| AF6380.....   | 157 | AH0520.....   | 128 | AH1530T.....  | 99  |
| AF6395.....   | 130 | AH0530.....   | 115 | AH1540.....   | 99  |
| AF6400.....   | 158 | AH0540.....   | 115 | AH1540T.....  | 99  |
| AF6400 S..... | 158 | AH0550.....   | 97  | AH1550.....   | 100 |
| AF6400TI..... | 158 | AH0560.....   | 97  | AH1560.....   | 101 |
| AF6404.....   | 158 | AH0580.....   | 115 | AH1570.....   | 101 |
| AF6410.....   | 158 | AH0590.....   | 120 | AH1580.....   | 96  |
| AF6410S.....  | 158 | AH0600.....   | 117 | AH1600.....   | 115 |
| AF6410TI..... | 158 | AH0605.....   | 115 | AH2100.....   | 114 |
| AF6420.....   | 159 | AH0610.....   | 120 | AH2110.....   | 114 |

# PRODUCT NUMBER LOOKUP

|               |     |               |     |              |     |
|---------------|-----|---------------|-----|--------------|-----|
| AH2120.....   | 115 | AH4182.....   | 109 | AH5255.....  | 235 |
| AH2130.....   | 116 | AH4184.....   | 110 | AH5256.....  | 235 |
| AH2135.....   | 102 | AH4184TI..... | 110 | AH5260.....  | 234 |
| AH2140.....   | 116 | AH4185T.....  | 110 | AH5265.....  | 235 |
| AH2150.....   | 116 | AH4190.....   | 103 | AH5267.....  | 235 |
| AH2160.....   | 116 | AH4195.....   | 108 | AH5270.....  | 235 |
| AH2190.....   | 118 | AH4200.....   | 104 | AH5275.....  | 233 |
| AH2210.....   | 122 | AH4205.....   | 106 | AH5290.....  | 204 |
| AH2230.....   | 118 | AH4205T.....  | 106 | AH5310.....  | 204 |
| AH2240.....   | 120 | AH4210.....   | 107 | AH5355.....  | 235 |
| AH2505.....   | 172 | AH4215.....   | 107 | AH5360.....  | 120 |
| AH2506.....   | 172 | AH4216.....   | 107 | AH5370.....  | 231 |
| AH2510.....   | 172 | AH4218.....   | 112 | AH5380.....  | 98  |
| AH2515.....   | 172 | AH4220.....   | 101 | AH5385.....  | 98  |
| AH2540.....   | 174 | AH4236.....   | 107 | AH5390.....  | 236 |
| AH2580.....   | 174 | AH4240.....   | 109 | AH5500.....  | 234 |
| AH2595.....   | 174 | AH4240TI..... | 109 | AH6110.....  | 250 |
| AH3110.....   | 182 | AH4242.....   | 109 | AH6120.....  | 250 |
| AH3130.....   | 182 | AH4242T.....  | 109 | AH6130.....  | 250 |
| AH3150.....   | 182 | AH4243.....   | 109 | AH6140.....  | 236 |
| AH3160.....   | 117 | AH4265.....   | 110 | AH6150.....  | 250 |
| AH3170.....   | 182 | AH4275.....   | 112 | AH6500.....  | 197 |
| AH3180.....   | 183 | AH4282.....   | 96  | AH6510.....  | 198 |
| AH3190.....   | 183 | AH4288.....   | 106 | AH6520.....  | 198 |
| AH3200.....   | 182 | AH4289.....   | 106 | AH6530.....  | 198 |
| AH3210.....   | 183 | AH4290.....   | 106 | AH6545.....  | 106 |
| AH3215.....   | 108 | AH4290T.....  | 106 | AH6610.....  | 232 |
| AH3220.....   | 183 | AH4295.....   | 106 | AH6950.....  | 119 |
| AH3230.....   | 183 | AH4300.....   | 101 | AH7100T..... | 105 |
| AH4100.....   | 96  | AH4345.....   | 110 | AH7101.....  | 105 |
| AH4100T.....  | 96  | AH4346.....   | 110 | AH7105T..... | 105 |
| AH4110.....   | 96  | AH4375.....   | 109 | AH7106T..... | 105 |
| AH4115.....   | 107 | AH4376.....   | 109 | AH7107T..... | 105 |
| AH4120.....   | 97  | AH4380.....   | 108 | AH7110.....  | 105 |
| AH4121.....   | 97  | AH4381.....   | 108 | AH7115.....  | 108 |
| AH4122.....   | 97  | AH4385T.....  | 109 | AH7120.....  | 114 |
| AH4125.....   | 97  | AH4400.....   | 110 | AH7125.....  | 100 |
| AH4126.....   | 112 | AH4450.....   | 96  | AH7130.....  | 107 |
| AH4126T.....  | 112 | AH4600.....   | 232 | AH7200.....  | 124 |
| AH4135.....   | 100 | AH4605.....   | 231 | AH7201.....  | 231 |
| AH4140.....   | 98  | AH4606.....   | 231 | AH7202.....  | 124 |
| AH4140TI..... | 98  | AH4620.....   | 232 | AH7210.....  | 91  |
| AH4145.....   | 108 | AH5100.....   | 230 | AH7220.....  | 124 |
| AH4160.....   | 102 | AH5110.....   | 233 | AH8150.....  | 232 |
| AH4161.....   | 102 | AH5120.....   | 230 | AK0001L..... | 32  |
| AH4170.....   | 111 | AH5124.....   | 236 | AK0002L..... | 32  |
| AH4170TI..... | 111 | AH5125.....   | 236 | AK0003L..... | 32  |
| AH4171T.....  | 110 | AH5130.....   | 230 | AK0009.....  | 33  |
| AH4172T.....  | 110 | AH5140.....   | 230 | AK0010.....  | 33  |
| AH4173.....   | 106 | AH5150.....   | 230 | AK0011L..... | 32  |
| AH4175.....   | 111 | AH5160.....   | 230 | AK0012L..... | 32  |
| AH4176.....   | 111 | AH5170.....   | 233 | AK0013L..... | 32  |
| AH4177.....   | 111 | AH5190.....   | 234 | AK0018L..... | 32  |
| AH4178.....   | 111 | AH5220.....   | 233 | AK0019L..... | 32  |
| AH4179.....   | 111 | AH5230.....   | 233 | AK0025.....  | 32  |
| AH4180.....   | 111 | AH5240.....   | 234 | AK0035.....  | 33  |
| AH4180T.....  | 111 | AH5250.....   | 236 | AK0038.....  | 32  |

# PRODUCT NUMBER LOOKUP

|                 |    |                   |    |                   |     |
|-----------------|----|-------------------|----|-------------------|-----|
| AK0041.....     | 33 | AK6160P500.....   | 28 | AK6175SPT500..... | 25  |
| AK0060.....     | 32 | AK6160P550.....   | 28 | AK6175SPT550..... | 25  |
| AK0061.....     | 32 | AK6160P600.....   | 28 | AK6175SPT600..... | 25  |
| AK5002.....     | 29 | AK6160PT200.....  | 26 | AK6180.....       | 23  |
| AK5003.....     | 29 | AK6160PT250.....  | 26 | AK6216.....       | 29  |
| AK5004.....     | 30 | AK6160PT300.....  | 26 | AK6230-2.....     | 23  |
| AK5005.....     | 29 | AK6160PT350.....  | 26 | AK6230-3.....     | 23  |
| AK5015.....     | 24 | AK6160PT400.....  | 26 | AK6235-2.....     | 29  |
| AK5017.....     | 30 | AK6160PT450.....  | 26 | AK6235-3.....     | 29  |
| AK6000-45.....  | 20 | AK6160PT500.....  | 26 | AK6410.....       | 19  |
| AK6001-45.....  | 20 | AK6160PT550.....  | 26 | AK6411.....       | 19  |
| AK6002-45.....  | 20 | AK6160PT600.....  | 26 | AK6412.....       | 19  |
| AK6003-45.....  | 20 | AK6160SPT200..... | 26 | AK6413.....       | 19  |
| AK6005-45.....  | 20 | AK6160SPT250..... | 26 | AK6415.....       | 19  |
| AK6007S.....    | 20 | AK6160SPT300..... | 26 | AK6419.....       | 19  |
| AK6009S.....    | 20 | AK6160SPT350..... | 26 | AK6424.....       | 19  |
| AK6010-45.....  | 21 | AK6160SPT400..... | 26 | AK6427.....       | 19  |
| AK6011-45.....  | 21 | AK6160SPT450..... | 26 | AK6449.....       | 19  |
| AK6012-45.....  | 21 | AK6160SPT500..... | 26 | AK6450.....       | 19  |
| AK6013-45.....  | 21 | AK6160SPT550..... | 26 | AK6451.....       | 19  |
| AK6015-45.....  | 21 | AK6160SPT600..... | 26 | AK6452.....       | 20  |
| AK6016-60.....  | 24 | AK6175.....       | 24 | AK6453.....       | 20  |
| AK6017S.....    | 21 | AK6175A.....      | 24 | AK6454.....       | 20  |
| AK6019S.....    | 21 | AK6175P200.....   | 27 | AK6455.....       | 20  |
| AK6021S.....    | 21 | AK6175P250.....   | 27 | AK6456.....       | 20  |
| AK6022S.....    | 21 | AK6175P300.....   | 27 | AK6458.....       | 20  |
| AK6023S.....    | 20 | AK6175P350.....   | 27 | AK6459.....       | 19  |
| AK6024S.....    | 21 | AK6175P400.....   | 27 | AK6461.....       | 19  |
| AK6026.....     | 24 | AK6175P450.....   | 27 | AK6465.....       | 19  |
| AK6030.....     | 23 | AK6175P500.....   | 27 | AL0100.....       | 243 |
| AK6040.....     | 22 | AK6175P550.....   | 27 | AL0110.....       | 244 |
| AK6041.....     | 22 | AK6175P600.....   | 27 | AL0120.....       | 244 |
| AK6044.....     | 22 | AK6175PC.....     | 27 | AL0120 S.....     | 244 |
| AK6047.....     | 21 | AK6175PT200.....  | 25 | AL0121 S.....     | 244 |
| AK6050.....     | 21 | AK6175PT250.....  | 25 | AL0126.....       | 245 |
| AK6051.....     | 22 | AK6175PT300.....  | 25 | AL0130.....       | 245 |
| AK6052.....     | 22 | AK6175PT350.....  | 25 | AL0133.....       | 246 |
| AK6053.....     | 22 | AK6175PT400.....  | 25 | AL0140.....       | 243 |
| AK6054.....     | 22 | AK6175PT450.....  | 25 | AL0140S.....      | 243 |
| AK6058.....     | 22 | AK6175PT500.....  | 25 | AL0141.....       | 242 |
| AK6059.....     | 22 | AK6175PT550.....  | 25 | AL0143.....       | 245 |
| AK6060.....     | 22 | AK6175PT600.....  | 25 | AL0145 H.....     | 243 |
| AK6064.....     | 22 | AK6175SP200.....  | 28 | AL0150.....       | 246 |
| AK6065.....     | 22 | AK6175SP250.....  | 28 | AL0151.....       | 246 |
| AK6067.....     | 22 | AK6175SP300.....  | 28 | AL0152.....       | 248 |
| AK6070-60.....  | 21 | AK6175SP350.....  | 28 | AL0153.....       | 247 |
| AK6072.....     | 21 | AK6175SP400.....  | 28 | AL0160.....       | 246 |
| AK6130.....     | 23 | AK6175SP450.....  | 28 | AL0165.....       | 246 |
| AK6150.....     | 24 | AK6175SP500.....  | 28 | AL0175.....       | 247 |
| AK6160.....     | 24 | AK6175SP550.....  | 28 | AL0180.....       | 245 |
| AK6160A.....    | 24 | AK6175SP600.....  | 29 | AL0185.....       | 248 |
| AK6160P200..... | 28 | AK6175SPT200..... | 25 | AL0190.....       | 242 |
| AK6160P250..... | 28 | AK6175SPT250..... | 25 | AL0300.....       | 242 |
| AK6160P300..... | 28 | AK6175SPT300..... | 25 | AL0301.....       | 242 |
| AK6160P350..... | 28 | AK6175SPT350..... | 25 | AL0340.....       | 238 |
| AK6160P400..... | 28 | AK6175SPT400..... | 25 | AL0390.....       | 238 |
| AK6160P450..... | 28 | AK6175SPT450..... | 25 | AL0400.....       | 238 |



# PRODUCT NUMBER LOOKUP

|                    |     |                  |     |               |     |
|--------------------|-----|------------------|-----|---------------|-----|
| AL0450.....        | 238 | AM0127.....      | 197 | AN0140.....   | 186 |
| AL0470.....        | 247 | AM0128.....      | 197 | AN0145.....   | 191 |
| AL0480.....        | 240 | AM0330.....      | 126 | AN0150.....   | 186 |
| AL0490.....        | 240 | AM0330 12.....   | 126 | AN0150TI..... | 186 |
| AL0500.....        | 240 | AM0330 13.....   | 126 | AN0160.....   | 186 |
| AL0520 N/K.....    | 239 | AM0330 14.....   | 126 | AN0160TI..... | 187 |
| AL0520 N/V.....    | 239 | AM0330 15.....   | 126 | AN0170.....   | 191 |
| AL0520 S.....      | 239 | AM0330 16.....   | 126 | AN0170T.....  | 187 |
| AL0520 T/K.....    | 239 | AM0330 17.....   | 126 | AN0180.....   | 190 |
| AL0520 T/K TI..... | 239 | AM0330 18.....   | 126 | AN0180TI..... | 190 |
| AL0520 T/V.....    | 239 | AM0330 19.....   | 126 | AN0190.....   | 190 |
| AL0520 T/V TI..... | 239 | AM0330 20.....   | 126 | AN0200.....   | 191 |
| AL0521 S.....      | 239 | AM0330 21.....   | 126 | AN0200TI..... | 191 |
| AL0523 T/K.....    | 240 | AM0330 22.....   | 126 | AN0210.....   | 186 |
| AL0523 T/V.....    | 240 | AM0330 23.....   | 126 | AN0210TI..... | 186 |
| AL0525.....        | 240 | AM0330 SET.....  | 127 | AN0220.....   | 190 |
| AL0530.....        | 241 | AM0410.....      | 202 | AN0230.....   | 188 |
| AL0533.....        | 241 | AM0410 1.00..... | 202 | AN0240.....   | 188 |
| AL0534.....        | 241 | AM0510.....      | 259 | AN0240TI..... | 188 |
| AL1100.....        | 199 | AM0560.....      | 162 | AN0250.....   | 188 |
| AL1110.....        | 199 | AM0570 15.....   | 258 | AN0260.....   | 191 |
| AL1120.....        | 199 | AM0570 20.....   | 257 | AN0270.....   | 187 |
| AL1130.....        | 199 | AM0570 25.....   | 257 | AN0280.....   | 187 |
| AL1280.....        | 178 | AM0570 30.....   | 257 | AN0290.....   | 187 |
| AL1320.....        | 176 | AM0570 40.....   | 257 | AN0300.....   | 187 |
| AL1330.....        | 176 | AM0570 45.....   | 257 | AN0300TI..... | 187 |
| AL1340.....        | 176 | AM0570 50.....   | 257 | AN0310.....   | 187 |
| AL1350.....        | 176 | AM0570 60.....   | 257 | AN0320.....   | 191 |
| AL1360.....        | 176 | AM0570 65.....   | 257 | AN0350TI..... | 191 |
| AL1370.....        | 177 | AM0570 67.....   | 257 | AN0400.....   | 188 |
| AL1375.....        | 176 | AM0570 70.....   | 258 | AN0410.....   | 188 |
| AL1380.....        | 177 | AM0570 72.....   | 258 | AN0430.....   | 188 |
| AL1390.....        | 178 | AM0570 75.....   | 258 | AN0440.....   | 188 |
| AL1400.....        | 177 | AM0570 77.....   | 258 | AN0460.....   | 189 |
| AL1410.....        | 178 | AM0570 80.....   | 258 | AN0470.....   | 192 |
| AL1420.....        | 177 | AM0570 82.....   | 258 | AN0480.....   | 189 |
| AL1430.....        | 178 | AM0570 85.....   | 258 | AN0490.....   | 192 |
| AL1440.....        | 178 | AM0570 87.....   | 258 | AN0500.....   | 189 |
| AL1450.....        | 178 | AM0570 90.....   | 258 | AN0510.....   | 186 |
| AL1460.....        | 178 | AM0570 95.....   | 258 | AN0520.....   | 192 |
| AL1530.....        | 177 | AM0570 100.....  | 258 | AN0525.....   | 192 |
| AL2110.....        | 121 | AM0570 105.....  | 258 | AN0540.....   | 189 |
| AL2120.....        | 121 | AM0570 110.....  | 258 | AN0560.....   | 192 |
| AL2130.....        | 121 | AM0570 115.....  | 258 | AN0600.....   | 189 |
| AL2140.....        | 121 | AM0570 140.....  | 258 | AN0610.....   | 193 |
| AL2150.....        | 121 | AM0570 160.....  | 258 | AN0620.....   | 189 |
| AL2155.....        | 121 | AM0830.....      | 36  | AN0625.....   | 192 |
| AL2180.....        | 122 | AM0831.....      | 36  | AN0700.....   | 193 |
| AL2210.....        | 122 | AM0940.....      | 343 | AR0120.....   | 41  |
| AL3190.....        | 241 | AM0970.....      | 343 | AR0121.....   | 41  |
| AL3300.....        | 122 | AM0975.....      | 343 | AR0121TI..... | 41  |
| AM0100.....        | 196 | AM7550.....      | 344 | AR0126.....   | 42  |
| AM0105.....        | 196 | AM9050.....      | 346 | AR0127.....   | 42  |
| AM0110.....        | 197 | AN0110.....      | 190 | AR0129.....   | 42  |
| AM0120.....        | 197 | AN0110TI.....    | 190 | AR0132.....   | 42  |
| AM0125.....        | 197 | AN0120.....      | 186 | AR0140.....   | 40  |
| AM0126.....        | 197 | AN0130.....      | 190 | AR0145.....   | 46  |

# PRODUCT NUMBER LOOKUP

|             |     |        |     |        |     |
|-------------|-----|--------|-----|--------|-----|
| AR0146      | 45  | AS0170 | 208 | AS4150 | 217 |
| AR0148      | 45  | AS0180 | 207 | AS4160 | 217 |
| AR0150      | 40  | AS0190 | 208 | AS4170 | 220 |
| AR0150TI    | 40  | AS0200 | 208 | AS4190 | 218 |
| AR0155      | 40  | AS0210 | 209 | AS4200 | 218 |
| AR0190      | 126 | AS0220 | 210 | AS4510 | 220 |
| AR0190TI    | 126 | AS0230 | 210 | AS4520 | 221 |
| AR0191      | 126 | AS0240 | 220 | AS4530 | 221 |
| AR0197      | 126 | AS0290 | 210 | AS4540 | 222 |
| AR0200      | 126 | AS0301 | 213 | AS4550 | 221 |
| AR0250 4.00 | 43  | AS0310 | 206 | AS4560 | 221 |
| AR0250 4.50 | 43  | AS0320 | 207 | AS4570 | 222 |
| AR0250 5.00 | 43  | AS0900 | 213 | AS4575 | 222 |
| AR0250 5.50 | 44  | AS0940 | 213 | AS4576 | 222 |
| AR0250 5.75 | 44  | AS1105 | 207 | AS4580 | 216 |
| AR0250 6.00 | 44  | AS1110 | 207 | AS4590 | 223 |
| AR0250 8.00 | 44  | AS1115 | 207 | AS4600 | 223 |
| AR0250 8.5  | 44  | AS1120 | 207 | AS4610 | 223 |
| AR0250 9.00 | 44  | AS1140 | 209 | AS4620 | 223 |
| AR0260      | 40  | AS1150 | 208 | AS5100 | 216 |
| AR0370 2.50 | 45  | AS1160 | 208 | AS5110 | 215 |
| AR0370 3.00 | 45  | AS1170 | 209 | AS5120 | 211 |
| AR0370 3.50 | 45  | AS1190 | 209 | AS5130 | 211 |
| AR0370 4.00 | 45  | AS1200 | 208 | AS5140 | 212 |
| AR0370 5.00 | 45  | AS1210 | 209 | AS5150 | 215 |
| AR0370 5.75 | 45  | AS1220 | 209 | AS5160 | 211 |
| AR0370 6.00 | 45  | AS1270 | 210 | AS5170 | 212 |
| AR0370 7.00 | 45  | AS1290 | 210 | AS5180 | 215 |
| AR0370 8.00 | 45  | AS2100 | 211 | AS5190 | 224 |
| AR0370 9.00 | 45  | AS2110 | 210 | AS5200 | 224 |
| AR0380      | 41  | AS2120 | 210 | AS5210 | 225 |
| AR0395      | 127 | AS2310 | 212 | AS5220 | 224 |
| AR0400 8    | 44  | AS2320 | 212 | AS5235 | 216 |
| AR0400 12   | 44  | AS2390 | 212 | AS5240 | 224 |
| AR0420      | 127 | AS3100 | 213 | AS5250 | 225 |
| AR0430      | 127 | AS3110 | 213 | AS5510 | 225 |
| AR0580      | 180 | AS3120 | 214 | AS5520 | 225 |
| AR0585      | 180 | AS3130 | 214 | AS5530 | 225 |
| AR0600      | 180 | AS3140 | 215 | AS5540 | 226 |
| AR0602      | 180 | AS3160 | 214 | AS5550 | 226 |
| AR0603      | 180 | AS3170 | 215 | AS5560 | 209 |
| AR0605      | 180 | AS3185 | 214 | AS5570 | 226 |
| AR0610      | 180 | AS3190 | 214 | AS5580 | 226 |
| AR0616      | 180 | AS3200 | 215 | AS5590 | 226 |
| AR4120      | 42  | AS3210 | 215 | AS5600 | 227 |
| AR4130      | 44  | AS3220 | 215 | AS5610 | 227 |
| AR4150      | 45  | AS3500 | 218 | AS5630 | 227 |
| AR8000      | 43  | AS3510 | 218 | AS5640 | 227 |
| AR8001      | 43  | AS3520 | 219 | AS5650 | 228 |
| AR8002      | 43  | AS3530 | 219 | AS5660 | 227 |
| AS0100      | 206 | AS3540 | 219 | AS5670 | 227 |
| AS0110      | 206 | AS3550 | 219 | AS5680 | 227 |
| AS0120      | 206 | AS4100 | 214 | AS5900 | 219 |
| AS0130      | 207 | AS4110 | 214 | AS5910 | 216 |
| AS0140      | 208 | AS4120 | 217 | AS6510 | 224 |
| AS0150      | 207 | AS4130 | 220 | AS6515 | 223 |
| AS0160      | 208 | AS4140 | 217 | AS6516 | 223 |



# PRODUCT NUMBER LOOKUP

|                      |     |              |     |              |     |
|----------------------|-----|--------------|-----|--------------|-----|
| AT0155.....          | 253 | AX10830..... | 308 | AX11750..... | 304 |
| AT0160.....          | 254 | AX10836..... | 324 | AX11774..... | 317 |
| AT0170.....          | 254 | AX10852..... | 323 | AX11795..... | 287 |
| AT0170 BTTM MAT..... | 254 | AX10853..... | 48  | AX11798..... | 317 |
| AT0190.....          | 253 | AX10870..... | 324 | AX11799..... | 317 |
| AT0195.....          | 253 | AX10900..... | 325 | AX11823..... | 291 |
| AT0200.....          | 253 | AX10905..... | 296 | AX11830..... | 319 |
| AT0210.....          | 253 | AX10914..... | 49  | AX11881..... | 318 |
| AT0225.....          | 253 | AX10918..... | 318 | AX11886..... | 307 |
| AT0241.....          | 252 | AX10919..... | 295 | AX11891..... | 60  |
| AT0242.....          | 252 | AX10923..... | 290 | AX11929..... | 306 |
| AT0281.....          | 252 | AX10943..... | 318 | AX11940..... | 301 |
| AT0600.....          | 254 | AX10957..... | 322 | AX11941..... | 301 |
| AT0601.....          | 254 | AX10981..... | 318 | AX11943..... | 293 |
| AX0208.....          | 288 | AX10982..... | 318 | AX11956..... | 52  |
| AX0951.....          | 307 | AX11011..... | 298 | AX11971..... | 294 |
| AX9810.....          | 297 | AX11013..... | 340 | AX11998..... | 315 |
| AX9811.....          | 297 | AX11032..... | 309 | AX12010..... | 311 |
| AX10055.....         | 299 | AX11033..... | 305 | AX12024..... | 324 |
| AX10085.....         | 315 | AX11038..... | 340 | AX12025..... | 331 |
| AX10086.....         | 315 | AX11042..... | 338 | AX12039..... | 293 |
| AX10087.....         | 315 | AX11069..... | 324 | AX12042..... | 307 |
| AX10088.....         | 315 | AX11186..... | 324 | AX12045..... | 48  |
| AX10089.....         | 315 | AX11208..... | 331 | AX12048..... | 323 |
| AX10092.....         | 316 | AX11213..... | 299 | AX12069..... | 335 |
| AX10095.....         | 300 | AX11240..... | 301 | AX12076..... | 286 |
| AX10126.....         | 295 | AX11250..... | 288 | AX12077..... | 287 |
| AX10146.....         | 302 | AX11261..... | 51  | AX12080..... | 52  |
| AX10155.....         | 342 | AX11265..... | 317 | AX13009..... | 317 |
| AX10170.....         | 294 | AX11288..... | 330 | AX13014..... | 66  |
| AX10193.....         | 313 | AX11290..... | 339 | AX13038..... | 338 |
| AX10235.....         | 317 | AX11347..... | 310 | AX13055..... | 298 |
| AX10240.....         | 290 | AX11348..... | 60  | AX13070..... | 196 |
| AX10319.....         | 294 | AX11369..... | 318 | AX13135..... | 324 |
| AX10339.....         | 294 | AX11396..... | 334 | AX13136..... | 324 |
| AX10388.....         | 289 | AX11397..... | 334 | AX13144..... | 278 |
| AX10400.....         | 337 | AX11419..... | 310 | AX13164..... | 303 |
| AX10413.....         | 341 | AX11432..... | 321 | AX13167..... | 335 |
| AX10414.....         | 48  | AX11455..... | 325 | AX13185..... | 306 |
| AX10432.....         | 304 | AX11463..... | 52  | AX13195..... | 298 |
| AX10438.....         | 298 | AX11506..... | 306 | AX13207..... | 302 |
| AX10439.....         | 298 | AX11593..... | 290 | AX13238..... | 331 |
| AX10445.....         | 311 | AX11626..... | 321 | AX13251..... | 291 |
| AX10494.....         | 311 | AX11627..... | 322 | AX13254..... | 51  |
| AX10502.....         | 292 | AX11630..... | 53  | AX13258..... | 336 |
| AX10508.....         | 303 | AX11638..... | 340 | AX13262..... | 292 |
| AX10516.....         | 316 | AX11640..... | 293 | AX13284..... | 286 |
| AX10525.....         | 309 | AX11642..... | 288 | AX13288..... | 340 |
| AX10545.....         | 342 | AX11646..... | 321 | AX13328..... | 287 |
| AX10560.....         | 308 | AX11649..... | 322 | AX13347..... | 339 |
| AX10591.....         | 303 | AX11681..... | 319 | AX13360..... | 297 |
| AX10649.....         | 68  | AX11683..... | 318 | AX13364..... | 287 |
| AX10683.....         | 325 | AX11684..... | 320 | AX13424..... | 308 |
| AX10735.....         | 288 | AX11688..... | 320 | AX13426..... | 293 |
| AX10761.....         | 59  | AX11696..... | 304 | AX13441..... | 307 |
| AX10806.....         | 330 | AX11715..... | 320 | AX13674..... | 305 |
| AX10807.....         | 331 | AX11737..... | 323 | AX13832..... | 337 |

# PRODUCT NUMBER LOOKUP

|              |     |              |    |              |    |
|--------------|-----|--------------|----|--------------|----|
| AX13843..... | 296 | AX14581..... | 48 | AX14655..... | 50 |
| AX13929..... | 196 | AX14582..... | 48 | AX14656..... | 50 |
| AX13930..... | 196 | AX14583..... | 49 | AX14657..... | 50 |
| AX13932..... | 330 | AX14584..... | 49 | AX14658..... | 50 |
| AX13975..... | 325 | AX14585..... | 49 | AX14659..... | 50 |
| AX13979..... | 332 | AX14586..... | 49 | AX14660..... | 50 |
| AX13981..... | 295 | AX14587..... | 49 | AX14661..... | 50 |
| AX13984..... | 339 | AX14588..... | 49 | AX14662..... | 50 |
| AX13986..... | 300 | AX14590..... | 49 | AX14663..... | 50 |
| AX14020..... | 313 | AX14591..... | 50 | AX14664..... | 50 |
| AX14029..... | 196 | AX14592..... | 49 | AX14665..... | 54 |
| AX14039..... | 274 | AX14593..... | 49 | AX14666..... | 54 |
| AX14040..... | 274 | AX14594..... | 50 | AX14667..... | 54 |
| AX14041..... | 275 | AX14595..... | 53 | AX14668..... | 54 |
| AX14042..... | 275 | AX14597..... | 53 | AX14669..... | 54 |
| AX14043..... | 275 | AX14601..... | 53 | AX14670..... | 54 |
| AX14045..... | 277 | AX14602..... | 53 | AX14671..... | 54 |
| AX14046..... | 277 | AX14603..... | 53 | AX14672..... | 54 |
| AX14051..... | 289 | AX14604..... | 53 | AX14673..... | 54 |
| AX14058..... | 337 | AX14605..... | 52 | AX14674..... | 54 |
| AX14092..... | 319 | AX14607..... | 52 | AX14675..... | 54 |
| AX14105..... | 306 | AX14611..... | 52 | AX14676..... | 54 |
| AX14112..... | 14  | AX14613..... | 53 | AX14677..... | 54 |
| AX14116..... | 312 | AX14614..... | 53 | AX14678..... | 54 |
| AX14137..... | 299 | AX14615..... | 52 | AX14679..... | 54 |
| AX14139..... | 314 | AX14617..... | 52 | AX14680..... | 55 |
| AX14154..... | 334 | AX14619..... | 52 | AX14681..... | 56 |
| AX14173..... | 342 | AX14621..... | 52 | AX14682..... | 56 |
| AX14179..... | 299 | AX14623..... | 52 | AX14683..... | 56 |
| AX14189..... | 298 | AX14624..... | 52 | AX14684..... | 56 |
| AX14191..... | 300 | AX14625..... | 51 | AX14685..... | 56 |
| AX14229..... | 341 | AX14627..... | 51 | AX14686..... | 56 |
| AX14249..... | 297 | AX14628..... | 51 | AX14687..... | 56 |
| AX14250..... | 294 | AX14629..... | 51 | AX14688..... | 56 |
| AX14262..... | 302 | AX14630..... | 51 | AX14689..... | 56 |
| AX14267..... | 336 | AX14631..... | 52 | AX14690..... | 56 |
| AX14271..... | 340 | AX14632..... | 52 | AX14691..... | 55 |
| AX14280..... | 300 | AX14633..... | 52 | AX14692..... | 55 |
| AX14287..... | 314 | AX14634..... | 52 | AX14693..... | 55 |
| AX14291..... | 338 | AX14635..... | 51 | AX14694..... | 55 |
| AX14343..... | 293 | AX14636..... | 51 | AX14695..... | 55 |
| AX14348..... | 301 | AX14637..... | 51 | AX14696..... | 55 |
| AX14349..... | 289 | AX14638..... | 51 | AX14697..... | 55 |
| AX14425..... | 302 | AX14639..... | 51 | AX14698..... | 55 |
| AX14457..... | 340 | AX14640..... | 51 | AX14699..... | 55 |
| AX14460..... | 310 | AX14641..... | 51 | AX14700..... | 56 |
| AX14475..... | 336 | AX14642..... | 51 | AX14701..... | 56 |
| AX14487..... | 341 | AX14643..... | 51 | AX14702..... | 56 |
| AX14488..... | 289 | AX14644..... | 51 | AX14703..... | 56 |
| AX14510..... | 275 | AX14645..... | 50 | AX14704..... | 56 |
| AX14533..... | 196 | AX14646..... | 50 | AX14705..... | 57 |
| AX14568..... | 48  | AX14647..... | 50 | AX14706..... | 57 |
| AX14571..... | 48  | AX14648..... | 50 | AX14707..... | 57 |
| AX14572..... | 48  | AX14651..... | 51 | AX14708..... | 57 |
| AX14576..... | 48  | AX14652..... | 51 | AX14710..... | 57 |
| AX14577..... | 48  | AX14653..... | 51 | AX14711..... | 58 |
| AX14580..... | 48  | AX14654..... | 51 | AX14713..... | 57 |

# PRODUCT NUMBER LOOKUP

|              |    |              |     |                     |     |
|--------------|----|--------------|-----|---------------------|-----|
| AX14714..... | 58 | AX14819..... | 69  | AX15161.....        | 301 |
| AX14715..... | 58 | AX14820..... | 69  | AX15167.....        | 294 |
| AX14719..... | 59 | AX14821..... | 70  | AX15181.....        | 339 |
| AX14720..... | 59 | AX14822..... | 70  | AX15190.....        | 301 |
| AX14721..... | 59 | AX14824..... | 70  | AX15194.....        | 286 |
| AX14722..... | 59 | AX14825..... | 70  | AX15227.....        | 75  |
| AX14723..... | 58 | AX14826..... | 70  | AX15229.....        | 326 |
| AX14724..... | 58 | AX14827..... | 71  | AX15230.....        | 327 |
| AX14725..... | 58 | AX14828..... | 71  | AX15245.....        | 338 |
| AX14726..... | 63 | AX14829..... | 72  | AX15249.....        | 300 |
| AX14727..... | 62 | AX14830..... | 71  | AX15314.....        | 291 |
| AX14728..... | 63 | AX14831..... | 72  | AX15324.....        | 299 |
| AX14730..... | 62 | AX14832..... | 71  | AX15325.....        | 299 |
| AX14731..... | 60 | AX14833..... | 71  | AX15329.....        | 296 |
| AX14732..... | 60 | AX14834..... | 72  | AX15346.....        | 312 |
| AX14735..... | 63 | AX14835..... | 71  | AX15355.....        | 332 |
| AX14736..... | 61 | AX14836..... | 72  | AX15372.....        | 293 |
| AX14737..... | 61 | AX14837..... | 71  | AX15390.....        | 295 |
| AX14739..... | 60 | AX14838..... | 72  | AX15402.....        | 328 |
| AX14742..... | 62 | AX14839..... | 72  | AX15429.....        | 315 |
| AX14743..... | 61 | AX14840..... | 72  | AX15430.....        | 315 |
| AX14745..... | 62 | AX14841..... | 72  | AX15435.....        | 296 |
| AX14749..... | 63 | AX14843..... | 70  | AX15461.....        | 337 |
| AX14751..... | 62 | AX14844..... | 73  | AX15468.....        | 332 |
| AX14752..... | 60 | AX14845..... | 73  | AX15487.....        | 339 |
| AX14753..... | 60 | AX14846..... | 73  | AX15490.....        | 292 |
| AX14754..... | 64 | AX14847..... | 73  | AX15553.....        | 315 |
| AX14755..... | 63 | AX14848..... | 73  | AX15555.....        | 298 |
| AX14756..... | 64 | AX14849..... | 73  | AX15581.....        | 75  |
| AX14757..... | 64 | AX14850..... | 73  | AX15590.....        | 313 |
| AX14758..... | 64 | AX14851..... | 74  | AX15630.....        | 75  |
| AX14759..... | 64 | AX14852..... | 74  | AX15635.....        | 70  |
| AX14760..... | 64 | AX14853..... | 74  | AX15636.....        | 70  |
| AX14763..... | 65 | AX14855..... | 74  | AX15643.....        | 315 |
| AX14764..... | 65 | AX14889..... | 323 | AX15644.....        | 315 |
| AX14765..... | 65 | AX14906..... | 292 | AX15672.....        | 337 |
| AX14766..... | 65 | AX14908..... | 305 | AX15689.....        | 335 |
| AX14767..... | 65 | AX14910..... | 326 | AX15723.....        | 312 |
| AX14772..... | 66 | AX14964..... | 320 | AX15736.....        | 340 |
| AX14773..... | 67 | AX14965..... | 321 | AX15752.....        | 341 |
| AX14775..... | 67 | AX14968..... | 319 | AX15809.....        | 342 |
| AX14776..... | 67 | AX14993..... | 336 | AX20001.....        | 75  |
| AX14777..... | 67 | AX14994..... | 309 | AX20001-BULK.....   | 75  |
| AX14778..... | 66 | AX15012..... | 326 | AX111637.....       | 48  |
| AX14780..... | 67 | AX15014..... | 295 | AX111642.....       | 48  |
| AX14781..... | 67 | AX15021..... | 323 | AX115027.....       | 48  |
| AX14784..... | 66 | AX15042..... | 312 | AX121273.....       | 53  |
| AX14785..... | 68 | AX15044..... | 327 | AX121273-BULK.....  | 53  |
| AX14786..... | 68 | AX15047..... | 332 | AX121273A.....      | 52  |
| AX14802..... | 68 | AX15052..... | 297 | AX121273A-BULK..... | 52  |
| AX14808..... | 68 | AX15063..... | 327 | AX121273D.....      | 66  |
| AX14809..... | 69 | AX15106..... | 299 | AX121274.....       | 53  |
| AX14810..... | 69 | AX15112..... | 322 | AX121276.....       | 53  |
| AX14811..... | 69 | AX15118..... | 316 | AX121276A.....      | 52  |
| AX14812..... | 69 | AX15155..... | 323 | AX121277.....       | 55  |
| AX14817..... | 69 | AX15156..... | 314 | AX121277B.....      | 51  |
| AX14818..... | 69 | AX15160..... | 300 | AX121278.....       | 53  |

|                    |    |                    |    |                    |    |
|--------------------|----|--------------------|----|--------------------|----|
| AX121279A.....     | 55 | AX131610.....      | 61 | AX155075.....      | 58 |
| AX121280.....      | 52 | AX131610-BULK..... | 61 | AX161571.....      | 57 |
| AX121638.....      | 52 | AX131610A.....     | 61 | AX165040.....      | 65 |
| AX121639.....      | 52 | AX131618.....      | 62 | AX165040-BULK..... | 65 |
| AX125029.....      | 67 | AX135004.....      | 61 | AX165041.....      | 65 |
| AX125037.....      | 66 | AX135042.....      | 63 | AX175005.....      | 65 |
| AX125037-BULK..... | 66 | AX135049.....      | 61 | AX175041.....      | 65 |
| AX125155.....      | 68 | AX135093.....      | 62 | AX205256.....      | 74 |
| AX125157.....      | 67 | AX135113.....      | 62 | AX721502.....      | 14 |
| AX125158.....      | 66 | AX151287.....      | 59 | AX721532.....      | 14 |
| AX125176.....      | 49 | AX151297.....      | 59 |                    |    |
| AX131599.....      | 60 | AX151297-BULK..... | 59 |                    |    |



Sacor Inc.

12-300 Steelcase Rd. W.  
Markham, ON L3R 2W2

1-800-263-3557

905-752-0146

[www.sacor.com](http://www.sacor.com)